

105B/99B

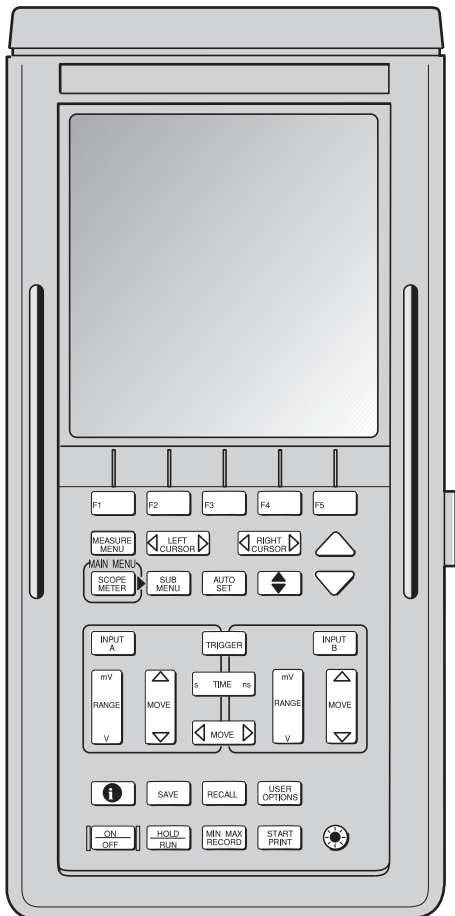

96B



92B

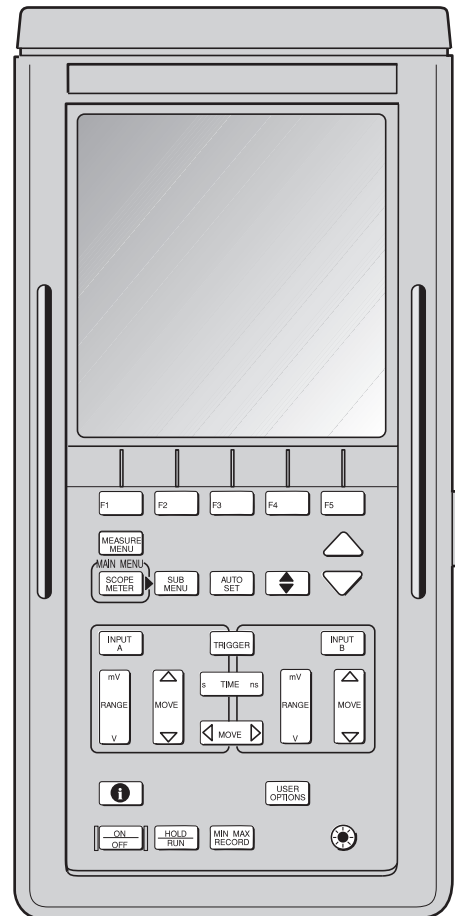

FLUKE®

92B/96B/99B/105B

ScopeMeter

Users Manual

4822 872 00724

March 1996, Rev. 4, 1/99

© 1996, 1999 Fluke Corporation. All rights reserved. Printed in the Netherlands

All product names are trademarks of their respective companies.

TABLE OF CONTENTS

CHAPTER 1	INTRODUCING YOUR SCOPEMETER® TEST TOOL	
	SCOPEMETER TEST TOOL FEATURES	1-2
	USING THE HOLSTER AND THE TILT STAND	1-3
	POWERING THE SCOPEMETER TEST TOOL	1-4
	MINIMIZING SIGNAL NOISE	1-5
	CHARGING THE BATTERY	1-6
	LOOKING AT ALL MEASUREMENT CONNECTIONS	1-7
	READING THE DISPLAY	1-8
	USING THE KEYS	1-10
	STEPPING THROUGH A WINDOW	1-12
	USING ON-LINE INFORMATION	1-13
CHAPTER 2	GETTING STARTED	
	ADJUSTING THE DISPLAY	2-3
	SELECTING THE PROBE TYPE	2-4
	POWER-ON CONFIGURATIONS	2-4
	PERFORMING AN EASY SETUP	2-5
CHAPTER 3	MAKING MEASUREMENTS	
	MAKING CONNECTIONS	3-2
	USING THE MEASUREMENT FUNCTIONS	3-3
	USING A SHORTCUT TO MOST COMMONLY MEASUREMENTS	3-9
	ORDERING MEASUREMENT READINGS	3-10
	MEASURING FUNCTIONS NOT AVAILABLE FROM THE MEASURE MENU	3-10
	MEASUREMENTS MAP	3-12

CHAPTER 4 USING THE DUAL DISPLAY MODE FUNCTIONS

MAKING CONNECTIONS	4-2
SELECTING A MAIN MODE	4-3
SELECTING RANGES (MANUAL/AUTO RANGE)	4-7
HOLDING A STABLE MEASUREMENT (TOUCH HOLD®)	4-8
DISPLAYING MINIMUM MAXIMUM READINGS WITH RELATED TRENDPLOT	4-9
SELECTING THE SCOPEMETER KEY SUBMENU	4-13
MAKING MEASUREMENTS IN METER AND EXT.mV MODE	4-14
TAKING RELATIVE READINGS (SCALING)	4-14

CHAPTER 5 USING IN SCOPE MODE

MAKING CONNECTIONS	5-3
MAKING AN EASY SETUP	5-4
CONTROLLING INPUTS A AND B	5-4
ADJUSTING THE AMPLITUDE	5-5
ADJUSTING THE TIME BASE	5-6
POSITIONING THE WAVEFORM ON THE DISPLAY	5-7
ACQUIRING WAVEFORMS	5-8
SELECTING THE SCOPE SUBMENU	5-10
TRIGGERING	5-12
USING THE MIN MAX ENVELOPE FUNCTION OF THE FLUKE 92B	5-21
USING THE SCOPE RECORD AND MIN MAX ENVELOPE FUNCTIONS OF THE FLUKE 96B, 99B, or 105B	5-22
MAKING COMBINATIONS WITH INPUT A AND INPUT B	5-26
DISPLAYING MULTIPLE WAVEFORMS	5-26
ADAPTING THE DISPLAY	5-27

CHAPTER 6 USING ADDITIONAL CAPABILITIES

MAKING MEASUREMENTS USING THE CURSORS	6-2
DELETING MEMORIES	6-6
SAVING TO MEMORY	6-7
RECALLING FROM MEMORY	6-8
USING WAVEFORM MATH FUNCTIONS	6-11
USING A PRINTER	6-14
USING THE WAVEFORM GENERATOR	6-17
TESTING COMPONENTS	6-17
SETTING THE DATE AND TIME	6-19
CHANGING THE RESET CONFIGURATIONS	6-20
ALTERING THE CONTINUOUS AUTO SET CONFIGURATION	6-22

CHAPTER 7 MEASURING EXAMPLES

MEASURING TEMPERATURE	7-2
MEASURING CURRENT	7-4
MEASURING POWER WITH MATH FUNCTION	7-7
MEASURING THREE-PHASE ON A DUAL INPUT	7-9
MEASURING PHASE USING THE CURSORS	7-12
MEASURING PULSE RESPONSE OF AN AMPLIFIER	7-14

CHAPTER 8 USER MAINTENANCE

CLEANING	8-2
KEEPING BATTERIES IN OPTIMAL CONDITION	8-2
REPLACING AND DISPOSING OF BATTERIES	8-3
REPLACING FUSES	8-5
CALIBRATING THE PROBES	8-5

CHAPTER 9 APPENDIXES

APPENDIX 9A SPECIFICATIONS	9-3
APPENDIX 9B PARTS AND ACCESSORIES	9-15
APPENDIX 9C PM8907 INFORMATION	9-19
APPENDIX 9D WARRANTY AND SERVICE CENTERS	9-21
APPENDIX 9E TERMINOLOGY	9-23

ABOUT THIS MANUAL

Chapter 1 Introducing the ScopeMeter® Test Tool

This chapter introduces features and capabilities of your ScopeMeter test tool.

Chapter 2 Getting Started

This chapter provides a 15-minute demonstration intended for those who are not familiar with the ScopeMeter test tool.

Chapter 3 Making Measurements

This chapter explores all measurements and specifies the use of the direct Measure Menu key. At any time, you can choose over 30 measurements to get an immediate reading on the display.

Chapter 4 Using the Dual Display Mode

This chapter addresses the use of four Dual Display Mode Functions of the ScopeMeter test tool: **METER**, **Ω**, **⚡**, and **EXT.mV**. You will learn how to set up the test tool for ac and dc voltage measurements, diode tests, resistance measurements, and trend plotting. Chapter 5 contains all the Scope mode information.

Chapter 5 Using the Scope Mode

This chapter explores the specific use of the test tool as a digital storage oscilloscope. You will learn how to make, store, and compare measurements.

Chapter 6 Using Additional Capabilities

This chapter explores the additional capabilities available with your ScopeMeter test tool. The chapter covers subjects, such as Scope measurements using the cursors, saving and recalling screens, waveforms, or setups, and making a hard copy on your printer.

Chapter 7 Measuring Examples

This chapter outlines step-by-step procedures necessary to make some typical measurements.

Chapter 8 User Maintenance

This chapter describes the cleaning of the ScopeMeter test tool and proper use and replacement of the battery pack. Periodic probe calibration is also covered here.

Chapter 9 Appendixes

- A. Specifications: Operating characteristics.
- B. Parts and Accessories: Model numbers and replacement codes for all parts and accessories delivered with your ScopeMeter test tool.
- C. PM8907 Power Adapter/ Battery Charger.
- D. Warranty Information and Service Centers: Warranty terms and Service Center addresses.
- E. Terminology: Glossary of special terms.

Index

The index at the end of the manual lists words alphabetically. Consult this list to find an item quickly.

NOTE

Throughout this manual an  through a model number (~~92B~~) indicates that the function being discussed does not apply to that specific model number.

UNPACKING THE SCOPEMETER TEST TOOL KIT

The following items should be included in your ScopeMeter® test tool kit (also see the yellow shipment card):

1. ScopeMeter test tool
2. NiCad Battery Pack (installed)
3. Protective Holster
4. Users Manual (this book)
5. Accessory Case, which includes the following:
 6. Set of two Probes
 7. Set of two Industrial Alligator Clips for Scope Probes
8. Multimeter Test Lead Set, which includes the following:
 9. Test Leads (red and black)
 10. Industrial Test Probes (red and black)
 11. Industrial Alligator Clip (black)
 12. Banana Adapters (red and black)
13. Power Adapter/Battery Charger
14. Probe Accessory Set, which includes the following:
 15. HF Adapters (2 x black)
 16. Mini Test Hooks (red and grey)
 17. Trim Screwdrivers (red and grey)
 18. Probe Tip to Banana Adapters (red and grey)
 19. High Voltage Test Pins (red and grey)
- 20 FlukeView™ Software with RS-232 Adapter/Cable for communication with a computer ~~92B~~ ~~96B~~ ~~99B~~.

WARNING

READ "SAFETY" CAREFULLY BEFORE USING YOUR SCOPEMETER TEST TOOL.

SAFETY

The instrument described in this manual is designed to be used only by qualified personnel.

Safety Precautions

To use this instrument safely, it is essential that operating and servicing personnel follow both generally accepted safety procedures and the safety precautions specified in this manual.









Specific warning and caution statements, where they apply, will be found throughout the manual.

Where necessary, the warning and caution statements and/or symbols are marked on the instrument.

A CAUTION identifies conditions and actions that may damage the test tool.

A WARNING IDENTIFIES CONDITIONS AND ACTIONS THAT POSE HAZARD(S) TO THE USER.

International electrical symbols used are explained below.

	Caution (see explanation in manual)		DOUBLE INSULATION (Protection Class)
	Common (Lo) input symbol, equal potential		Recycling symbol
	High BNC input symbol		DC-Direct Current
	Earth		AC-Alternating Current

The terms "Isolated" or "Electrically floating" are used in this manual to indicate a measurement in which the ScopeMeter test tool COM (common, also called ground) is connected to a voltage different from earth ground. The term "Grounded" is used in this manual to indicate a measurement in which the ScopeMeter test tool COM (common) is connected to an earth ground potential.

The ScopeMeter test tool COM (common) inputs (red INPUT A BNC shield, grey INPUT B BNC shield, and black 4-mm banana jack) are connected internally via self-recovering fault protection. The input connectors have no exposed metal and are fully insulated to protect against electrical shock. The black 4-mm banana jack COM (common) can be connected to a voltage above earth ground for isolated (electrically floating) measurements and is rated up to 600V rms above earth ground.

The ScopeMeter test tool uses a three-lead connection system for dual input, isolated (electrically floating) measurements. The connections for isolated and grounded measurements are shown in the following illustration.

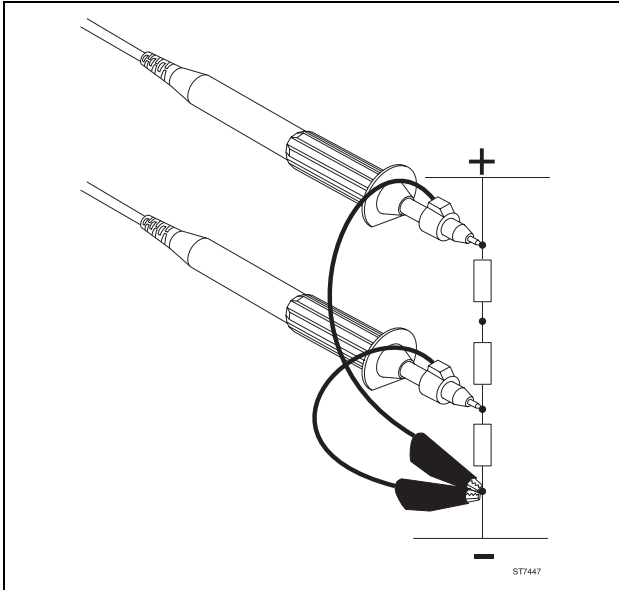





Figure 1. Common (Ground) Connections

WARNING

DO THE FOLLOWING TO AVOID ELECTRICAL SHOCK IF A SCOPEMETER TEST TOOL  COM (COMMON) INPUT IS CONNECTED TO >42V PEAK (30V RMS):

1. **USE ONLY THE TEST LEAD/PROBE SET SUPPLIED WITH THE SCOPEMETER TEST TOOL (OR SAFETY-DESIGNED EQUIVALENTS WITHOUT EXPOSED METAL CONNECTORS).**
2. **DO NOT USE CONVENTIONAL EXPOSED METAL BNC OR BANANA PLUG CONNECTORS IF THE  COM (COMMON) IS >42V PEAK (30V RMS).**
3. **USE ONLY ONE  COM (COMMON) CONNECTION (THE 4-MM BLACK BANANA JACK).**
4. **REMOVE ALL PROBES AND TEST LEADS THAT ARE NOT IN USE.**
5. **USE 600V RATED PROBE TIP ADAPTERS. "600V" IS PRINTED ON EQUIPMENT SO RATED.**
6. **CONNECT THE PM8907 POWER ADAPTER TO THE AC OUTLET BEFORE CONNECTION TO THE SCOPEMETER TEST TOOL.**

If Safety-Protection is Impaired

Use of equipment in a manner not specified may impair the protection provided by the equipment. Before use, inspect probes for mechanical damage and replace damaged probes!

Whenever it is likely that safety has been impaired, the instrument must be turned off and disconnected from line power. The matter should then be referred to qualified personnel. Safety is likely to be impaired if, for example, the instrument fails to perform the intended measurements or shows visible damage.

MAKING ISOLATED MEASUREMENTS

Isolating from Earth Ground

The ScopeMeter test tool uses a three-lead connection system for dual input, isolated (electrically floating) measurements. Use a test lead connected to the black 4-mm banana jack as common ground.

There are only three wires to connect for dual input isolated ground operation, useful for three-phase industrial voltage measurements. You can connect the three leads on the test tool (INPUT A, INPUT B, and common) to a three-phase electrical power line in any order. Use the A-B mode (see Chapter 5) to display all three phases of electrical power at the same time.

For three-phase electrical or other isolated ground industrial measurements, we strongly recommend that you use the black Industrial Alligator Clip and the red and grey Industrial Probe Alligator Clips (see Figure 4). These parts are included with original purchase ScopeMeter test tools and are also available as accessories from your FLUKE representative.

Isolating from Input to Input

The ScopeMeter test tool is not isolated between inputs but uses the black 4-mm banana jack for measurements isolated from earth ground.

Complete isolation between INPUT A and INPUT B is useful for some floating measurement applications, such as measuring different isolated transformer windings at the same time.

For those applications requiring true isolated grounds (commons) between inputs, we recommend that you make two separate measurements or use two ScopeMeter test tools.

DECLARATION OF CONFORMITY

for

**FLUKE 92B/96B/99B/105B
ScopeMeter® Series II Test Tool****Manufacturer**

Fluke Industrial B.V.
Lelyweg 1
7602 EA Almelo
The Netherlands

Statement of Conformity

Based on test results using appropriate standards, the product is in conformity with
Electromagnetic Compatibility Directive 89/336/EEC
Low Voltage Directive 73/23/EEC

Sample tests

Standards used:

EN 61010-1 (1993)

Safety Requirements for Electrical Equipment
for Measurement, Control, and Laboratory Use

EN 50081-1 (1992)

Electromagnetic Compatibility Generic Emission Standard:
EN55022 and EN60555-2

EN 50082-1 (1992)

Electromagnetic Compatibility Generic Immunity Standard:
IEC801-2, -3, -4, -5

The tests have been performed in a typical configuration.

This Conformity is indicated by the symbol , i.e.
'Conformité européenne'.

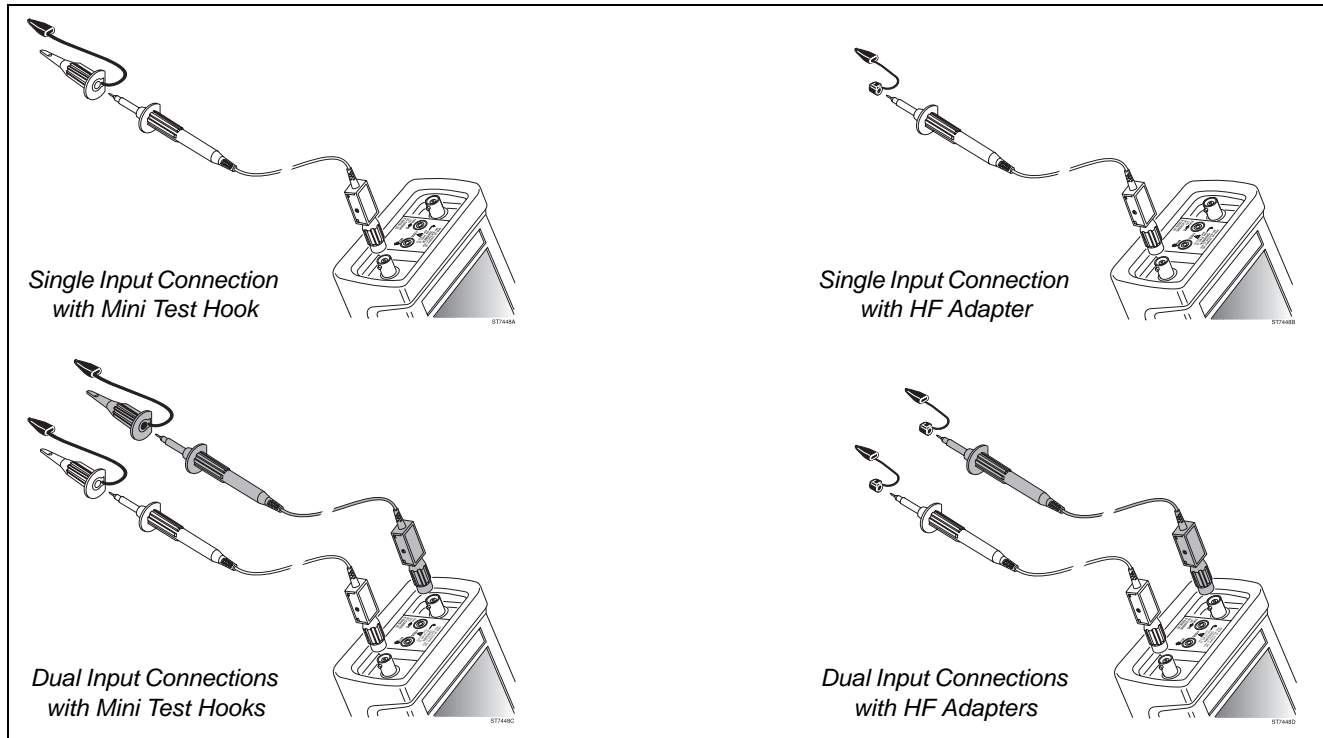

Figure 2. Input Connections for High Frequency Electronic Measurement

WARNING

To prevent electric shock and personal injury, Mini Test Hooks and HF Adapters must not be connected to any voltage higher than 42V peak (30V rms) to earth. Always pay attention to the markings on the accessories.

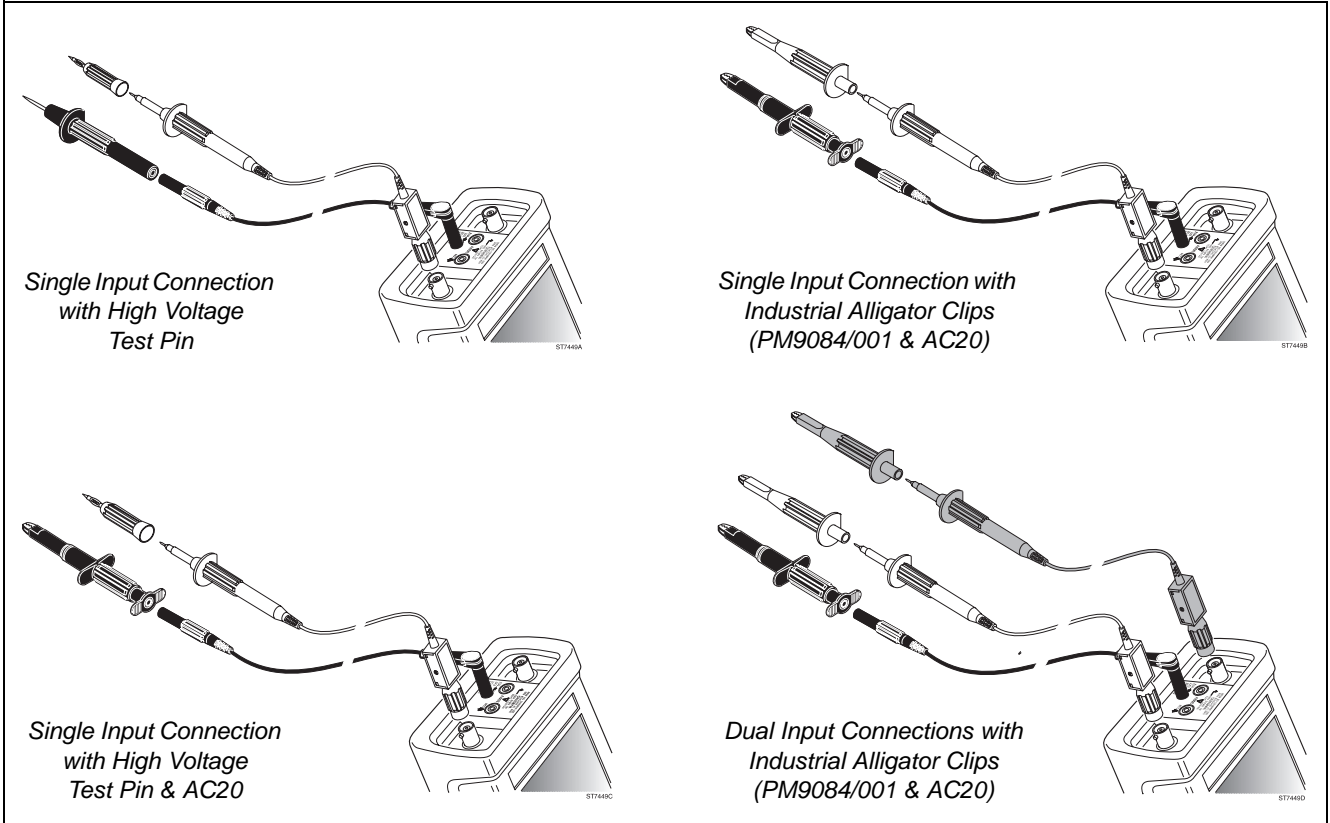

Figure 3. Input Connections for Isolated Heavy Duty Industrial Measurements

Chapter 1

Introducing your ScopeMeter[®] Test Tool

SCOPEMETER TEST TOOL FEATURES	1-2	READING THE DISPLAY	1-8
ScopeMeter Features	1-2	Reading a Dual Display	1-9
Scope Capabilities	1-2	Reading a Scope Display	1-9
Digital MultiMeter Capabilities	1-2	Reading a Window Display	1-9
USING THE HOLSTER AND THE TILT STAND	1-3	USING THE KEYS	1-10
POWERING THE SCOPEMETER TEST TOOL	1-4	STEPPING THROUGH A WINDOW	1-12
MINIMIZING SIGNAL NOISE	1-5	USING ON-LINE INFORMATION	1-13
CHARGING THE BATTERY	1-6		
Saving Battery Life	1-6		
LOOKING AT ALL			
MEASUREMENT CONNECTIONS	1-7		
Common Ground, Inputs A B	1-7		
Input/Output Terminal Ratings	1-7		
RS-232 Optical Interface Connection	1-8		

SCOPEMETER TEST TOOL FEATURES

Your ScopeMeter test tool combines the capabilities of an easy-to-use digital storage oscilloscope with the versatility of a digital multimeter. When you select a measurement function, the test tool automatically chooses the best setup to analyze and compare complex waveforms, or simply to read voltage levels.

ScopeMeter Features

- Rugged, dual-input oscilloscope and high bandwidth true RMS Meter in one instrument.
- Four hours of battery operation.
- Allows you to measure floating from mains with the 600V insulated probes.
- Optically isolated PC/Printer interface.
- Information key to access on line information on all functions.
- Separate memories for storage of waveforms, instrument setups, and screens.

Scope Capabilities

- Triggering includes external triggering and TV line selector.
- Five giga samples in recurrent mode for full resolution display of high frequency signals. (2.5 giga samples for Fluke 92B and 96B)
- Continuous Auto Set™ for hands-free probing without adjustments to test the tool.
- MIN MAX Envelope mode for recording changes in waveforms.
- ScopeRecord™ allows you to capture and view waveforms spanning 120 screens ~~92B~~.

Digital MultiMeter Capabilities

- 3000 count, 5 MHz bandwidth true RMS.
- Each Meter reading is accompanied by a Scope display.
- Displays up to four simultaneous readings.
- MIN MAX TrendPlot™ automatically graphs meter readings and shows minimum and maximum peak values with the actual or relative time.

USING THE HOLSTER AND THE TILT STAND

The ScopeMeter test tool is cradled in a holster that provides shock protection during rough handling. All keys and connections are accessible with the holster in place. You will need to remove the holster only to replace the batteries. (See Chapter 8 for battery replacement instructions.)

The test tool is also equipped with a multiposition tilt stand, allowing viewing from different angles. The stand can also be used to hang the test tool at a convenient viewing position. Simply push up on the quick release and tilt the stand. The tilt stand/bracket is fully usable with the holster in place. Typical positions are shown in Figure 1-1.

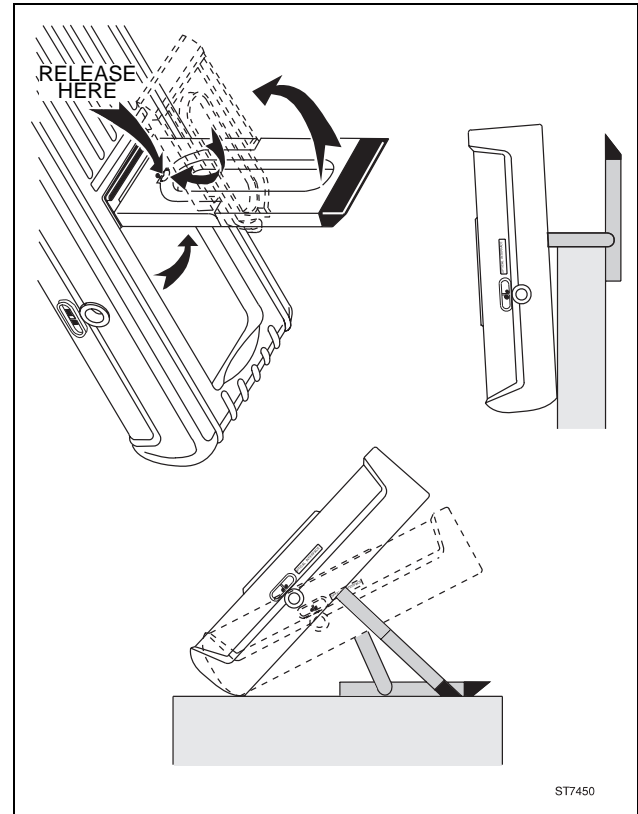

Figure 1-1. Multiposition Stand

POWERING THE SCOPEMETER TEST TOOL

The test tool can be powered from any of the following sources. Refer to Figure 1-2.

- **Internal Battery Pack (PM9086)**
A rechargeable NiCad Battery Pack comes installed in every test tool.
- **C Cell Batteries**
You can use four alkaline batteries in place of the NiCad Battery Pack. (The charger is defeated when standard C cells are installed).
- **Power Adapter (PM8907)**
The Power Adapter/Battery Charger powers the test tool from a standard ac outlet. The test tool can be used during battery charging. Verify that your local line voltage is appropriate before using the Power Adapter/Battery Charger to power the test tool and/or charge the battery pack.

See Appendix 9C for more information.

- **Automotive Adapter (PM9087, optional)**
The Automotive Adapter powers and charges from a standard 12V dc automotive accessory (lighter) outlet.

Refer to Chapter 8 for battery replacement instructions.

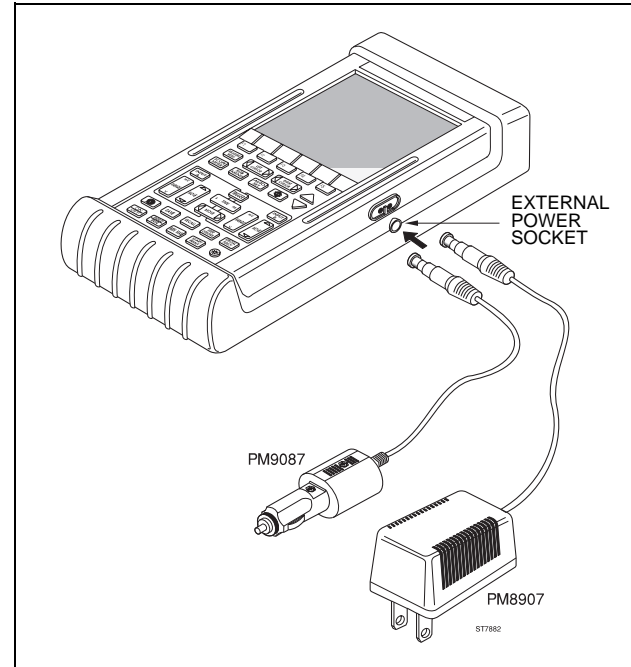

Figure 1-2. Power Connections

NOTE

If the test tool is powered with the Power Adapter but doesn't work, the batteries may be completely empty. In that case it is advised to charge the batteries for 21 hours before using the test tool.

MINIMIZING SIGNAL NOISE

In general, using your test tool on battery power only will minimize noise pickup. Using the 10:1 probe will help in noise rejection.

If you use the Power Adapter (PM8907), connect a test lead from the black 4-mm banana jack COM (common) to the measurement common (ground) of the system under test. This technique reduces or eliminates any power line related noise.

CHARGING THE BATTERY



WARNING

TO AVOID ELECTRICAL SHOCK, USE ONLY A BATTERY CHARGER THAT IS AUTHORIZED FOR USE WITH SCOPEMETER TEST TOOL.

Use the following procedure to charge the battery pack and power the instrument:

1. Connect the Power Adapter/Battery Charger to line voltage.
2. Insert the Power Adapter/Battery Charger low voltage plug into the Power Adapter connector of the ScopeMeter test tool. The test tool can now be used while the NiCad batteries charge slowly. If the test tool is turned off, the batteries charge more quickly.

NOTE

When the batteries are completely empty, the test tool can not work during charging. In that case it is advised to charge the batteries for 21 hours before using the test tool.

During operation, when the batteries are low, a blinking battery symbol  appears on the top right of the display. When this occurs there is typically more than 30 minutes of operating time left.

3. The Power Adapter/Battery Charger uses a trickle charge for the batteries, so no damage can occur if you leave it charging for long periods, e.g., through the weekend. Typically a 21-hour recharge provides 4 hours of use.

Saving Battery Life

When operated only on batteries, the test tool conserves power by shutting itself down. If no new keys have been pressed for 6 minutes or if the battery level is too low, the test tool beeps and displays a message. This prompts you to turn off the test tool or to continue. If no key is pressed during the next 5 minutes, the test tool turns itself off automatically.

When the  is pressed ON, the last configuration prior to the automatic shutdown will be restored.

Automatic power shutdown will not occur if Min Max TrendPlot™ or ScopeRecord™ is active or if any key is pressed. Although recording will continue if the batteries are low, memory retention is not jeopardized.

If the Power Adapter is connected, there is no automatic power shutdown.

LOOKING AT ALL MEASUREMENT CONNECTIONS

The ScopeMeter test tool provides four signal connection points: two safety BNC jack inputs (red INPUT A and grey INPUT B) and two safety 4-mm banana jack inputs (COM and Ω \rightarrow **EXT.mV**). This arrangement is shown in Figure 1-3. All connections are positioned within a protective recess at the top of the instrument. The banana jacks are also used as Waveform Generator Output. ~~92B 96B~~

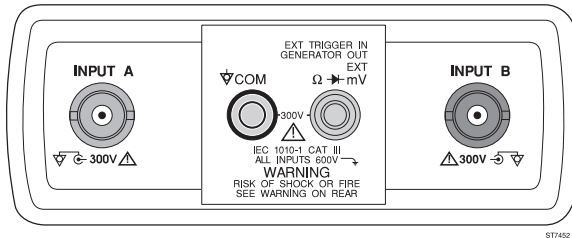

Figure 1-3. Measurement Connections

In **SCOPE** mode, you can use the red INPUT A BNC jack and the grey INPUT B BNC jack as input.

In **METER** mode, only the red INPUT A BNC jack is used as input.

In **Ω** , **\rightarrow** , and **EXT.mV** modes, use the red and black 4-mm banana jacks.

For low frequency measurements (up to about 2 MHz), ground can be connected to the black 4-mm banana jack. For higher frequencies you must use the HF Adapter or Mini Testhook on the probe.

The red 4-mm banana jack also serves as an input connection for an external trigger in Scope mode or as an output connection for the waveform generator. This waveform generator can provide voltage or current output.

Common Ground, Inputs A B

The test tool uses a three-lead connection system for dual input, isolated (electrically floating) measurements.

Input/Output Terminal Ratings

Maximum voltage ratings are defined near the related terminal. Refer to the Specifications in Appendix 10A for complete terminal rating information.

RS-232 Optical Interface Connection

The Optically Isolated RS-232 Adapter/Cable (PM9080) can be connected to the test tool for printer output and computer interface. Using the FlukeView™ software for DOS and Windows™ adds the following functionality to your ScopeMeter test tool:

- Storing of measurements in memory for later retrieval.
- Comparing of measurements with reference examples.
- Storing, analyzing, and documenting measurements.

The following table shows the printing and communication features for each model:

	92B	96B	99B	105B
Screen dump using FlukeView	●	●	●	●
Direct output to printer		●	●	●
Remote control via computer software			●	●

READING THE DISPLAY

The display provides a great deal of information. The major part of the display is always devoted to meter readings or the scope waveform. A Dual display appears in **METER**, **Ω**, **†**, and **EXT.mV** modes, and is divided into two areas: Main display and Bottom display. A Scope display appears in **SCOPE** mode, and is divided into three areas: Top display, Main display, and Bottom display.

Refer to Figure 1-4 during the following discussions.

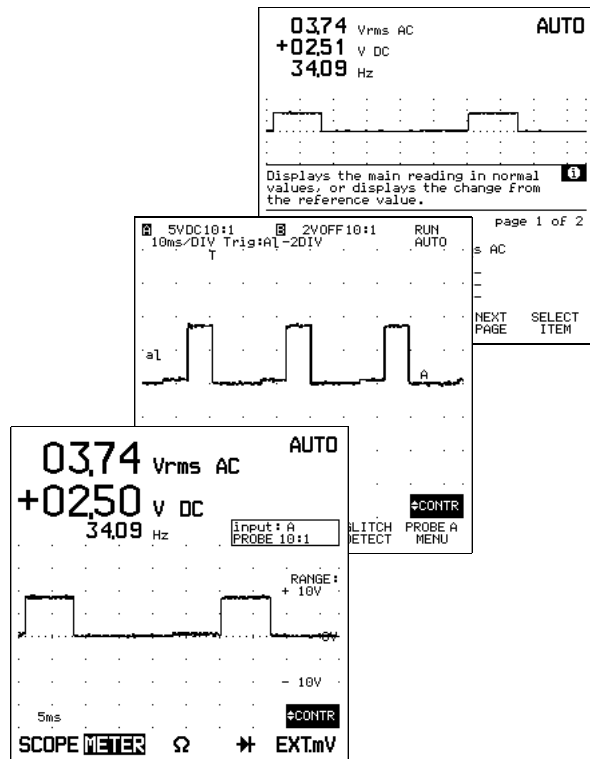

Figure 1-4. ScopeMeter Test Tool Display

Reading a Dual Display

Main Display: Displays the numeric readings combined with a full screen-width waveform display.

Bottom Display: Displays the menu that provides choices available through the function keys and shows which are active.

Reading a Scope Display

Top Display: Identifies the voltage range, type of signal coupling, selected probe type for INPUT A and INPUT B, time scale, trigger source, and trigger slope. The top right area displays the present status of the test tool, AUTO, MANUAL, RUN, HOLD, etc.

Main Display: Displays the actual or stored waveforms (Scope mode).

Bottom Display: Displays the menu that provides choices available through the function keys and shows which are active.

Reading a Window Display

When you change a setup, a part of the Main display area is used for a window. It displays choices accessed with the related function key from which you make a selection by pressing  (SELECT ITEM). The waveform area is compressed to about 50% (amplitude) size, and the window replaces the bottom half of the Main display.

USING THE KEYS

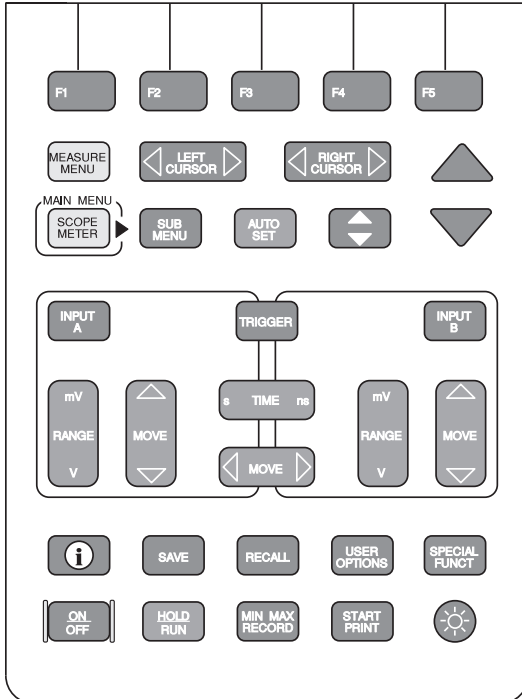

ST7988

Figure 1-5. The Keypad

The keys with a predefined function, regardless of the test tool's mode, are called keys or hard keys. Usually they give access to a menu, where items can be selected.

The two yellow keys **MEASURE MENU** and **SCOPE METER** provide the possible ways to find your measurement.

MEASURE MENU gives immediate access to a list of measurements. When you choose a measurement, the test tool automatically selects the related main mode.

SCOPE METER gives access to the Main menu. Here you can choose from the five main modes: **SCOPE**, **METER**, **Ω**, **μ**, and **EXT.mV**. Pressing **SUB MENU** gives you more control over the selected main mode.

Figure 1-6 shows the basic navigation of the test tool.

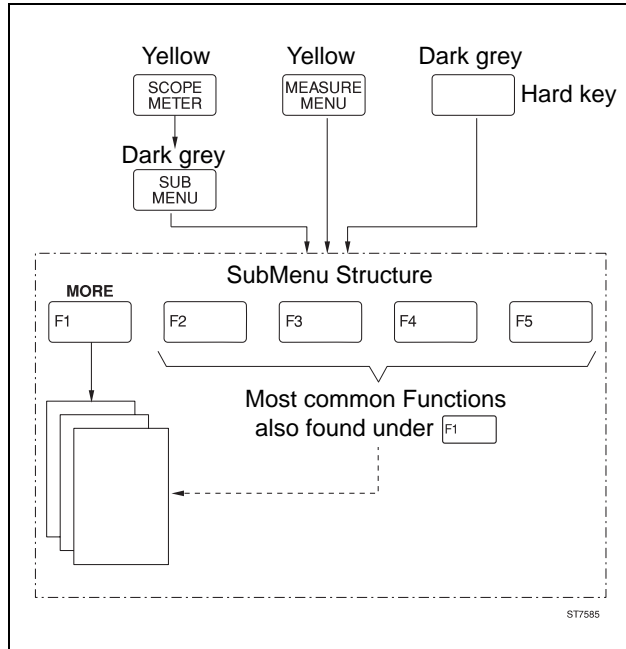



Figure 1-6. Basic Navigation

The five blue keys **F1**, **F2**, **F3**, **F4**, and **F5** are called function keys. These keys change function based on the present active menu. Actual function key definitions appear on the bottom display. Function keys and windows work together to provide a complete menu-driven user interface.

F1 is the MORE function key, which opens the window assigned to the key.

When you press the Submenu key for any main function, the **F2**, **F3**, **F4**, and **F5** keys allow immediate access to the more common functions that are also under the **F1** (MORE function key).

The   keys are used to choose an item in a box, or directly from the window. These keys are indicated by two arrows.

STEPPING THROUGH A WINDOW

When a window appears, the assignments to the function keys change as follows:

F1 is the 'CLOSE' key, which closes the active window.

F2 is the 'CANCEL' key, which ignores changed selections and closes the active window.

F5 is the 'SELECT ITEM' key, which opens and closes a list box and selects the highlighted item.

Stepping through a window has a fixed sequence as shown in Figure 1-7.

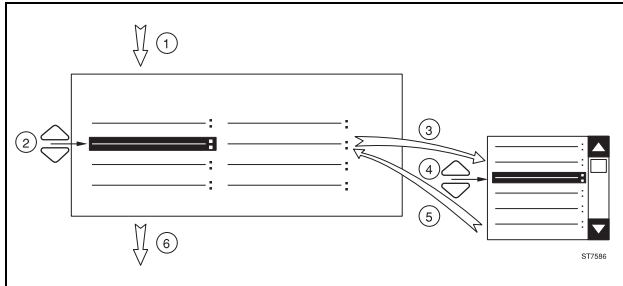



Figure 1-7. Sequence to Go Through a Window



The fixed sequence is as follows:

1. **F1** Press a MORE function key. This opens a window.

(Press **F4** (NEXT PAGE) or **F3** (PREVIOUS PAGE) to choose an item on page 2 or page 3.)

2.  or  Choose the item that has to be changed.

3. **F5** Open the list box.

4.  or  Choose the new parameter.

5. **F5** This selects the new parameter and closes the list box.

Repeat steps 2 through 5 for more items.

6. **F1** Close the window and continue measurements.

USING ON-LINE INFORMATION

You can get information about functions at any time by pressing . The short descriptions will help you understand how the test tool functions.

When you operate the ScopeMeter test tool, the display provides information about the present condition or explains procedures taking place and asks for confirmation. These messages are always displayed in a box.

More information is available by pressing . This displays one or more pages of extended on-line information. More information is available under the following conditions:



- In a menu (F1 to F5) you always can get information on the functions for every function key.
- In a window you can get more information about the highlighted function when the  icon is displayed.
- In a message you can get more information about the conflict with the present setup when the  icon is displayed. If necessary, the test tool asks for confirmation and disables the conflicting situation.

Figure 1-8 shows an example of a "function info" screen.

You can set the information level for on-line information to high or low. This is explained in Chapter 6.

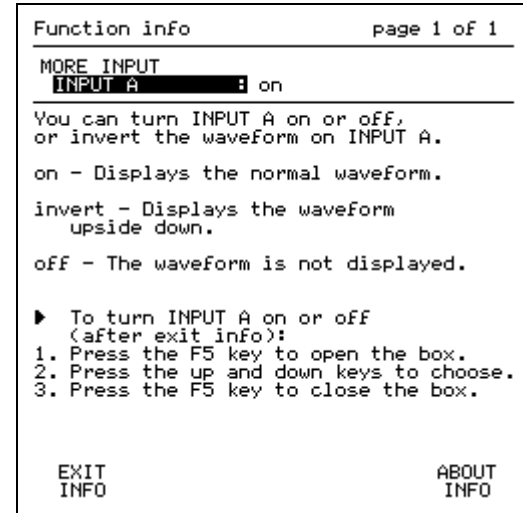



Figure 1-8. Using On-Line Information

- When you have read the displayed information, press  to exit the information mode.

This returns the test tool to the latest setup before you pressed , and you can continue your measurement.

Chapter 2

Getting Started

ADJUSTING THE DISPLAY	2-3
Adjusting the Contrast	2-3
Using the Backlight	2-3
SELECTING THE PROBE TYPE	2-4

POWER-ON CONFIGURATIONS	2-4
Master Reset (Default Startup)	2-4
Power-on/save memory	2-5
PERFORMING AN EASY SETUP	2-5

This chapter provides a 15-minute demonstration intended for those who are not familiar with the ScopeMeter test tool. It gives some hands-on experience, with an emphasis on learning by seeing and doing. Those who are familiar with the test tool can skip the following pages and continue to Chapter 3.

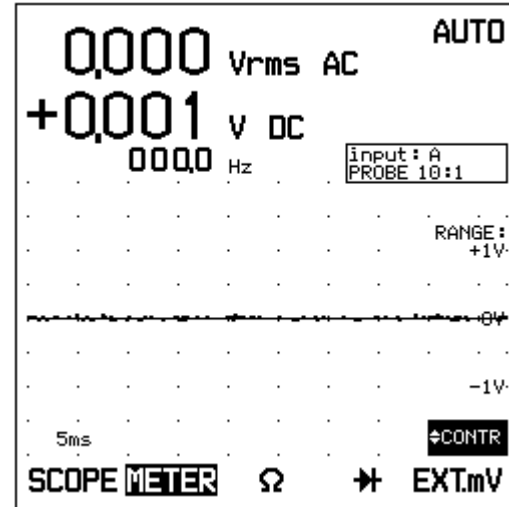

- Press  to turn on the test tool.

Operation begins in the last-known configuration. Factory default settings are used at the first power-on. Subsequent power-ons maintain configuration changes made with keystrokes or through recall of a setup memory during the previous session.



ADJUSTING THE DISPLAY

Adjusting the Contrast

- Use   to adjust the contrast of the display to your preference. Note that new contrast adjustment of the display is stored in memory until a new adjustment is made.

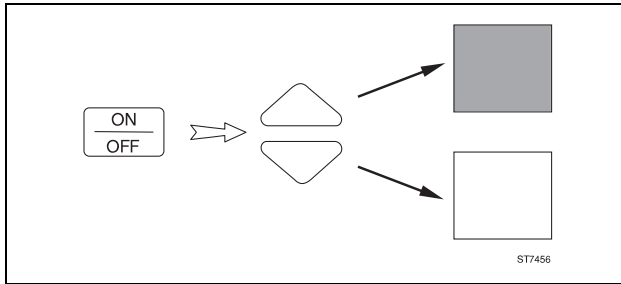







Figure 2-1. Contrast adjustment

Contrast adjustment can also be made after you have pressed , and you have highlighted the contrast with  , and pressed  to select.  is then visible in the right bottom of the display.

Using the Backlight

You can set the backlight to high or low intensity. At power-on, the backlight is set to high intensity. High intensity becomes extra high when the test tool is connected to the line power.

To set the backlight intensity, do the following:

1. Press  to set the backlight to low intensity.

If you do not set the backlight to low intensity within 5 minutes after power-on, when the testtool is battery powered, the backlight automatically switches to low intensity to save battery power.

If you want to work with a bright display, do the following:

2. Press  to set the backlight to high intensity.

The actual power source, BATTERIES or POWER ADAPTER, appears for a moment on the display. The backlight will now remain at high intensity until you set it to low intensity.

NOTE

Using the backlight at low intensity lengthens battery life.

SELECTING THE PROBE TYPE

To prevent measurement errors, ensure that your test tool is adapted to your probe at power-on. Note that the PM8918 probes, delivered with the test tool, have an attenuation of 10:1.

For accurate measurement, periodic probe calibrations are necessary. This is explained in Chapter 8, "User Maintenance".

WARNING

To prevent electric shock and personal injury, Mini Test Hooks and HF Adapters must not be connected to any voltage higher than 42V peak (30V rms) to earth. Always pay attention to the markings on the accessories.



POWER-ON CONFIGURATIONS

There are two different ways to reset the ScopeMeter test tool: the Master Reset, and the power-on/save memory.

Master Reset (Default Startup)

CAUTION

A Master Reset clears everything saved in memory. Never perform a Master Reset unless you are prepared to lose everything you saved in memory.



1. Turn the ScopeMeter test tool off.
2. Press and hold .
3. Press and release .
The test tool turns on, and you should hear a double beep, indicating the Master Reset was successful. The screen should display **input: A PROBE 10:1** on top of the waveform area.
4. Release .

Perform a Master Reset only to make sure that your test tool is in the initial settings condition. Master Reset sets the test tool for using 10:1 probes.

See Chapter 6 for more information about Master Reset conditions.

Power-on/save memory

This procedure also resets the ScopeMeter test tool and sets the probe range to 10:1. The Reset does not clear the memories.

1. Turn the test tool off.
2. Press and hold .
3. Press and release .
The test tool turns on, and you should hear a double beep. **input: A PROBE 10:1** appears on the display.
4. Release .

Use this feature when you have saved a setup, screen, or waveform in memory.

PERFORMING AN EASY SETUP

For quick operation, the test tool is equipped with a Continuous Auto Set function. This function optimizes the range and the time in all modes and assures a stable picture on nearly all waveforms. You only need to press  to activate. Once activated this function permits hands-off probing.

You can redefine the Continuous Auto Set configuration to your own preference. Refer to Chapter 6 for more information.

1.

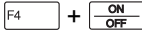

Perform a Reset at Power ON.

At power-on, all five function key definitions in the bottom display are assigned to the Main menu. Notice that **METER** is highlighted.

Ensure the probe range is 10:1, as indicated on the display.

The screen displays a True-rms AC voltage and a DC voltage in large numbers, and the frequency (in Hz) in smaller numbers. An additional scope trace gives a graphical representation of the waveform.

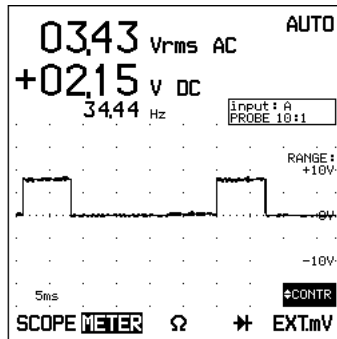

2.



Open the Measure menu; the five function keys now are assigned to: MORE MEASURE, V, Hz, dB, or TIME.

Continued on next page



QUICK MEASUREMENTS DEMONSTRATION

3.  Open the VOLT measurement menu; a list of the voltage measurements appears on the display

```

V DC          METER
Vrms AC      METER
Vrms AC+DC   METER
V DC (mean)  SCOPE
Vrms         SCOPE
Vpeak/peak   SCOPE

```

4.  +  Use these keys to choose a measurement. For now, highlight **Vrms AC+DC**.

5.  Press this function key to select Vrms AC+DC. The selected Vrms AC+DC reading appears as the main top reading on the display. The previous readings are now shifted down one. Note that the Hz has been removed.

6.  Open the TIME measurement menu; a list of the time-related measurements appears on the display.

```

CANCEL
pulse width + METER
pulse width - METER
dt            SCOPE
1/dt         SCOPE
rise time    SCOPE

```

7.  +  Choose another measurement. For now, highlight **rise time**. ~~92B~~

Continued on next page

QUICK MEASUREMENTS DEMONSTRATION

8.

Some measurements are done in another mode. This message appears in a double-lined box on the display: "This measurement is possible in SCOPE mode. Change to SCOPE mode now ?".

9.

The test tool changes automatically to the Scope mode. You can now find the Rise Time measurement result below the waveform area.

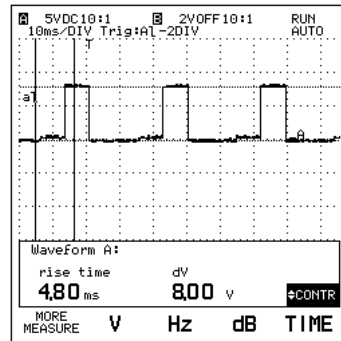
10.

The left and right cursors move across the display. The intersection of waveform and cursor mark the level for the two horizontal cursors.

This completes the Quick Measurements Demonstration; continue with the Meter Operations.

QUICK MEASUREMENTS DEMONSTRATION



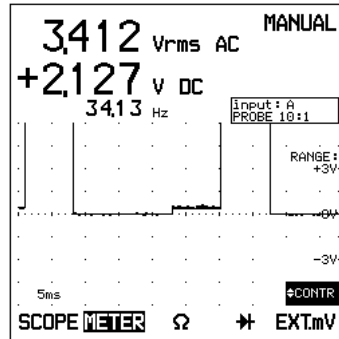

If you have not already done so, perform a + reset.

1. Input A The range increases and ranging is set to MANUAL. A Vrms AC and a V DC reading appear, and the amplitude of the graphical representation decreases.





2. Press this key once to measure a stable display. **TOUCH HOLD** appears in the top right of the display.
3. Press this key once again to resume new measurements.
4. Input A Press this key. The range decreases. If the voltage readings are overloaded, "OL Vrms AC" and "+OL V DC" appear.
5. The test tool automatically assumes a new setup that is optimized for measuring the actual input signal.



Continued on next page

6.  Open the Meter-submenu mode. The five function keys are now assigned to the meter-submenu identifiers.
7.  Open the More Meter window. The window enables you to change several settings in Meter mode.
8.  Go to the next page and find more settings that you can change.
9.  Close the window again, without changing the setup configuration of the test tool.





This completes the Meter Operations demo; continue with the Scope Operations.

PERFORMING SOME METER OPERATIONS

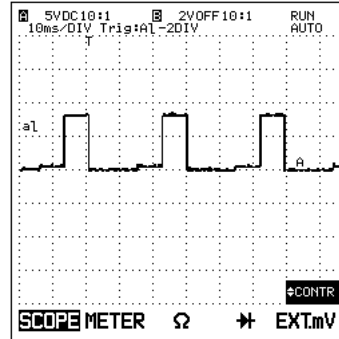
If you have not already done so perform a  +  reset.

1.   Activate the Scope Mode, then press . An image of the waveform appears on the display. The top display shows the attenuator, probe, time base, and trigger information.



2.  Input A The waveform amplitude decreases. The attenuator scale in the top display changes to a less sensitive range.
3.  The number of periods of the waveform increases. The time base scale in the top display changes to a slower time/DIV.
4.  Input A The waveform shifts upwards.
5.  The waveform shifts to the right of the display.

Continued on next page

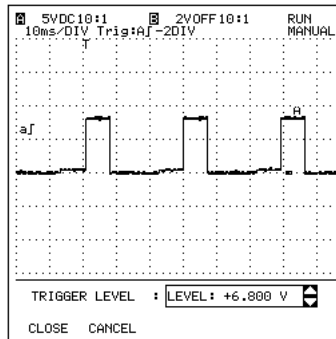

PERFORMING SOME SCOPE OPERATIONS

6. The test tool automatically selects attenuation, time base, and triggering to give you a readable display of the waveform.
7. Press this to look at the Trigger menu now.
8. This begins to display as the waveform rises above the trigger level (+SLOPE) or falls below the trigger level (-SLOPE). Watch the display; the waveform starts at a different place as trigger + or - is selected. Continue with +SLOPE selected.
9. This activates the ADJUST LEVEL function. The level value is displayed in the right bottom, and is visualized by the "a" icon on the left edge of the display. Ensure also that **RUN** is displayed in the top right of the display as an indication that your test tool is triggered.



Continued on next page

PERFORMING SOME SCOPE OPERATIONS

10.  Adjust the trigger level: the "a┘" icon moves upward as you change the trigger level. When the level is more than the waveform value, **RUN** changes into **NOTRIG**, and the display becomes unstable; your test tool is no longer triggered.
11.  Adjust the trigger level to about 50% of the waveform amplitude, so that your test tool is triggered again.
12.  Turn your ScopeMeter test tool off.

You are now able to operate basic functions in routine applications. Continue with Chapters 3 and 4 for a more detailed discussion of the ScopeMeter test tool functions.

Chapter 3

Making Measurements

MAKING CONNECTIONS	3-2
USING THE MEASUREMENT FUNCTIONS	3-3
USING A SHORTCUT TO MOST COMMONLY MEASUREMENTS	3-9
ORDERING MEASUREMENT READINGS	3-10

MEASURING FUNCTIONS NOT AVAILABLE FROM THE MEASURE MENU	3-10
Additional measurements for Meter and EXT.mV modes	3-10
Additional measurements for the Scope mode ..	3-11
MEASUREMENTS MAP	3-12

MAKING CONNECTIONS

ScopeMeter test tool measurement connections are illustrated in Figure 3-1.

Use the red INPUT A BNC jack or the red and black 4 mm banana jacks for measurements. The ScopeMeter test tool informs you when to use INPUT A or the banana jacks.

The red 4-mm banana jack is used for diode test, continuity test, Ohm measurement, and when you use a Current or Temperature probe with banana jacks.

When you use the PM8918 probe, select the 10:1 probe type for correct decimal readout.

WARNING

To prevent electric shock and personal injury, Mini Test Hooks and HF Adapters must not be connected to any voltage higher than 42V peak (30V rms) to earth. Always pay attention to the markings on the accessories.

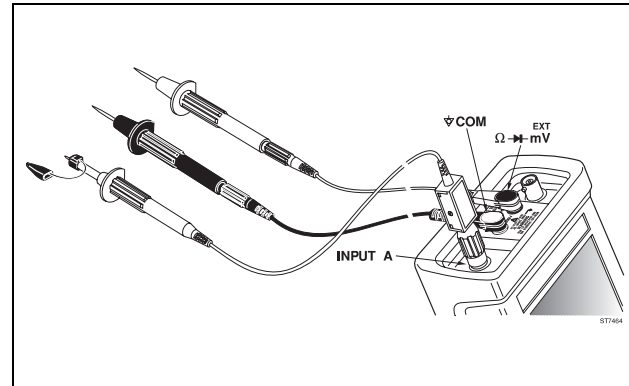
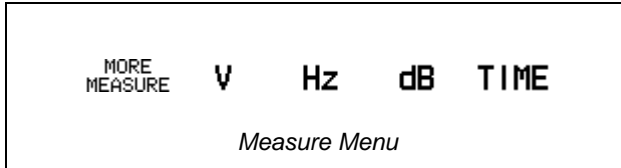

Figure 3-1. Measurement Connections

USING THE MEASUREMENT FUNCTIONS

Use the Measure menu to choose one or more automatic measurements. Simply choose your desired measurement and the test tool sets itself up and displays the result.

- Regardless of the mode you are in, press **MEASURE MENU** to access the Measure menu.





Press **F1** (MORE MEASURE) to access a multipaged (seven pages) list of all possible measurements. Press **F3** (PREVIOUS PAGE) and **F4** (NEXT PAGE) to step through the pages in the More Measure window.

OHM	METER		
DIODE	SCOPE		
CONTINUITY	METER		
%C PROBE	EXT.mV		
%F PROBE	EXT.mV		
ACCESSORY (mV)	EXT.mV		
V DC	METER		
Vrms AC	METER		
Vrms AC+DC	METER		
V DC (mean)	SCOPE		
Vrms	SCOPE		
dV	SCOPE		
Vpeak/peak	SCOPE		
Vmax peak	SCOPE		
Vmin peak	SCOPE		
dBV DC	METER		
dBV AC	METER		
A DC	METER		
A AC	METER		
A AC+DC	METER		
A DC	EXT.mV		
A AC	EXT.mV		
A AC+DC	EXT.mV		
Hz	SCOPE		
Hz	METER		
duty cycle +	METER		
duty cycle -	METER		
pulse width +	METER		
pulse width -	METER		
dBm DC	METER		
dBm AC	METER		
dBW DC	METER		
dBW AC	METER		
WATT DC	METER		
WATT AC	METER		
RPM 1	METER		
RPM 2	METER		
dt	SCOPE		
1/dt	SCOPE		
rise time	SCOPE		

ATTENTION

The listed **SCOPE** mode measurements are not available for the FLUKE 92B.

On a page, use  and  to highlight the desired measurement, then press  to select. This activates your chosen measurement and closes the window. The measurement result is instantly displayed on the screen.

See Figure 3-2 for screen examples in Dual Display mode and Scope mode.

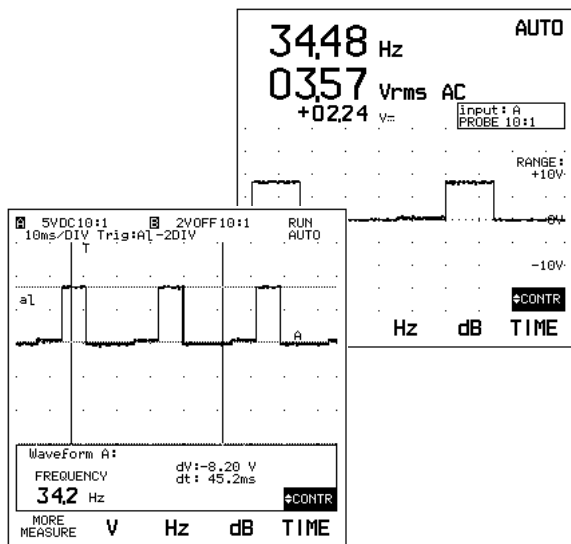



Figure 3-2. Measurement results in Dual Display mode and Scope mode

The measurements in the More Measure window are listed below.

Page 1 of 7:

OHM Ω Measure the resistor value (Ω) of a resistor connected to the red and black 4-mm banana jacks.

DIODE  Test a diode that is connected to the red and black 4-mm banana jacks. The red banana jack is the high input while the black one is the low. The result is displayed as the forward or reverse voltage of a diode.

CONTINUITY Ω Detect an open or closed circuit that is connected to the red and black 4-mm banana jacks. A beeper draws your attention when the circuit is closed.

°C PROBE **EXT.mV** Detect a temperature in degrees Celsius with a Temperature probe (optional) that is connected to the red and black 4-mm banana jacks.

°F PROBE **EXT.mV** Detect a temperature in degrees Fahrenheit with a Temperature probe (optional) that is connected to the red and black 4-mm banana jacks.

ACCESSORY (mV) **EXT.mV** Measure millivolts with an accessory that is connected to the red and black 4-mm banana jacks.

Page 2 of 7:*NOTE*

INPUT A in Meter mode can make separate V DC and Vrms AC measurements on the same signal at the same time. V DC and Vrms AC readings are normally displayed together.

V DC METER Measure the DC (direct) voltage of the input signal in Meter mode.

Vrms AC METER Measure the RMS (Root Mean Square) voltage of the input signal in Meter mode. This is done with DC- coupled input. Allows AC component of signal to be displayed

Vrms AC+DC METER Measure the true RMS (Root Mean Square) voltage of the input signal in Meter mode. If a DC-offset is present, this measurement will read higher or lower than Vrms AC. If there is no DC offset present, this measurement will be the same as Vrms AC.

V DC (mean) SCOPE Measure the mean (average of readings) value of the waveform between the (vertical) cursors in Scope mode.

Vrms SCOPE Measure the RMS (Root Mean Square) voltage of the waveform between the (vertical) cursors in Scope mode.

dV SCOPE Measure the voltage difference between the (horizontal) cursors in Scope mode.

Page 3 of 7:



V peak/peak SCOPE Measure the difference between highest and lowest voltage value of the waveform between the (vertical) cursors in Scope mode.

Vmax peak SCOPE Measure the maximum peak value of the waveform between the cursors in Scope mode.

Vmin peak SCOPE Measure the minimum peak value of the waveform between the cursors in Scope mode.

dBV DC METER (decibel Volts) Measure the voltage ratio of the DC component of a signal with respect to a reference voltage in Meter mode. This is done with DC-coupled input.

dBV AC METER (decibel Volts) Measure the voltage ratio of the AC component of a signal with respect to a reference voltage in Meter mode. This is done with DC-coupled input.

For **dBV**, you can select a range of references by pressing  or . Choose a voltage between 50 mV and 9.99V. The default value is 1V.

Page 4 of 7:

A DC METER Measure the DC current in Meter mode with a Current probe (available as an option) that is connected to the INPUT A BNC. This is done with DC-coupled input. A list box enables you to select the proper range: 1, 10, 100 mV/A, or 1 V/A.

A AC METER Measure the AC current in Meter mode with a Current probe (available as an option) that is connected to the INPUT A BNC. This is done with DC-coupled input. A list box enables you to select the proper range: 1, 10, 100 mV/A, or 1 V/A.

A AC+DC METER Measure the AC+DC current in Meter mode with a Current probe (available as an option) that is connected to the INPUT A BNC. This is done with DC-coupled input. A list box enables you to select the proper range: 1, 10, 100 mV/A, or 1 V/A.

A DC EXTmV Measure the DC current in EXT.mV mode with a Current probe (available as an option) that is connected to the red and black 4-mm banana jacks. This is done with DC-coupled input. A list box enables you to select the proper range: 1, 10, 100 mV/A, or 1 V/A.

A AC EXTmV Measure the AC current in EXT.mV mode with a Current probe (available as an option) that is connected to the red and black 4-mm banana jacks. This is done with DC-coupled input. A list box enables you to select the proper range: 1, 10, 100 mV/A, or 1 V/A.

A AC+DC EXTmV Measure the AC+DC current in EXT.mV mode with a Current probe (available as an option) that is connected to the red and black 4-mm banana jacks. This is done with DC-coupled input. A list box enables you to select the proper range: 1, 10, 100 mV/A, or 1 V/A.

Page 5 of 7:

Hz METER Measure the frequency of the input signal in Meter mode.

Hz SCOPE Measure the frequency of the waveform in Scope mode. At least $1\frac{1}{2}$ cycles of this waveform must occur between the cursors.

duty cycle + METER Measure the ratio between the time the signal is positive to the total period time in Meter mode. It is shown as a percentage figure.

duty cycle - METER Measure the ratio between the time the signal is negative to the total period time in Meter mode. It is shown as a percentage figure.

pulse width + METER Measure the duration of the average positive pulse of the waveform in Meter mode.

pulse width - METER Measure the duration of the average negative pulse of the waveform in Meter mode.

Page 6 of 7:

dBm DC METER (decibel milliwatt) Measure the power ratio of the DC component of a signal with respect to 1 mW in Meter mode. This is done with DC-coupled input.

You can choose 50, 60, 75, 93, 110, 125, 135, 150, 250, 300, 500, 600, 800, 900, 1000, or 1200Ω as reference impedance.



dBm AC METER (decibel milliwatt) Measure the power ratio of the AC component of a signal with respect to 1 mW in Meter mode. This is done with DC-coupled input. You can choose 50, 60, 75, 93, 110, 125, 135, 150, 250, 300, 500, 600, 800, 900, 1000, or 1200Ω as reference impedance.

dBW DC METER (decibel Watt) Measure the power ratio of the DC component of a signal with respect to 1W in Meter mode. This is done with DC-coupled input. You can choose 1, 2, 4, 8, 16, or 50Ω as reference impedance.

dBW AC METER (decibel Watt) Measure the power ratio of the AC component of a signal with respect to 1W in Meter mode. This is done with DC-coupled input. You can choose 1, 2, 4, 8, 16, or 50Ω as reference impedance.

WATT DC METER Measure the DC audio watts from the signal in Meter mode. This is done with DC-coupled input. You can choose 1, 2, 4, 8, 16, or 50Ω as reference impedance.

WATT AC METER Measure the AC audio watts from the signal in Meter mode. This is done with DC-coupled input. You can choose 1, 2, 4, 8, 16, or 50Ω as reference impedance.

For **dBm**, **dBW**, and **WATT**, you can select a range of references by pressing  or .



Page 7 of 7:

RPM 1 METER (revolutions per minute) Measure one count per revolution in Meter mode.

RPM 2 METER (revolutions per minute) Measure one count per two revolutions in Meter mode.

dt (delta time) SCOPE Measure the time difference between the (vertical) cursors in Scope mode.

1/dt (frequency) SCOPE Measure the relative frequency of the waveform in Scope mode. It is shown as the reciprocal value of the time difference (dt) between the vertical cursors.

rise time SCOPE Measure the rise time between 10% and 90% points of the first rising slope of the waveform in Scope mode. First use  and  to determine the 0% and 100% points of the waveform. These are the intersection of the cursors with the waveform. Set the rising slope to at least four time divisions for a precise measurement. The rise time is now instantly displayed.

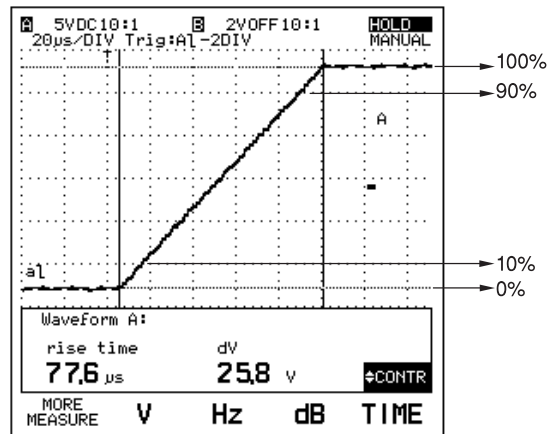
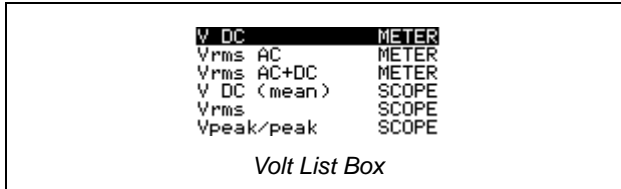

Figure 3-3. Rise Time Measurement

USING A SHORTCUT TO MOST COMMONLY MEASUREMENTS

From the Measure menu, you can also find many most commonly used measurements directly under one of the function keys **F2**, **F3**, **F4**, or **F5**. Press one of the four function keys to choose the type of measurement: V, Hz, dB, or TIME. This opens a single window with a list of measurements within the chosen type.

- Press **F2** (V) to open a list with voltage measurements:



- Press **F3** (Hz) to open a list with frequency measurements:

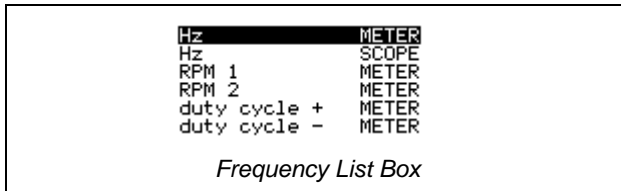

- Press **F4** (dB) to open a list with power measurements:

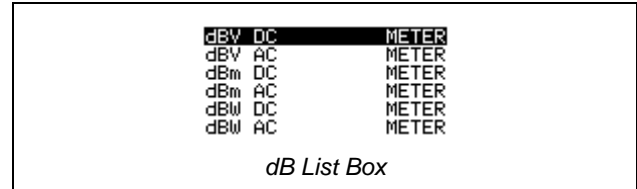

- Press **F5** (TIME) to open a list with time measurements:

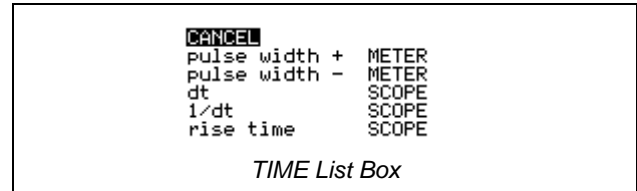

CANCEL ignores the TIME window selection and returns to the Measure menu again.

ORDERING MEASUREMENT READINGS

At default, three measurement readings are displayed at the same time, although you can display up to four readings. See Chapters 4 and 6 for more information.

When you exceed the number of selected readings, all readings shift down one and your latest chosen measurement is placed on top. Notice that the previous bottom reading is then removed.

MEASURING FUNCTIONS NOT AVAILABLE FROM THE MEASURE MENU

There are also a few more measurements that you can only find in the Scope, Meter or EXT.mV modes. These are listed below.

Chapter 4 describes how to select the Meter and EXT.mV mode measurements, and Chapter 5 the Scope mode measurements.

Additional measurements for Meter and EXT.mV modes

Vrms AC (no DC) Measure the RMS (Root Mean Square) voltage of the input signal in Meter mode. This is done with AC-coupled input so that the DC signal component is blocked and the range is optimized for the AC signal component. The V DC reading is inhibited due to AC coupling. In some cases this measurement gives one more digit of resolution over Vrms AC (DC coupled).

dBV AC+DC (decibel Volts) Measure the voltage ratio of the AC and DC components of a signal with respect to a reference voltage in Meter mode. This is done with DC-coupled input.

dBV AC (no DC) (decibel Volts) Measure the voltage ratio of the AC component of a signal with respect to a reference voltage in Meter mode. This is done with AC-coupled input so that the DC signal component is blocked and the range is optimized for the AC signal component.

dBm AC (decibel milliwatt) Measure the power ratio of the AC component of a signal with respect to 1 mW in Meter mode. This is done with DC-coupled input.



dBm AC (no DC) (decibel milliwatt) Measure the power ratio of the AC and DC components of a signal with respect to 1 mW in Meter mode. This is done with AC-coupled input so that the DC signal component is blocked and the range is optimized for the AC signal component.

dBW AC+DC (decibel Watt) Measure the power ratio of the AC and DC components of a signal with respect to 1W in Meter mode. This is done with DC-coupled input.

dBW AC (no DC) (decibel Watt) Measure the power ratio of the AC component of a signal with respect to 1W in Meter mode. This is done with AC-coupled input so that the DC signal component is blocked and the range is optimized for the AC signal component.

WATT AC+DC Measure the AC and DC audio watts from the signal in Meter mode. This is done with DC-coupled input. You can choose 1, 2, 4, 8, 16, or 50 Ω as reference impedance.

WATT AC (no DC) Measure the AC audio watts from the signal in Meter mode. This is done with AC-coupled input so that the DC signal component is blocked and the range is optimized for the AC signal component. You can choose 1, 2, 4, 8, 16, or 50 Ω as reference impedance.

For **dBV**, **dBm** and **dBW**, you can select a range of references by pressing  or .

dBV: Choose a voltage between 50 mV and 9.99V. The default value is 1V.

dBm: Choose one of the following reference impedances: 50, 60, 75, 93, 110, 125, 135, 150, 250, 300, 500, 600, 800, 900, 1000, or 1200 Ω .

dBW: Choose one of the following references: 1, 2, 4, 8, 16, or 50 Ω .

Additional measurements for the Scope mode

t1 from TRIG Measure the time difference between the trigger occurrence and the left cursor.

t2 from TRIG Measure the time difference between the trigger occurrence and the right cursor.

V1 Measure the voltage amplitude where the left cursor crosses the waveform.

V2 Measure the voltage amplitude where the right cursor crosses the waveform.

phase Measure the phase shift between two waveforms. A maximum of three phase shift measurements between the reference waveform and three other waveforms are possible.

MEASUREMENTS MAP

The measurements can be selected in various menus. The following Measurements map shows where you can find all measurements.

	MEASURE MENU	MAIN MENU				
		SCOPE	METER	Ω	\rightarrow	EXT.mV
<i>Voltage Measurements</i>						
V DC	●		●			●
Vrms AC	●		●			●
Vrms AC+DC	●		●			●
Vrms AC (No DC)			●			
V DC (mean)	●	●				
Vrms	●	●				
dV	●	●				
Vpeak/peak	●	●				
V max peak	●	●				
V min peak	●	●				
V1		●				
V2		●				
ACCESSORY (mV)	●					●
<i>Frequency Measurements</i>						
Hz (frequency)	●	●	●			●
duty cycle	●		●			●
RPM 1	●		●			●
RPM 2	●		●			●

	MEASURE MENU	MAIN MENU				
		SCOPE	METER	Ω	\ddagger	EXT.mV
Power Measurements						
dBV DC	●		●			●
dBV AC	●		●			●
dBV AC+DC			●			●
dBV AC (no DC)			●			
dBm DC	●		●			●
dBm AC	●		●			●
dBm AC+DC			●			●
dBm AC (no DC)			●			
dBW DC	●		●			●
dBW AC	●		●			●
dBW AC+DC			●			●
dBW AC (no DC)			●			
WATT DC	●		●			●
WATT AC	●		●			●
WATT AC+DC			●			●
WATT AC (no DC)			●			
Time Measurements						
pulse width	●		●			●
dt	●	●				
1/dt	●	●				
rise time	●	●				
t1 from TRIG		●				
t2 from TRIG		●				
phase		●				

	MEASURE MENU	MAIN MENU				
		SCOPE	METER	Ω	\ddagger	EXT.mV
<i>Ampere Measurements</i>						
A DC	●		●			●
A AC	●		●			●
A AC+DC	●		●			●
A AC (no DC)			●			
<i>Temperature Measurements</i>						
°C	●					
°F	●					
<i>Resistance Measurements</i>						
Ohm	●			●		
Continuity	●			●		
<i>Diode Measurements</i>						
Diode	●				●	

Chapter 4

Using the Dual Display Mode Functions

MAKING CONNECTIONS	4-2
SELECTING A MAIN MODE	4-3
SELECTING RANGES (MANUAL/AUTO RANGE)	4-7
HOLDING A STABLE MEASUREMENT (TOUCH HOLD®)	4-8
DISPLAYING MINIMUM MAXIMUM READINGS WITH RELATED TRENDPLOT	4-9
Generating a Min Max TrendPlot with the Fluke 92B	4-10
Generating a Min Max TrendPlot with the Fluke 96B, 99B, or 105B	4-10
Using 'Time from start' or 'Time of day' stamps with the Fluke 96B, 99B, or 105B	4-11
Looking at the Graphical Plot (TrendPlot™)	4-11
Stopping Recording, Freezing the Display, and Examining the Results	4-12
Examining a Record from Memory with the Fluke 96B, 99B, or 105B	4-12
SELECTING THE SCOPEMETER KEY SUBMENU	4-13
Enabling and Disabling the Change Alert™ Function	4-13
Changing the Refresh Rate of the Display	4-13
MAKING MEASUREMENTS IN METER AND EXT.mV MODE	4-14
Changing the number of readings	4-14
TAKING RELATIVE READINGS (SCALING)	4-14
Readings Relative to a Reference Point (Zero Δ)	4-14
Readings as a Percent Change from Reference Point (Zero % Δ)	4-15
Readings Displayed as a Percent of Scale (0%-100%)	4-15
Scaling in Combination with Min Max Trendplot™ Recording	4-16
Stop Scaling	4-16

MAKING CONNECTIONS

ScopeMeter test tool measurement connections are illustrated in Figure 4-1.

Use the red INPUT A BNC jack for Scope and Meter modes. Use the grey INPUT B BNC jack as a second input for Scope measurements. The red and black 4-mm banana jacks are used for Ω , μH , and EXT.mV modes.

For low frequency measurements (up to about 2 MHz), ground can be connected to the black 4-mm banana jack. For higher frequencies you must use the HF Adapter or Mini Testhook on the probe.

When you use the PM8918 probe, select the 10:1 probe type for correct decimal readout.

WARNING

To prevent electric shock and personal injury, Mini Test Hooks and HF Adapters must not be connected to any voltage higher than 42V peak (30V rms) to earth. Always pay attention to the markings on the accessories.

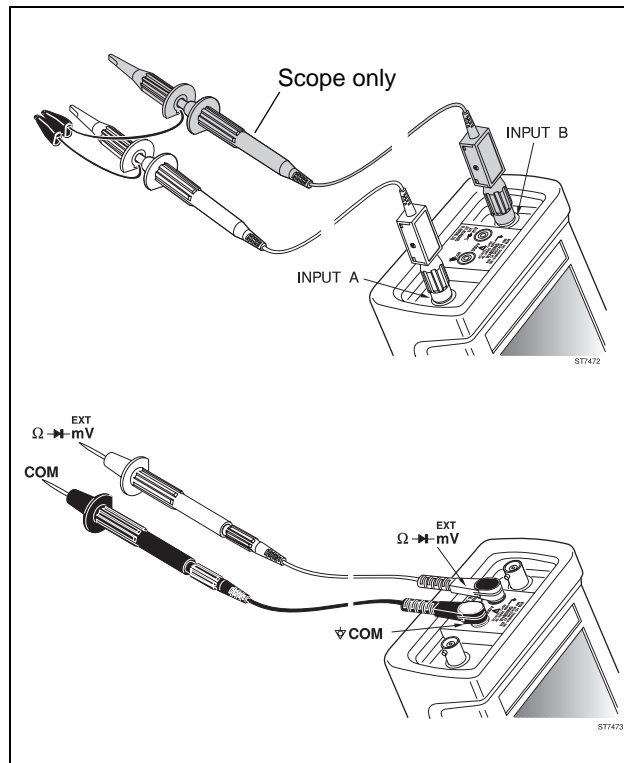



Figure 4-1. Measurement Connections

SELECTING A MAIN MODE

At power-on, the main menu at the bottom of the display is always shown. To get the main menu from another menu or screen, press .





Choose a main mode with any of the function keys: **SCOPE**, **METER**, **Ω**, **↗**, or **EXT.mV**.

The measuring result is then displayed.

 **SCOPE** INPUT A and INPUT B are used to measure the signal waveforms. You can set the amplitude of both waveforms, time base speed, and triggering for an optimum trace display. See Chapter 5 for more information about SCOPE mode.

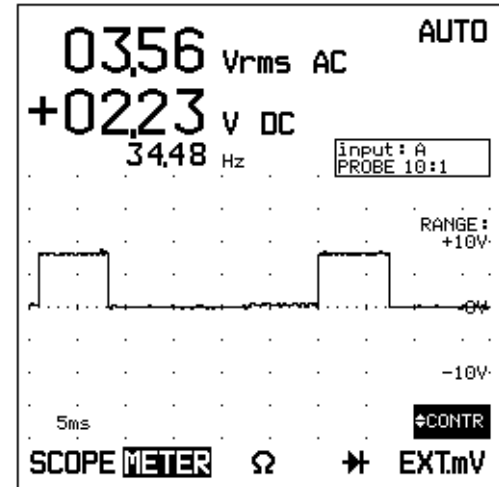
 **METER** Signals supplied to INPUT A are measured. Two measurement results appear initially on the display in a 3 2/3-digit numeric display. At the same time you find the graphic representation of the waveform in the lower display.



You can select the type and number of readings in the MORE METER window; press  and  to open the window.

If necessary, you can select the range of both the scope trace and meter display, and the time base speed.

- Press $\frac{\text{mV}}{\text{RANGE}}$ $\frac{\text{RANGE}}{\text{V}}$ to select the desired attenuation. Ranges are from 1V to 3 kV (Vrms: 2.5 kV) with 10:1 probe, or from 100 mV to 300V (Vrms: 250V) with direct 1:1 input.
- Press $\frac{\text{s}}{\text{TIME}}$ $\frac{\text{ns}}$ to select the desired time base; ranges are from 1 μ s to 100 ms/div.

F3 Ω Resistance mode. A resistor connected to the red and black 4-mm banana jack inputs is measured. The red banana jack is the high input, and the black banana jack (COM) is the low. The time base is fixed at 5 ms/DIV.

NOTE

In the diode and resistance modes, the black COMMON banana jack is not connected internally to the common of BNC INPUTS A and B.

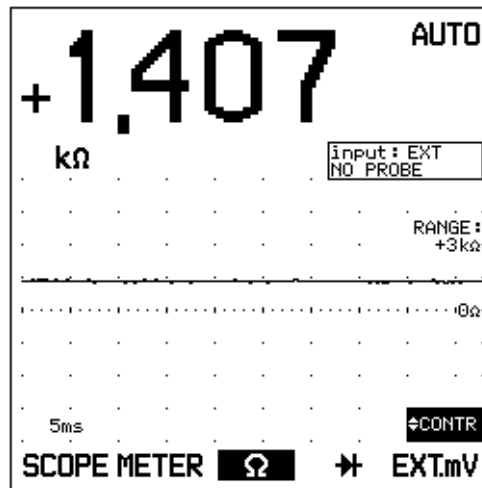

The measurement result is displayed as a 3 2/3-digit display. The ranges are 30Ω (manual only), 300Ω, 3 kΩ, 30 kΩ, 300 kΩ, 3 MΩ, and 30 MΩ. A beeper alert is generated at <5% of a selected range in Manual Range mode. The beeper alert is turned on with ALERT))).

F4  Diode test mode. A diode connected to the red and black 4-mm banana jack inputs is tested. The measurement current through the diode is 0.5 mA. The red banana jack is the high input, and the black banana jack (COM) is the low.

The result is displayed as the forward or reverse voltage of the diode. A beeper alert is generated at forward voltage. The beeper alert is turned on with ALERT))).

The time base is fixed at 5 ms/DIV and the attenuator at 3V.

NOTE

In the diode and resistance modes, the black COMMON banana jack is not connected internally to the common of BNC INPUTS A and B.

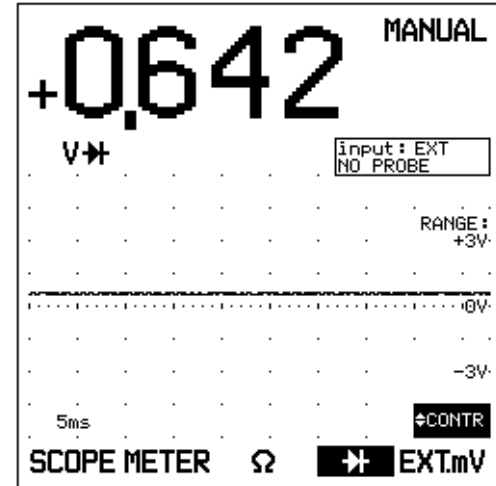



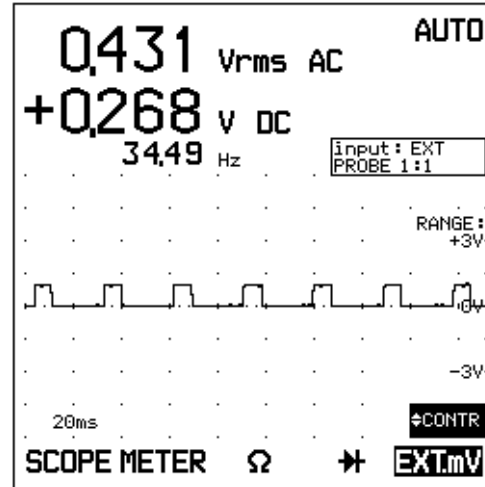

F5 **EXT.mV** EXTernal milliVolt function. Signals supplied to the red and black 4-mm banana jack inputs are measured. The red banana jack is the high input, and the black banana jack (COM) is the low. The ranges are 300 mV, and 3V. Time base ranges are from 1 μ s to 100 ms/div.

Use this mode for low voltages and for the accessories available for the ScopeMeter test tool.



SELECTING RANGES (MANUAL/AUTO RANGE)

In manual range, the input attenuator range can be changed by pressing the INPUT A  key or  , when these are assigned to . If in auto range, this switches automatically to manual range, and **MANUAL** appears in the top right of the display. The selected attenuator and time base ranges are shown on the display.

The desired time base range can be selected by pressing

.

Auto ranging (automatic setting of the attenuator and time base) is selected when you press .

HOLDING A STABLE MEASUREMENT (TOUCH HOLD®)

The Touch Hold function captures the next stable measurement and a beep indicates that a stable measurement has been made. When the Touch Hold function is turned on, the numeric display is frozen (held) until a stable measurement is detected. Stable measurements are defined as:

- Within +/-100 display counts for 1s.
- Above 200 display counts for dc signals.
- Above 300 display counts for ac signals.
- Below overload (OL) in Ω and diode test.

TOUCH HOLD appears in the top right of the display when the function is active.

NOTE

The Touch Hold function is not available in Min Max.

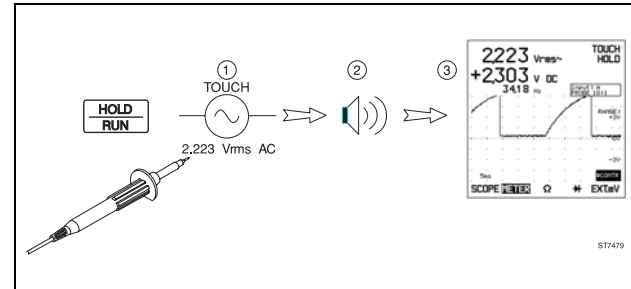

Figure 4-2. The Touch Hold function

The following procedure can be used for Touch Hold:

1. Press **HOLD RUN** and measure the signal.
2. Wait until the ScopeMeter test tool produces a beeper signal to indicate a stable signal.
3. Remove the measuring leads and read the result from the display.
4. Measure a new signal, wait for the beeper, remove the leads, and read again.
5. Press **HOLD RUN** to return to normal measurement mode.

DISPLAYING MINIMUM MAXIMUM READINGS WITH RELATED TRENDPLOT

The MIN MAX recording function is used to display several characteristics of the present main reading over time in the form of readings and a graphical plot (Min Max TrendPlot™). Five readings appear on the display (see the display example in Figure 4-3).

The top reading (in large characters) indicates the actual main reading. This is the same main reading as before MIN/MAX recording was started.

The other readings (in smaller characters) are the recorded readings with 'Time from start' or 'Time of day' stamps, as follows:

- MAX indicates the maximum reading during the recording.
- AVG indicates the average reading during recording. The AVG time stamp updates continuously.
- MIN indicates the minimum reading during recording.
- MAX-MIN indicates the difference between MAX and MIN. The Max and Min time stamps update only when new high or low readings are encountered.

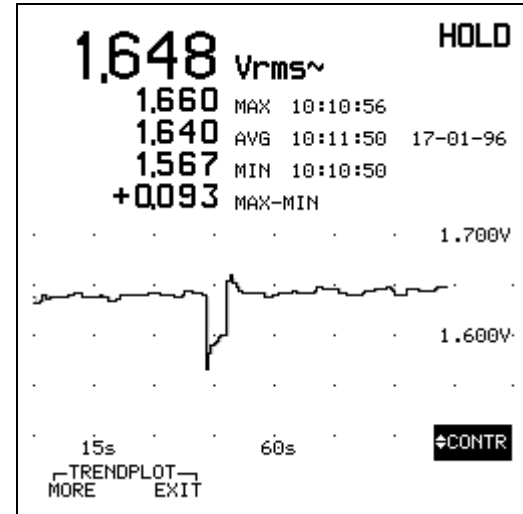

Figure 4-3. Min Max TrendPlot Example

NOTE

A beep occurs when a new MAX or MIN reading is displayed.

Generating a Min Max TrendPlot with the Fluke 92B

With the Fluke 92B, you can generate a Min Max TrendPlot of the present main reading, as follows:

1. Press **MIN MAX RECORD**.
2. A message appears on the display to make the following choice for the time stamp:
 - To select time stamps that indicate the internal clock time and date, press **F1**.
 - To select time stamps that indicate the time relative to the start of recording, press **F2**.

Recording is now in progress.

3. Press **HOLD RUN** to stop recording. The display freezes to allow you to examine the results. Notice that you can use **F1** and **F2** to change the time stamp preference selected under step 2.
4. Press **F5** to exit TrendPlot.
5. A message appears asking you to make the following choice:
 - To exit TrendPlot and to return to the function that was active before you entered the Min Max TrendPlot function, press **F1** (YES).
 - To stay in TrendPlot and keep the present record on the display, press **F2** (NO).

Generating a Min Max TrendPlot with the Fluke 96B, 99B, or 105B

With the Fluke 96B, 99B, or 105B, you can generate a Min Max TrendPlot of the present main reading, as follows:

1. Press **MIN MAX RECORD** to open the Min Max TrendPlot menu.
2. Press **F2** (START).
3. If there is still data in memory from the previous recording, a message appears asking you to make the following choice:
 - To start recording, press **F1** (YES).
 - To cancel Min Max recording and preserve the record data in memory, press **F2** (NO).
4. Press **HOLD RUN** to stop recording and to examine the results.
5. Press **HOLD RUN** a second time to start a new Min Max TrendPlot.

Using 'Time from start' or 'Time of day' stamps with the Fluke 96B, 99B, or 105B

You can select the recording time stamps to indicate the time relative to the start of recording ('Time from start') or to indicate the internal clock time and date ('Time of day').

To make this selection, do the following:

1. Press **MIN MAX RECORD** to open the Min Max TrendPlot menu.
2. Press **F1** (MORE) to open the MORE TRENDPLOT menu.
3. Use **▲ ▼** to highlight TIME REFERENCE; then press **F5** to select.
4. Use **▲ ▼** to highlight the desired setting; then press **F5** to select.

Looking at the Graphical Plot (TrendPlot™)

The test tool continuously logs the maximum, average, and minimum readings, and displays all values as a graph, as shown in Figure 4-3. Vertical scaling and horizontal time compression are automatically resized to fit the TrendPlot on the display. The TrendPlot is slowly traced on the display from left to right until the screen is written and the time scale is resized. The initial time scale is 15s/DIV; after a full screen the scale is compressed to 30s, 1 min, 2 min, etc., to a maximum of 40 days over a whole display.

ATTENTION

An overload of MAX or MIN will stop the Min Max record mode. The overloaded value (Min or Max) and the AVG are then displayed in reverse video, and the time stamp of the overloaded value is stopped. The TrendPlot will continue.

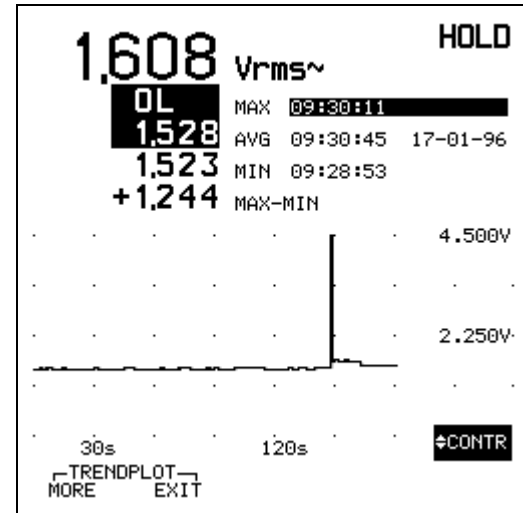





Stopping Recording, Freezing the Display, and Examining the Results

While recording is in progress, you can press  at any time to stop recording. HOLD appears in the top right of the display and the display is frozen. This allows you to examine the results.

If you press  again, the test tool starts a new Min Max TrendPlot.

Examining a Record from Memory with the Fluke 96B, 99B, or 105B

When you generate a Min Max TrendPlot, then exit this function, the record is automatically stored in memory. Also, when you turn off the test tool, the last recorded Min Max TrendPlot remains stored in memory. You can examine this TrendPlot as follows:

1. Press  to turn on the test tool.
2. Press  to open the Min Max recording menu.
3. Press  to enter the examine mode.
The display shows the last recorded Min Max TrendPlot.
4. Press  to exit the examine mode.

SELECTING THE SCOPEMETER KEY SUBMENU

From any main mode, you can access the main mode sub-menu by pressing  for more control over the selected mode. Figure 4-4 shows the METER mode sub-menu.

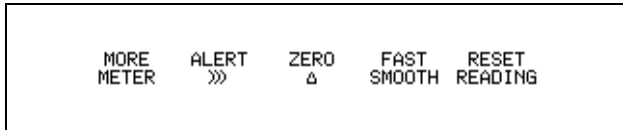



Figure 4-4. METER Mode Submenus

In **METER**, **Ω** , **μ** , and **EXT.mV** modes you can choose the functions ALERT **)))**, Zero **Δ** , FAST/SMOOTH, and RESET READING directly with one of the function keys. Or you can find these functions in the Submenu MORE window. For more information about the SCOPE submenu, see Chapter 5.

The Submenu MORE window also offers advanced measurement adaptations, such as Scaling and Value Result. To open the window, press . Make your selections and press  (CLOSE) to close the window.

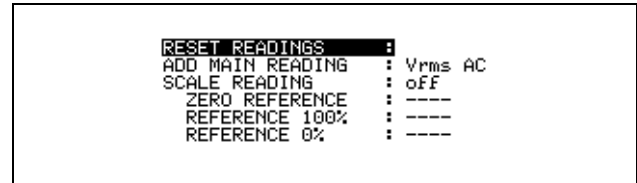





Figure 4-5. More Meter Mode

Enabling and Disabling the Change Alert™ Function

Press  to enable an audible alert signal. The test tool draws your attention with a beep when the measurement changes more than 100 digits. In **Ω** mode the alert warns you when the measurement falls to less than 5% of the measurement range.

Changing the Refresh Rate of the Display

Select  (FAST) to speed up the refresh rate in the measurement result display. A fast refresh rate is useful when you are making adjustments and must see the resulting reading as quickly as possible.

Select  (SMOOTH) to average readings over the last measurements (8 seconds at 5 ms/div). It reduces the influence of noise or unstable input signals.

Select  (no highlight) to get the normal readings.

MAKING MEASUREMENTS IN METER AND EXT.mV MODE

In Meter and EXT.mV mode you can make the same measurements as found in the Measure Menu. To find these measurements, select ADD MAIN READING in the Submenu MORE window. This opens a list of all possible measurements. For more details of the measurements, see Chapter 3.

An easy way to return to the factory default readings of the active main mode is to press $F5$ (RESET READING) from the Submenu.

Changing the number of readings

At the factory default setting the ScopeMeter test tool displays a combined numeric reading result and a waveform. You can customize the number of readings on the display from one to a maximum of four. On page 2 of the More window, highlight READINGS ON DISPLAY, select the new number 1, 2, 3, or 4, and press $F5$ to select. Then press $F1$ to remove the window again. In Ω and μ modes the maximum number of readings is two.

TAKING RELATIVE READINGS (SCALING)

Scale Main Reading displays the present measurement result with respect to a defined range. From a Submenu, press $F1$ to open a MORE functions window. Next, use \triangle or ∇ to highlight SCALE READING. When you press $F5$, a list box appears on the display to select the scaling function: off, ZERO Δ (see $F3$), ZERO $\% \Delta$, and 0%-100%. Highlight a scaling function, and press $F5$ to select.

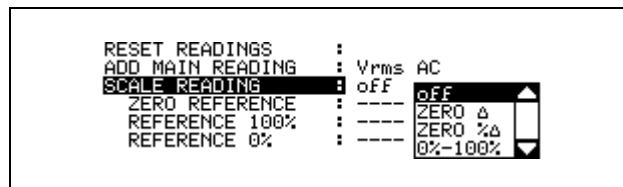

Figure 4-6. Scaling Functions

Readings Relative to a Reference Point (Zero Δ)

Select "ZERO Δ " to set the present upper reading as the zero reference point. Subsequent readings are displayed as units of variation from this point. This feature is useful when you need to monitor input activity in relation to a known good value. The zero function can also be used with dBV, dBm, or dBW.

You can also activate this function from the Submenu, and then press $F3$.

Readings as a Percent Change from Reference Point (Zero %Δ)

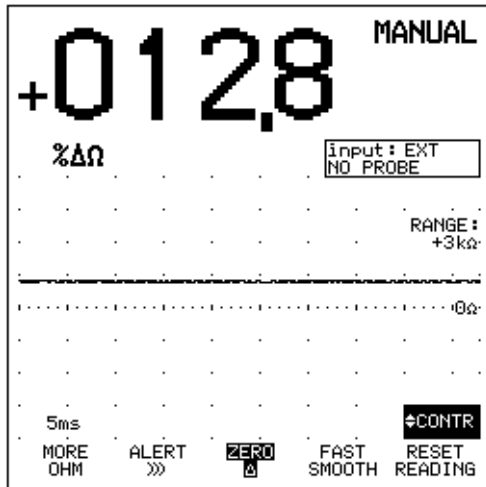

Select "ZERO %Δ" to set the present upper reading as the relative reference. Subsequent readings are displayed as a percentage of variation (delta) from this point.

The figure below shows percentage change (tolerance) when measuring a resistor:



Readings Displayed as a Percent of Scale (0%-100%)

Scaling starts automatically when both 0% and 100% values have been entered as the scaled reference values. Use the following procedure (example for Meter mode):

1. From the SCALE READING list box, highlight 0%-100% and press .
2. Use   to highlight REFERENCE 100% and press .
3. Measure the value that will represent 100%.
4. Highlight NOW (as the present 100% value) and press to save the displayed value as 100%.
5. Repeat actions 2 to 4 for the 0% value.
6. Press (CLOSE) to activate scaling and remove the window.

The present measurement result with respect to the defined range with a 0% and 100% value appears now as a scaled % readout.

A typical scaling display is shown in the figure below:

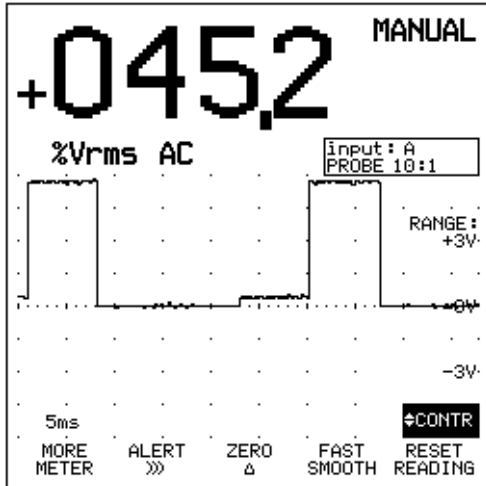

Scaling in Combination with Min Max Trendplot™ Recording

To generate a Min Max Trendplot of a scaled reading, proceed as follows:

- Select a reading you want to scale.
- Select an appropriate reference for the reading, as described in "Taking Relative Readings (Scaling)" in this chapter.
- Start the Trendplot function, as described in the previous section.

The scaled reading will now be recorded as a Trendplot that shows all deviations from the reference value over a period of time.

Stop Scaling

To stop scaling do one of the following:

- Choose another function.
- Highlight **SCALE READING** in the More window, press **F5**, highlight "off", and press **F5**.

Chapter 5

Using in Scope Mode

MAKING CONNECTIONS	5-3	SELECTING THE SCOPE SUBMENU	5-10
MAKING AN EASY SETUP	5-4	Capturing 10 or 20 Divisions	5-10
CONTROLLING INPUTS A AND B	5-4	Smoothing the Waveform (Average)	5-11
Selecting the Input	5-4	TRIGGERING	5-12
Selecting the Input Coupling	5-4	Trigger Basics	5-12
Capturing Glitches	5-5	Selecting a Trigger Source	5-13
Reversing the Polarity of		Defining the Trace Start	5-13
the Displayed Waveform	5-5	Selecting a Trigger Slope	5-13
ADJUSTING THE AMPLITUDE	5-5	Adjusting the Trigger Level	5-14
ADJUSTING THE TIME BASE	5-6	Automatic Trigger Level	5-14
POSITIONING THE WAVEFORM		Choosing a Trigger Delay	5-14
ON THE DISPLAY	5-7	The TV Triggering Function	5-15
ACQUIRING WAVEFORMS	5-8	Overview of the TV Trigger functions	5-15
Choosing Recurrent or Single Acquisition	5-8	Selecting TV System and Scan Rate	5-16
Roll Mode	5-8	Using the LINES Trigger Function	5-17
Using "Zoom" to Increase or		Using the FRAME Trigger Function	5-17
Decrease Time Resolution	5-9	Using the SELECT LINE Trigger Function	5-18
		Using the 4-field Sequence Function	5-19

USING THE MIN MAX ENVELOPE FUNCTION OF THE FLUKE 92B	5-21
Using the Min Max Envelope Function	5-21
USING THE SCOPE RECORD AND MIN MAX ENVELOPE FUNCTIONS OF THE FLUKE 96B, 99B, or 105B	5-22
Using the ScopeRecord™ function	5-23
Examining the ScopeRecord™	5-24
Using the Min Max Envelope Function	5-25

MAKING COMBINATIONS WITH INPUT A AND INPUT B	5-26
DISPLAYING MULTIPLE WAVEFORMS	5-26
ADAPTING THE DISPLAY	5-27
Selecting a Dot Size	5-27
Selecting a Display Grid	5-27
Adjusting the Trace Quality	5-27

MAKING CONNECTIONS

Scope connections are illustrated in Figure 5-1.



Maximum scope inputs on either BNC are as follows:

- Maximum input signal voltage: 300V rms direct
- Maximum input signal voltage: 600V rms when using 10:1 probe
- Voltage to ground: 600V rms

Input impedance is 10 M Ω /15 pF with the 10:1 probe.

- Press  and  to select the Scope mode.

WARNING

To prevent electric shock and personal injury, Mini Test Hooks and HF Adapters must not be connected to any voltage higher than 42V peak (30V rms) to earth. Always pay attention to the markings on the accessories.

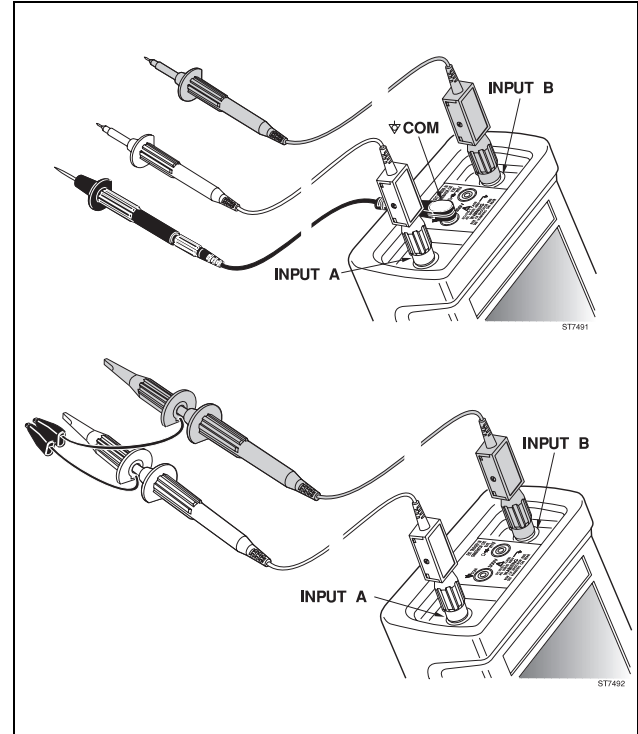





Figure 5-1. Scope Connections

MAKING AN EASY SETUP

Continuous Auto Set automatically selects the optimum settings for connected input signals and keeps track of any variation of the signal. Start Continuous Auto Set by pressing . For most signals, the ScopeMeter test tool will automatically set inputs, amplitudes, time base setting, and triggering for an optimum display.

Pressing  sets the following:

- INPUT A and/or INPUT B is switched on depending on signal input. All other waveform displays are switched off.
- Between two and five periods of the waveform with the lowest frequency are displayed.
- The attenuation per input is set so that the waveform occupies about four vertical divisions.
- The trigger source is chosen as the input signal with the lowest frequency.

If no triggerable waveform is found when you press , approximate settings are used. If the input signal subsequently changes, the test tool readjusts itself; you will always have a meaningful picture on the display.

Continuous Auto Set can be configured through the  Menu. Refer to Chapter 6 for a complete description.

CONTROLLING INPUTS A AND B

Press  or  to open the input settings menu.

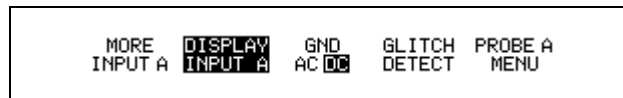



Figure 5-2. Input A Menu

Selecting the Input

Press  on the appropriate input to turn it on and off.

Selecting the Input Coupling

Press  on the appropriate input to select the input signal coupling. The selection is shown in the upper line of the top display. **AC**-coupling allows for reading ac voltages above 40 Hz only. **DC**-coupling allows for reading ac and dc voltages.

The **GND** selection disconnects the input signal and displays the ground or zero level as a horizontal line. Ground provides a useful tool for setting up the display to show a high dc level or voltage spike. For example, if you anticipate a high positive dc level, select **GND** and press  to move the ground level lower on the display. A small marker box (■) on the right side of the display identifies the ground level.

Capturing Glitches



Press **F4** on INPUT A to turn GLITCH DETECTION on. This function displays the events that occur between two samples on INPUT A. INPUT B is turned off. The events can be glitches or other asynchronous waveforms that are 40 ns (nanoseconds) or wider.

Reversing the Polarity of the Displayed Waveform

Press **F1** to open the MORE INPUT window. Highlight INPUT A (or INPUT B) and press **F5** to open the list box. You can turn on and off an input and invert the INPUT A and INPUT B display.

Invert reverses the polarity of the displayed waveform. This is identified by the trace identifier  on the display. For example, a negative-going waveform would be displayed as positive-going, providing a more meaningful viewing perspective in some cases.

ADJUSTING THE AMPLITUDE

You can use   for INPUT A or INPUT B to adjust input waveform attenuation. Sixteen ranges are available. A 1:1 probe can accommodate 1 mV to a maximum of 100V per division, and a 10:1 probe can accommodate 10 mV to a maximum of 1 kV per division. The amplitude can be changed in increments of 1, 2, and 5 (e.g., 100 mV, 200 mV, 500 mV). The upper row of the top display shows the range and the type of probe for each input.

When a 10:1 probe is used with the 10 mV or 20 mV range, averaging is turned on automatically. (**AVG 4** appears on the display.)

ADJUSTING THE TIME BASE

Press **s TIME ns** to increase or decrease the number of periods. The time base readout is on the second row of the top display. Refer to Figure 5-3. Available settings depend on the acquisition mode in effect, and are as follows:

- Recurrent 5ns (10ns)/DIV - 1s/DIV *
 - Single 100ns/DIV - 1s/DIV
 - Roll 2s/DIV - 60s/DIV
- * Fluke 92B and 96B : 10ns/DIV
 Fluke 99B and 105B : 5ns/DIV



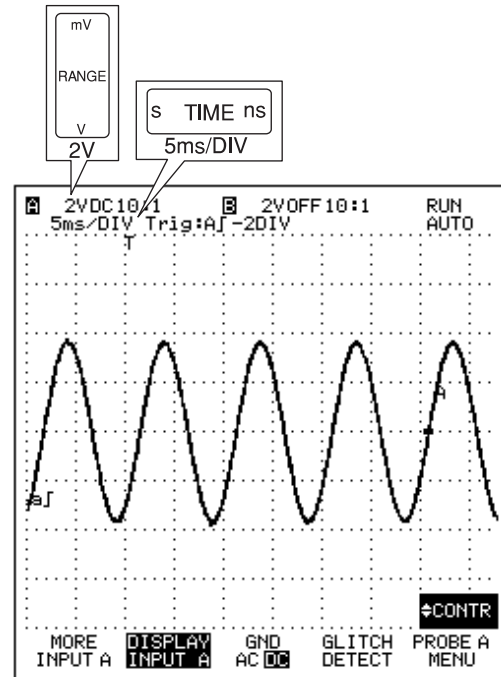

The time base can be changed in increments of 1, 2, and 5 (e.g., 10 ns, 20 ns, 50 ns).



ST7494

Figure 5-3. Time Base and Amplitude Adjustment

POSITIONING THE WAVEFORM ON THE DISPLAY

Considerable flexibility is offered in moving the trace(s) around the display.  and  reposition the trace up or down maximum four divisions. This operation can be done separately for each input. The   key simultaneously repositions all traces left or right from -4 to +16.5 divisions. Waveform positioning is demonstrated in Figure 5-4.

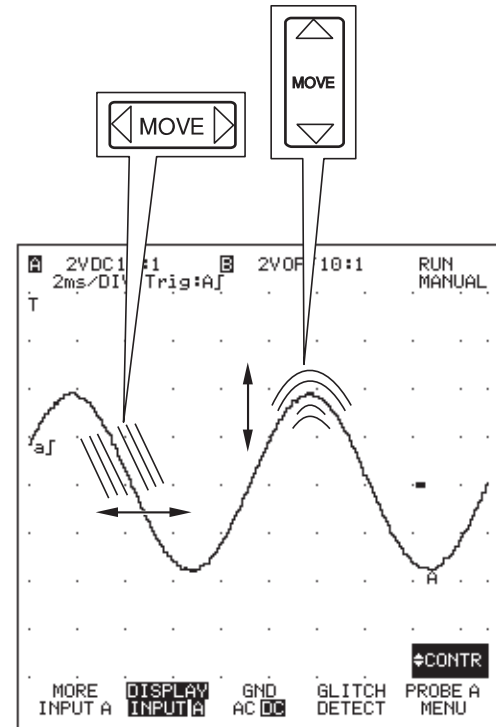

ST7495

Figure 5-4. Positioning the Waveform

ACQUIRING WAVEFORMS

Choosing Recurrent or Single Acquisition

You can instruct the ScopeMeter test tool to continuously update its display, giving you a dynamic look at waveform activity as it occurs (**RECURRENT**). You can also tell the test tool to update its display only once, yielding a snapshot record of waveform activity (**SINGLE**), termed "Single-Shot" elsewhere in this manual.

From the Scope Submenu, press to highlight **RECURRENT** for continuous display updates. Pressing stops and starts an acquisition. A **HOLD** on the top right of the display indicates that acquisition is stopped. The time base range is 5ns (10ns)/DIV to 1s/DIV.

Set up the ScopeMeter test tool for "Single-Shot" acquisitions with the following procedure:

1. Press to select **SINGLE** (highlighted). **NO TRIG** begins flashing on the display. The instrument is waiting for a trigger.

RUN appears on the display when the single acquisition is triggered. **HOLD** then reappears when acquisition is completed.

2. Now press again and wait for another single acquisition trigger.

The time base range is 100ns/DIV to 1s/DIV.

Roll Mode







Roll mode supplies a visual log of waveform activity and is especially useful when measuring lower frequency waveforms. To enter the Roll mode, press to select **RECURRENT**, then press to select 2s/DIV, 5s/DIV, 10s/DIV, 20s/DIV, or 60s/DIV.

The waveform is now slowly traced on the display from left to right until the full screen is written. Then the trace slowly shifts from right to left like a pen-recorder. The Roll mode is automatically turned off if a time base of 1s/DIV or faster is selected.

Roll is an untriggered mode. The Capture length and Single-Shot functions are not available. However, the waveform can be frozen on the display by pressing .

Using "Zoom" to Increase or Decrease Time Resolution

Zoom displays a waveform with increased time resolution, giving up to 1000x magnification. Use the following procedure to Zoom in a waveform:

1. Press 
2. Use the  and  keys to highlight "scope zoom".
3. Press  to select. **←ZOOM** appears in the right bottom of the display.
4. Press  to enlarge the waveform (speed up the time base) or press  to shrink the waveform (slow down the time base).

The ScopeMeter test tool zooms in and out one step at a time and, if necessary, the trigger delay is recalculated. The focal point for this activity is waveform activity at the fourth time division. The zoom feature is useful as a quick examination of a live waveform. Zoom cannot be used on saved waveforms recalled from memory or when the waveform is frozen (HOLD).

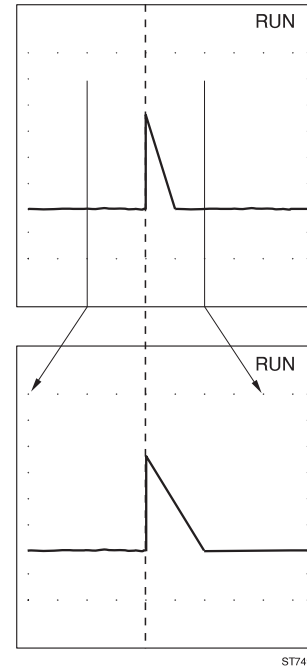

Figure 5-5. Zoom in a Waveform

SELECTING THE SCOPE SUBMENU

From the Scope mode, press to open the Scope mode submenu. This gives you more control over the Scope mode. Figure 5-6 shows the Scope Submenu.

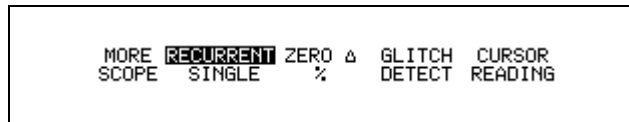

Figure 5-6. Scope Submenu

Refer to Chapter 6 for descriptions of the (ZERO Δ) and (CURSOR READING) function key.

The MORE Scope window gives you access to all control over the Scope mode. In addition to the functions shown in Figure 5-6, you will also find functions, such as Capture Length, Average Waveforms, and Scope measurements. To use these functions, press to open the MORE SCOPE window.

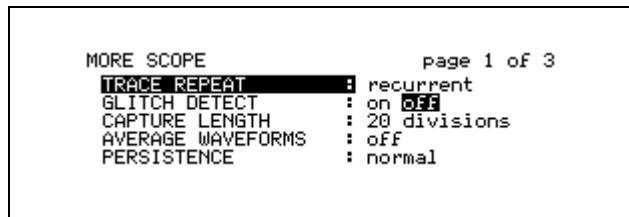

Figure 5-7. More Scope Window

Capturing 10 or 20 Divisions

This enables you to capture either 10 or 20 divisions of waveform detail.

Selecting 10 divisions, or one full screen, is sufficient for most applications.

For fast single shots, selecting 20 divisions enables you to capture more information, but on slow waveforms it lowers the screen update speed by a factor of 2. Now you can use to move the acquired waveform right and left across the display.

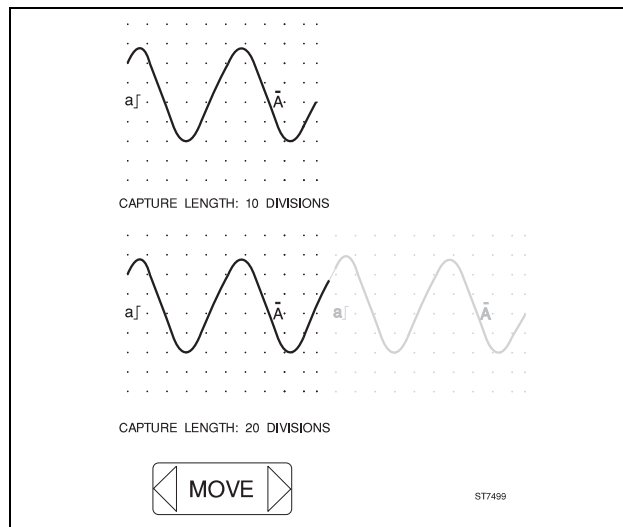

Figure 5-8. Capture length

Smoothing the Waveform (Average)

The test tool can average multiple samples of a waveform, allowing for noise suppression without loss of bandwidth. To select average in the Scope mode, do the following:

1. From the More Scope window, highlight AVERAGE WAVEFORMS.
2. Press to open the list box.
3. Use to choose the number of waveforms to average for each display update. The maximum number is 256.
4. Press to select.
5. Press (CLOSE) to close the window.

To turn off averaging, set AVERAGE WAVEFORMS to be off again.

NOTE

AVERAGE WAVEFORMS: OFF changes to **AVERAGE WAVEFORMS: by 4** in the 10 mV and 20 mV attenuator ranges when a 10:1 probe is used.

Additional information about smoothing appears in Chapter 6. Waveform samples with and without averaging are shown in Figure 5-9.

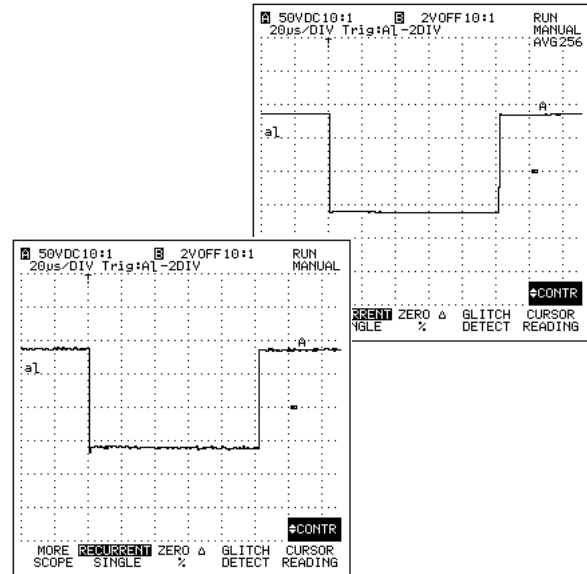

Figure 5-9. Averaging

TRIGGERING

Trigger Basics

Triggering tells the ScopeMeter test tool when to begin displaying the waveform. You can select which input signal should be used as the source, on which edge this should occur, and at what waveform level it should occur. Finally, you can tell the test tool to delay the waveform to be displayed with a specified time delay, number of cycles, or number of events.

The second top row on the display identifies the trigger parameters being used. Trigger icons on the display indicate the position of the trigger delay and the trigger level. Refer to Figure 5-10.

For example,

20 ms/DIV TRIG:A \lceil +120EVT -5DIV

means that INPUT A is used as the trigger source with a positive slope. The amount of trigger delay in time divisions is -5, and that the amount of trigger delay in events is +120.

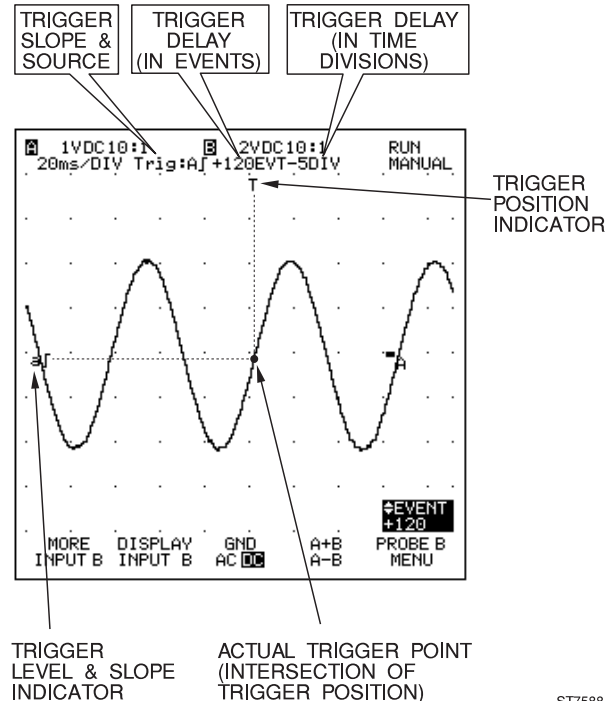

ST7588

Figure 5-10. Display with All Trigger Information

- Press to open the Trigger menu.

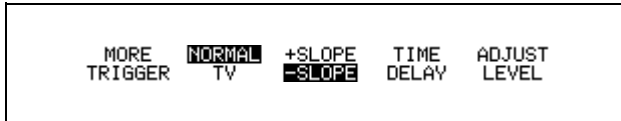

Figure 5-11. Trigger Menu

Selecting a Trigger Source

Press to enter the MORE TRIGGER window, then highlight TRIGGER SOURCE and press to open the list box. Select one of the following trigger sources: INPUT A, INPUT B, EXTERN 2V (via external trigger input), EXTERN 0.2V (via external trigger input), or GENERATOR ~~92B~~ ~~96B~~ (via internal waveform generator).

NOTE

You can also find the trigger source selection under the appropriate INPUT A or INPUT B More window.

- EXTERN 2V or EXTERN 0.2V are available as trigger source selections. You can connect an external trigger at the red 4-mm banana jack. Make your selection for the appropriate TTL-compatible (Transistor-to-Transistor Logic) trigger level (0.2V or 2V).

- GENERATOR ~~92B~~ ~~96B~~. See Chapter 6 for more information.

NOTE

EXTERN and GENERATOR are mutually exclusive; selecting one deactivates the other.

Defining the Trace Start

In the MORE TRIGGER menu, highlight TRACE START and press to open the list box.

When **Wait for trigger** is selected, the test tool needs a trigger to display a waveform.

When **free run** is selected, and if no trigger is detected for 100 ms, the test tool provides its own trigger and the trace still appears on the display. Use this mode for a continuous display of a waveform.

Selecting a Trigger Slope

From the Trigger menu, press to select triggering on either the +SLOPE or -SLOPE of the chosen input.

Adjusting the Trigger Level

To adjust the test tool's trigger level, do the following:

1. Select INPUT A or INPUT B as trigger source. (The trigger levels of the other sources are fixed.)
2. Press to open the ADJUST LEVEL box. Use and to adjust the trigger level. Observe the trigger icon (e.g. a \int) as you adjust the trigger level.
3. Press to accept the selected trigger level.

Automatic Trigger Level

To give you a stable display, the ScopeMeter test tool can find the best trigger level automatically. To activate this feature, press to open the ADJUST LEVEL box; then press a second time to select AUTO LEVEL. Press to accept the selection.

The trigger level will now be set and continuously adjusted to the optimal level, even when the signal changes.

Choosing a Trigger Delay

You can also begin to display the waveform at some time before or after the trigger point is detected. This is identified by the delay icon "T" on the top of the display.

From the second page of the MORE TRIGGER window, select RESET DELAY to reset all the selected trigger delays to their initial values (TIME DELAY : -2, TRIGGER SPECIAL DELAY: OFF).

Types of trigger delays are discussed below. In many instances, you can select more than one type of delay.

Press to enter the Time Delay list box. Use or to set the trigger time delay in increments of the existing time base divisions. The range of divisions is -20 to +640. For example, if the time base is set to 2ms/DIV, +16 defines a delay of 16 time divisions (32 milliseconds) after the trigger is detected. Press to accept the new delay.

From the second page of the MORE TRIGGER window, select TRIGGER SPECIAL DELAY (off, Events, or N-Cycle).

N-CYCLE The trigger waveform is divided by the number of cycles "N" to create a stable picture for waveforms with a cyclic character. (N-CYCLE can be used only on INPUT A.) Use or to select the number of cycles. A total of +2 to +255 cycles can be selected.

EVENTS Triggering via the external input is delayed for a number of events that occur on INPUT A. Use or to select the number of events (+1 to +1023). External trigger starts the delay, and after the number of events on INPUT A is equal to the selected number, the test tool acquires the INPUT A signal.

The TV Triggering Function

The TV trigger function allows you to examine frames, fields, and lines of TV signals for various TV systems.

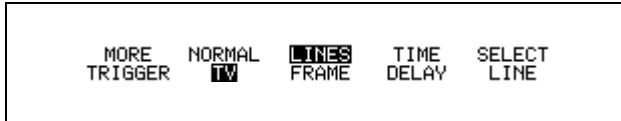

Figure 5-12. TV Trigger Menu

Overview of the TV Trigger functions

To use the TV trigger function, press **TRIGGER**; then press **F2** to open the TV trigger menu shown in Figure 5-12. You can select one of the following three TV trigger functions:

1. **LINES** is used to trigger on the synchronization pulse of all lines (horizontal synchronization).
2. **FRAME** is used to trigger on the synchronization pulse of frames (vertical synchronization). With a low-speed time base (10 ms/div) you can look at a full frame. With a high-speed time base (10 μ s/div) you can look at line #1.
3. **SELECT LINE** is used to select the line number within frames.

TIME DELAY is used to shift the beginning of the waveform display at some time before or after the trigger point in all trigger functions.

Selecting TV System and Scan Rate

Before using TV triggering, make sure that the test tool is set for the correct TV system and scan rate.

The TV system setting is shown at the top of the display, as shown in Figure 5-13.

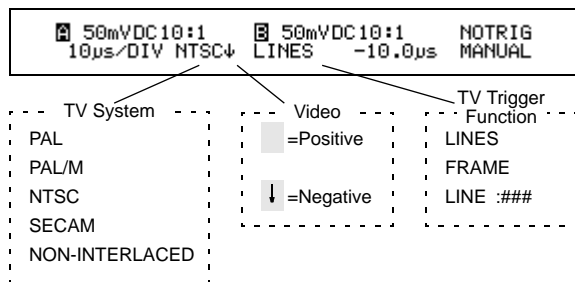

Figure 5-13. TV system and trigger function indicator

To verify or change TV trigger settings, do the following:

1. From the TV Trigger Menu (see Figure 5-12):
Press **F1** to display the TV trigger settings in the MORE TRIGGER menu.
This menu lists all of the present TV trigger settings.
2. Use **↑** **↓** to highlight the setting to be changed; then press **F5** to select.
3. Use **↑** **↓** to highlight the desired setting; then press **F5** to select.

NOTE

If the TV trigger settings are incompatible with the TV system under test, the test tool might not display a stable picture or might select a wrong line number.

Using the LINES Trigger Function

With this function, all lines are displayed. The test tool triggers on the horizontal synchronization pulse (line sync).

To activate the LINES trigger function, open the TV trigger menu (see Figure 5-12); then press to highlight LINES. The top of the display now indicates the Lines function (see Figure 5-13).

Using the FRAME Trigger Function

With this function, the test tool triggers on vertical synchronization pulses (frame sync).

To activate the FRAME trigger function, open the TV trigger menu (see Figure 5-12); then press to highlight FRAME. The top of the display now indicates the Frame function (see Figure 5-13)

Using the SELECT LINE Trigger Function

With this function, the test tool can trigger on any specific line in a frame.

To select a line, refer to Figure 5-12 and do the following:

1. From the TV Trigger Menu, press (SELECT LINE) to display the select line menu (see Figure 5-14).

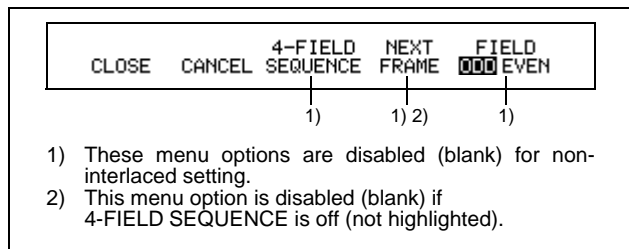
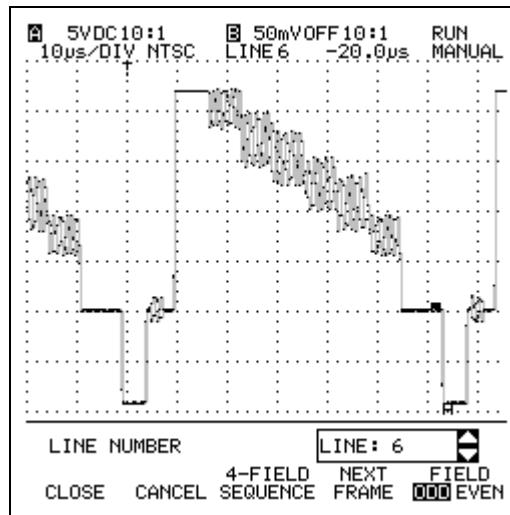

Figure 5-14. SELECT LINE menu

2. Use to select a line number.
3. If you have selected an interlaced TV system in the MORE TRIGGER menu, you can press (ODD / EVEN) to swap between a line in the odd field and its corresponding line in the even field. The line counter decreases or increases accordingly.







NOTE

When you have selected 'TV System: Non-interlaced' in the MORE TRIGGER menu, the ODD and EVEN FIELD selection is disabled (not visible on the display shown in Figure 5-14).

NOTE

When viewing signals from an interlaced video system, you may need to use the 4-field sequence function to get a stable display, as described in the next section, "Using the 4-Field Sequence Function".

4. To begin the waveform display at some time before or after the trigger point, press  (TIME DELAY) on the TV trigger menu; then use   to increase or decrease the time delay. Note that the waveform shifts to the right or the left while doing so. To return to the original time delay, press .

Using the 4-field Sequence Function

In interlaced video systems the color information in a selected line may be alternating between two phases or between two amplitudes. This depends on the video system under test. If you use the 4-field sequence function, each second frame is discarded (i.e. the test tool displays the line in a 4-field sequence) and the alternating image gets stable. Using the AVERAGE WAVEFORM function (under the  key), with the 4-field sequence function gives you more accurate measurements.

Figure 5-15 shows the effect of the 4-Field Sequence and Next Frame functions on a color burst display.

To use the 4-field sequence function, do the following:

1. From the TV trigger menu, press (4-FIELD SEQUENCE).

NOTE

When you have set 'TV system: VIDEO Non-interlaced' in the MORE TRIGGER menu, the 4-FIELD SEQUENCE menu option is disabled (not visible on the display shown in Figure 5-14).

2. To look at the other phase or amplitude, press (NEXT FRAME). The 4-field sequencer then triggers on the other frames and discards the previous frames.

NOTE

The NEXT FRAME function is not available (not visible on the display) when 4-FIELD SEQUENCE (F3) is off (not highlighted on the display shown in Figure 5-14).

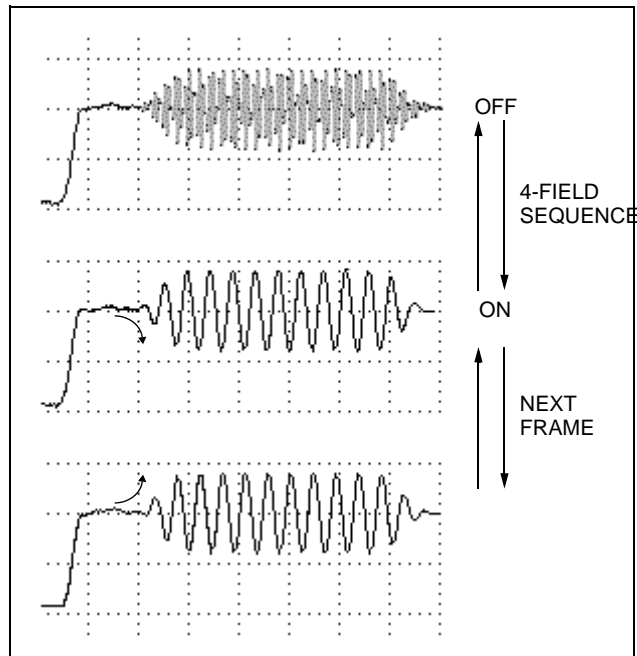



Figure 5-15. Measuring a color burst with 4-FIELD SEQUENCE and NEXT FRAME functions

USING THE MIN MAX ENVELOPE FUNCTION OF THE FLUKE 92B

This function displays changes in the shape of a waveform as a grey area around the actual trace. It keeps track of minimum and maximum values that occur over time.



Using the Min Max Envelope Function

To use this function, do the following:

1. Press .

NOTE

Any change in attenuation or time base will start a new Min Max envelope recording.

2. To turn off Min Max envelope recording, do one of the following:
 - Press  a second time.
 - Press .

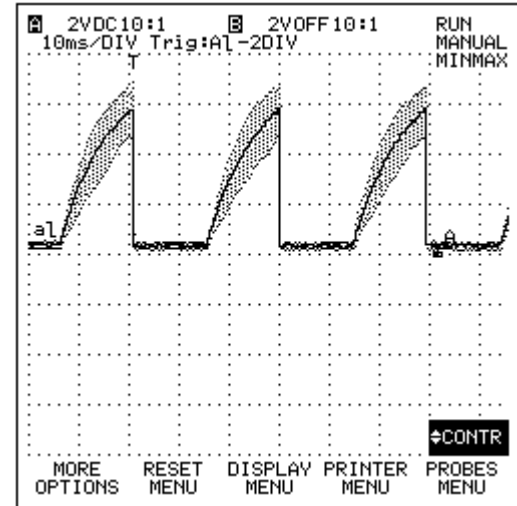

USING THE SCOPE RECORD AND MIN MAX ENVELOPE FUNCTIONS OF THE FLUKE 96B, 99B, or 105B

In SCOPE mode, press  to access the waveform recording functions (see Figure 5.16). You can use these functions to examine waveform changes over time.

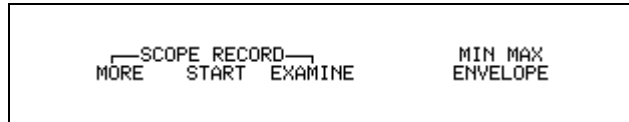

Figure 5-16. Recording Menu

The recording functions are as follows:

SCOPE RECORD

This is a fast electronic 'chart recorder' kind of function with 30k of memory. The large memory allows you to record startup events. The recorder stores 125 successive screens with single channel use, or 62.5 screens with dual channel use, within the time base range from 20 ms/DIV to 60 s/DIV.

This gives you a recording time from 24 s to 20 hours with single channel use, and from 12 s to 10 hours with dual channel use.









You can use cursors and zoom functions to examine waveform details.

MIN-MAX ENVELOPE

This function displays changes in the shape of a live waveform as a grey area around the actual trace. It keeps track of minimum and maximum values that occur over time. This can be used for waveforms A and B and A±B.

Using the ScopeRecord™ function

Before you start the ScopeRecord, make the following preparations:

- Determine whether you need a single ScopeRecord that stops when the record memory is full (SINGLE SWEEP), or a continuous ScopeRecord that stops only by pressing . To make this selection, do the following:
 - From the Min Max Record menu, press  (MORE) to open the menu.
 - Use   to highlight TRACE REPEAT; then press  to select.
 - Highlight the desired option; then press  to select.
- Use   to set the appropriate range for the expected signal. During ScopeRecord, the test tool maintains the present range.
- Use  to set the best time base in the range from 20 ms/DIV to 60 s/DIV. During ScopeRecord the test tool maintains the present time base.

Do the following to start a ScopeRecord:

- From the Min Max Record menu press  (START).
- If there is still data in memory from the previous recording, a message appears asking you to confirm that you want to start recording.

NOTE

Starting a recording overwrites data stored from the previous recording.

Press  (YES) to start the ScopeRecord.

Press  (NO) to cancel the ScopeRecord function.

- To stop ScopeRecord, press . Use the menu on the bottom display to examine the results, as described in the next section starting with step 2.

Examining the ScopeRecord™

To examine a ScopeRecord, do the following:

1. From the Min Max Record menu press (EXAMINE). See Figure 5-16.

The following menu appears:

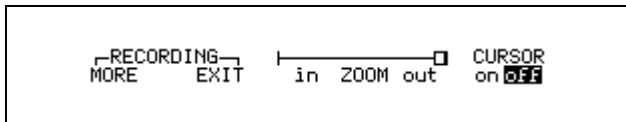

Figure 5-17. Examine menu

2. Use to scroll horizontally through the ScopeRecord. The box above the and keys (zoom box) moves in the corresponding direction to indicate the ScopeRecord location currently displayed.

3. Use (ZOOM in) and (ZOOM out) to increase and decrease the time resolution. increases the time resolution. The zoom box above and becomes smaller to indicate that a smaller, but more detailed part of the ScopeRecord is displayed. decreases the time resolution. The zoom box becomes larger to indicate that a larger, but less detailed part of the ScopeRecord is displayed.
4. To measure the waveform with cursors, press to set CURSORS on. To change cursor settings, press (MORE) to open the setup menu. Refer to Chapter 6 for additional information about the use of cursors.

Using the Min Max Envelope Function

To start this function, do the following:

1. From the Min Max Record menu press (MIN MAX ENVELOPE).

NOTE

Any change in attenuation or time base will start a new Min Max envelope recording.

2. To turn off Min Max envelope recording, do one of the following:

- Press .
- Press .

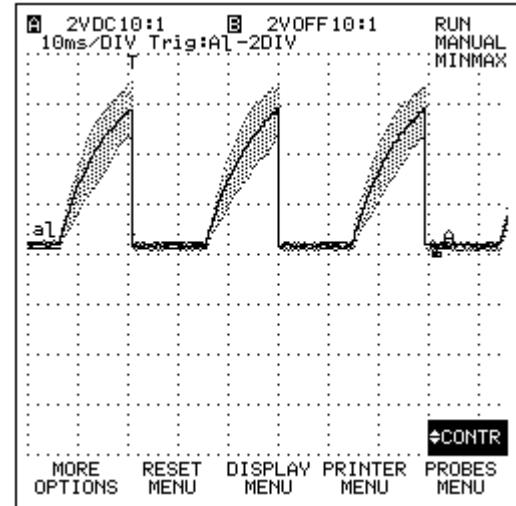

MAKING COMBINATIONS WITH INPUT A AND INPUT B

Press **F4** on INPUT B to select A+B to show INPUTS A and B added together or to select A-B to show INPUT B subtracted from INPUT A.

You can also choose A+B and A-B from the MORE INPUT A or MORE INPUT B window. Highlight COMBINE A & B, and press **F5** to open the list box. You can also select **A versus B** to provide a plot with INPUT A on the vertical axis and INPUT B on the horizontal axis. Press **F5** to activate your selection.

DISPLAYING MULTIPLE WAVEFORMS

By displaying a combination of live and recalled waveforms, the test tool can display a maximum of four waveforms simultaneously. For example, INPUTS A, B, A+B, and waveforms recalled from memory could be displayed. You can display any combination of four waveforms.

If you attempt to display a fifth waveform, a message on the display lets you know that you exceeded the maximum number of four waveforms.

NOTE

The A versus B display is not counted in the four-trace maximum.

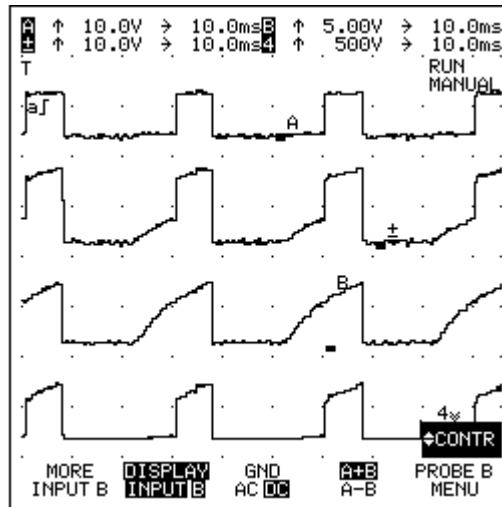



ADAPTING THE DISPLAY

You can adapt the display to your preference as follows:

1. Press .



2. Press  to open the Display Menu window.

Selecting a Dot Size

3. Use   to highlight DOT SIZE and press  to open the list box.

4. Choose a dotsize: SMALL, MEDIUM, or LARGE and press  to select. This selects the trace to be single, double, or triple width.

Selecting a Display Grid

5. Use   to highlight SCOPE GRID and press  to open the list box.

6. Use   to choose between FULL, QUADRANT, or BORDER. Press  to select any of the three.

BORDER provides time and amplitude division marks around the display.

QUADRANT adds horizontal and vertical division points as added reference points to the border display.

FULL adds a crosshatch pattern based on the horizontal time and vertical amplitude divisions on the display.

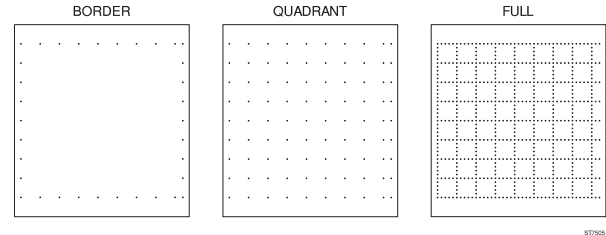





Figure 5-18. Grid Selection

Adjusting the Trace Quality

7. Use  to highlight PERSISTENCE, and press  to open the list box.

Persistence improves the trace quality when you measure on complex waveforms. Choose one of the five persistence states: **short**, **normal**, **medium**, **high**, or **infinite** to obtain the best image on the display. Press  to select. Initially the ScopeMeter test tool is set to normal persistence.

NOTE

Contrast and Persistence work interactively. So when you readjust persistence, it may be necessary to choose another contrast again.

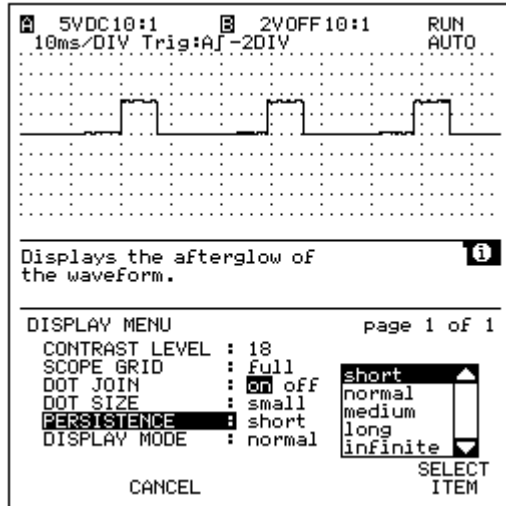

In the DISPLAY window you can also choose the DOT JOIN function, which either shows the individual measurement samples or joins them together to give a continuous trace.

DISPLAY MODE allows you to select normal or reverse video.

- Press **F1** (CLOSE) to remove the window. The test tool displays the USER OPTIONS menu again.

Chapter 6

Using Additional Capabilities

MAKING MEASUREMENTS USING THE CURSORS	6-2
Using the Markers	6-3
Adding a Cursor Main Reading	6-4
DELETING MEMORIES	6-6
SAVING TO MEMORY	6-7
Saving a Screen	6-7
Saving Acquired Waveforms	6-7
Saving a Setup	6-7
Copying Waveforms or Settings	6-8
RECALLING FROM MEMORY	6-8
Recalling a Screen	6-8
Recalling a Waveform	6-9
Recalling a Setup Configuration	6-10
USING WAVEFORM MATH FUNCTIONS	6-11
Scaling the Display	6-11
Choosing a Math Operation	6-11
USING A PRINTER	6-14
Connecting to a Printer	6-14
Setting Print Parameters	6-14
Selecting Printer Types	6-14
Selecting Print Options	6-14
Printing Grey in White or Black	6-16
Sending to a Printer	6-16
USING THE WAVEFORM GENERATOR	6-17
TESTING COMPONENTS	6-17
SETTING THE DATE AND TIME	6-19
Setting the Time	6-19
Setting the Date	6-20
CHANGING THE RESET CONFIGURATIONS	6-20
ALTERING THE CONTINUOUS AUTO SET CONFIGURATION	6-22
Using Manual Override	6-22
Changing Continuous Auto Set Options	6-22

MAKING MEASUREMENTS USING THE CURSORS 92B

The Cursors allow you to make precise digital measurements of waveform activity between measurement areas. This can be done on live waveforms and on saved waveforms.

- From Scope mode, press **SUB MENU** **F5** to turn on (and off) the cursor readings.

Active cursors appear on the display as two vertical and two horizontal lines.

The intersection of vertical and horizontal lines of the left cursor marks a point on the waveform. The intersection of vertical and horizontal lines of the right cursor marks another point on the waveform. The measurement takes place between these two points.

Use **LEFT CURSOR** and **RIGHT CURSOR** to move the left and right cursors which designates the area for the cursor measurement.

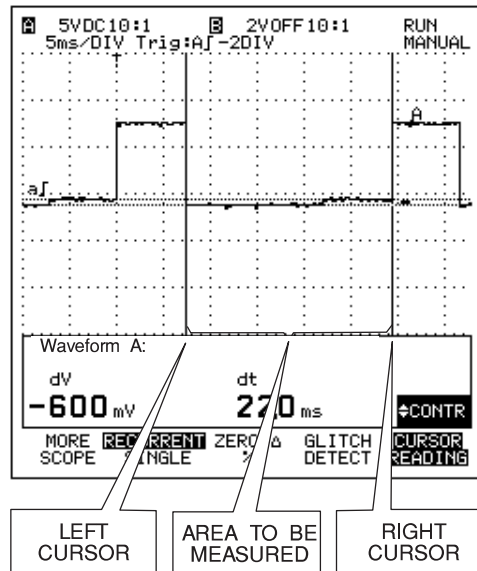

NOTE

You can also find many cursor measurements when using the **MEASURE MENU** key. These measurements are explained in Chapter 3.



ST7507

When the cursor readings are turned on, you can choose one or more measurements as follows:

1. From Scope mode, press   to open to the More Scope window.
2. From the second screen page of the More Scope window, highlight ADD MAIN READING. Press  to open the list box. The ADD MAIN READING list box allows you to choose which cursor measurement reading to display. A list of possible measurements is shown in Figure 6-1.

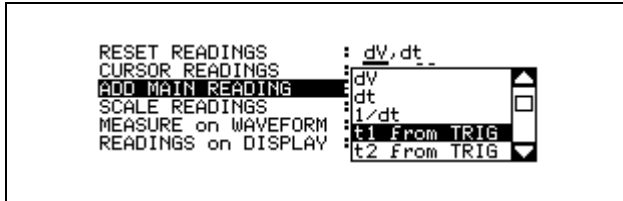





Figure 6-1. Cursor Measurements Window

3. Choose the type of Scaling Reading: off, ZERO Δ , or %
 - off displays the measurement results in normal values.
 - ZERO Δ displays a change to the reference value.
 - % displays a change to the reference value as a percentage.

4. Choose the waveform source with Measure on Waveform. The source selection is determined by active display traces. The traces can be obtained from the active display (A, B, A \pm B) or from waveform memory.
5. Choose the number of Readings; the test tool can display up to five cursor readings at the same time. When you choose another main readings, all readings will shift down one, and your last chosen measurement is placed on top. Notice that the bottom reading is then removed from the display.

Using the Markers

Use the marker to identify the point on the waveform that a measurement has occurred or is expected to occur. The marker appears on the waveform as an "X".

6. From the third screen page of the More Scope window, press  to open the Markers list box. A list box of markers in use is shown in Figure 6-2. Use  or  to choose the marker. Press  to select.

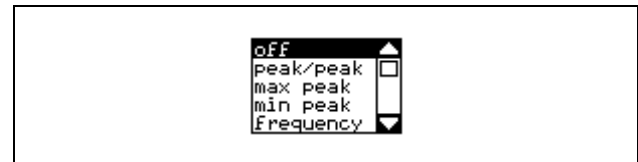
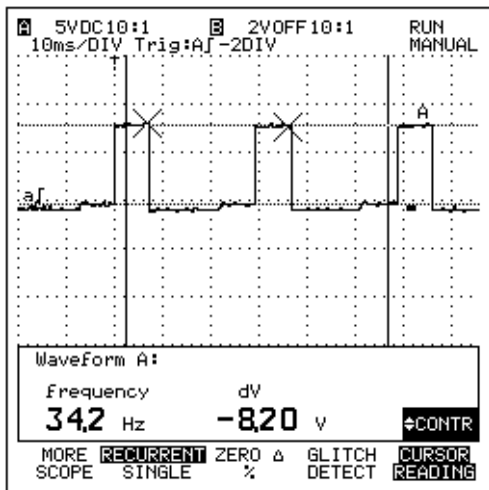

Figure 6-2. Markers List Box





In this example, the markers are defining sample points for measuring frequency.

NOTE

Markers may be easier to see when you press **HOLD RUN** and freeze the waveform.

7. Press **F1** to close the window.

Adding a Cursor Main Reading

From the ADD MAIN READING list box, use  or  to highlight the reading to display, then press **F5** to select. Repeat this for more readings.

In making cursor measurement calculations, the ScopeMeter test tool uses waveform activity between the cursors.

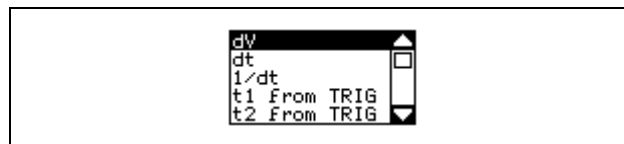

Figure 6-3. Cursor Main Readings List Box

The measurement results are displayed in the bottom display area. A maximum of five measuring functions can be turned on at the same time.

- **dV** (for delta volts) Measures the voltage difference between the cursors.
- **dt** (for delta time) Measures the time difference between the cursors.
- **1/dt** (for relative frequency) Shows the reciprocal value of dt.
- **t1 from TRIG** Measures the time difference between the trigger occurrence and the left cursor.

- **t2 from TRIG** Measures the time difference between the trigger occurrence and the right cursor.
- **V1** Measures the voltage amplitude where the left cursor crosses the waveform.
- **V2** Measures the voltage amplitude where the right cursor crosses the waveform.
- **Vrms** Measures the Root Mean Square (rms) voltage between the cursors.
- **V DC (mean)** Measures the MEAN (average of readings) value of waveform between the cursors.
- **Vpeak/peak** Measures the PEAK to PEAK value of the waveform between the cursors.
- **Vmax peak** Measures the maximum peak value of the waveform between the cursors.
- **Vmin peak** Measures the minimum peak value of the waveform between the cursors.
- **frequency** Measures the frequency of the waveform between the cursors. At least $1\frac{1}{2}$ cycles of this waveform must occur between the cursors. You can scroll a waveform through the cursors by pressing \leftarrow MOVE \rightarrow . Read the frequency change in the bottom display.

- **rise time** Measures the rise time between 10% and 90% points of the waveform. The 0% and 100% points are determined by the intersection of the waveform and the cursors. Set the rising slope to at least four time divisions for a precise measurement.

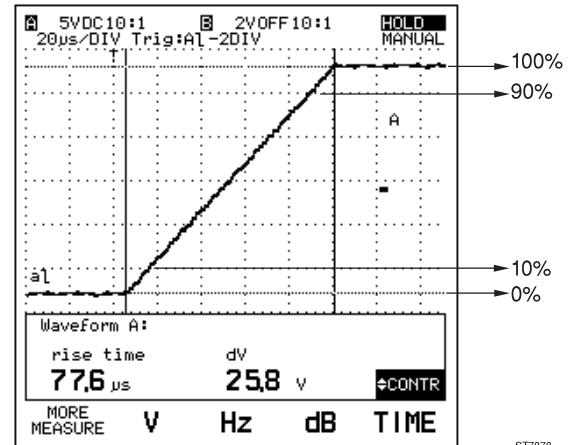

ST7878

- **phase** Measures the phase shift between two waveforms. You can select upto three waveforms for phase measurements to a reference waveform as selected with Measure on Waveform.

DELETING MEMORIES ~~92B~~

Open the Delete Menu at any time by pressing and .

```
DELETE ALL Screen Memory contents
DELETE ALL Waveform Memory contents
DELETE ALL Setup Memory contents
DELETE ALL Memory contents
```

Figure 6-4. Delete Memory List Box

You can now delete all memories or selected memories (Screen memories, Waveform memories, or Setup memories). A message appears prompting you to confirm that you want to delete all memory.

CAUTION

A Master Reset destroys all memory contents and leaves initial setup with its default settings. Refer to "Master Reset configuration" further on in this chapter for a complete discussion of Initial Setup.

You can also delete a single memory location. From the More Save window, first choose the type of memory (DELETE what?) you want to delete: Screen, Waveform, or Setup memory. Press (SELECT ITEM) to open a list box and choose the memory location you want to delete. Use or to highlight the memory number. Press to delete the selected memory location.

SAVING TO MEMORY 92B

You can save screens, waveforms, and setups to memory, copy them between memories, and recall them from memory. Ten nonvolatile Screen memories, 20 nonvolatile Waveform memories, and 40 nonvolatile Setup memories are available. (For FLUKE 96B you can save five nonvolatile Screen memories, 10 nonvolatile Waveform memories, and 20 nonvolatile Setup memories).

- Press to open the Save to Memory menu.

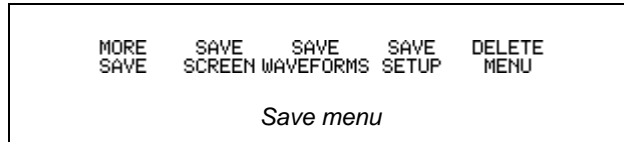

Saving a Screen

Use this function to save the current active display image for future reference. You can save a maximum of 10 screens (For FLUKE 96B you can save a maximum of five screens).

- Press (SAVE SCREEN) to save the current screen in memory (memory #).

The test tool automatically uses the next available memory location. The display continues to show the actual input waveform.

NOTE

When Medium, Long, or Infinite persistence has been chosen, you will only save the actual waveform information.

Saving Acquired Waveforms

Use this function to save acquired waveforms on INPUT A, INPUT B, and A±B in Scope mode, needed for future measurements. You can save a maximum of 20 waveforms (For FLUKE 96B you can save a maximum of 10 waveforms).

- Press (SAVE WAVEFORM).

The test tool starts automatically with the next available memory locations.

Saving a Setup

Use this function to save your keystroke sequences. Once the test tool is set up to make the required measurement, you can save this configuration as one of a maximum of 40 setups (For FLUKE 96B you can save a maximum of 20 setups). A setup is simply the current operating configuration of your ScopeMeter test tool.

- Press (SAVE SETUP).

The test tool starts automatically with the next available memory.

Copying Waveforms or Settings

To copy a waveform or setting from one memory to another, press **F1** to open the More Save window.

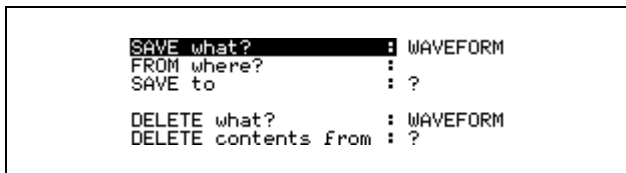

Figure 6-5. More Save Window

First choose what you want to copy, a waveform or a setting. Then determine from which memory you want to copy. On pressing **F5** (SELECT ITEM), you must choose the memory to which you want to copy. The test tool starts automatically with the next available memory.

Use this function to organize the sequence of your waveforms or settings. This can be useful in semi-automatic measurements.

RECALLING FROM MEMORY ~~92B~~

You can review screens and recall waveforms and setups from memory at any time.

- Press **RECALL** to open the Recall from Memory menu.

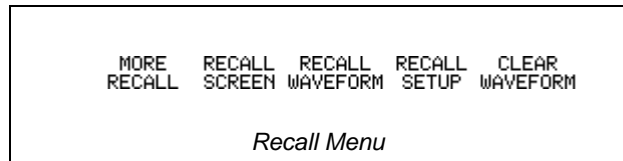

CAUTION

A Master Reset destroys all memory contents and leaves the initial setup with its default settings. Refer to "Master Reset configuration" further on in this chapter for a complete discussion of Initial Setup.

Recalling a Screen

You can display already saved screens with related setups. This is presented as a picture that can no longer be changed. Use this when you want to view a measurement later.

1. Press **F2** (RECALL SCREEN) to view a saved screen from screen memory (memory #).
At the same time the Recall Screen function key menu is activated.

- Use (PREVIOUS SCREEN) or (NEXT SCREEN) to step through the saved screens.
- Press to replace the actual setup with the recalled setup that belongs to the saved screen.

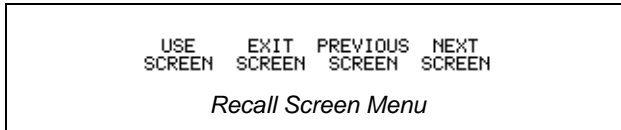





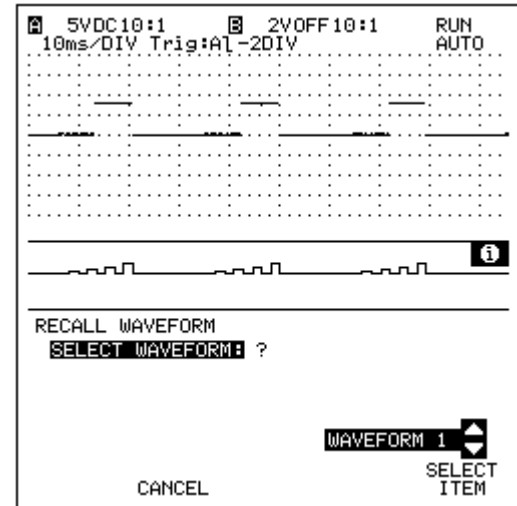

Recalling a Waveform

- Press (RECALL WAVEFORM) to recall a saved waveform from waveform memory. A list of all used waveform memories now appears.
- Use and to highlight the required waveform. The View Area displays the saved waveform in compressed form.
- Press to recall the selected waveform. A displayed memory waveform is indicated with the waveform memory number.





You can display a maximum of four waveforms at a time. If you attempt to display a fifth waveform, a message lets you know you have exceeded the maximum number allowed and suggests that you remove the oldest recalled waveform.



To reposition any of the recalled waveforms on the display, first select the appropriate waveform separately by pressing , highlight "move #" in the list box with  and , and press  to select. **MOVE** appears in the right bottom of the display. Now use  and  to reposition the waveform.

Press  (CLEAR WAVEFORM) to remove all recalled waveforms from the display. The live waveforms (A, B, and A±B) remain displayed, and the present setup configuration will not change.

Recalling a Setup Configuration

- Press  (RECALL SETUP) to recall a saved setup configuration from setup memory. A list of all used setup memories now appears.
- Use  or  to highlight the required setup.
- Press  to recall the selected setup, that replaces the present setup configuration.

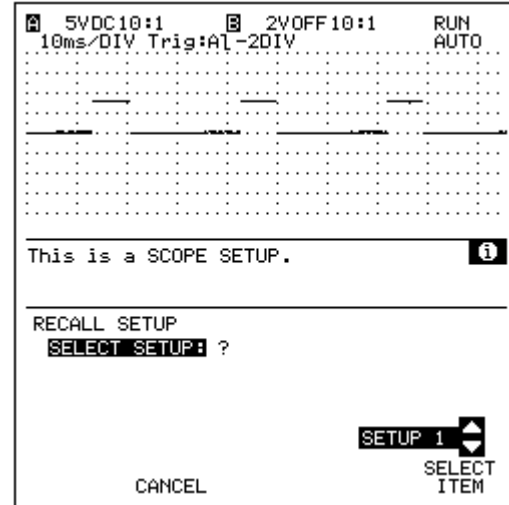

USING WAVEFORM MATH FUNCTIONS







92B 96B

You can perform several math functions on the various waveforms or memories.

- **ADD, SUBTRACT, and MULTIPLY** require two operands (SOURCE 1 and SOURCE 2). The operands can be selected from acquisition memories or waveform memories.
- **INVERT, INTEGRATE, and FILTER** require one operand (SOURCE 1) from acquisition memories or waveform memories.
- All operations require a **DESTINATION** waveform memory selection.

NOTE

Leaving the Math function active will cause a continuous update of the destination memory if the source(s) are active waveform(s).

1. Press  to open the Special Functions menu.
2. Press  to open the MATH menu.
3. Start or stop the math function by turning the MATH FUNCTION on or off.
4. The MATH OPERATION list box lists all math operations available. Choose one and press  to select.
5. Use   to highlight the source(s) and destination items. Press  to open the list boxes. Now choose the source(s) and destination. Press  to select.

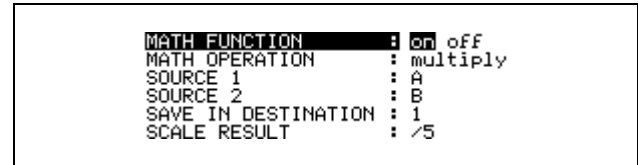







Figure 6-6. Math Window for Multiply

Scaling the Display

The Scale factor allows you to adjust the display to accommodate the math result. Use  or  to highlight SCALE RESULT, and press  to open the list box. You can now use  and  to highlight: off, /5, /25, or /125, and press  to select.

Choosing a Math Operation

You can choose from the following six math operations:

Add Adds two waveforms (each sourced from an active input or a memory location) and stores the result in a waveform memory. For example, waveforms from INPUT A (SOURCE 1) and Waveform 1 (SOURCE 2) can be added, resulting in a waveform stored in Waveform 4 memory (DESTINATION).

Subtract Subtracts the SOURCE 2 waveform from the SOURCE 1 waveform and stores the result in the next free waveform memory. As with ADD, active inputs or memory locations can be used in any combination for the sources.

Multiply Multiplies two waveforms (each sourced from an active input or a memory location) and stores the result in the next free waveform memory. For example, power can be calculated with MULTIPLY if SOURCE1 represents the voltage drop across a device and SOURCE 2 represents current through that device. In the following Figure, waveforms from Waveform 4 memory (upper) and INPUT A (middle) are multiplied, resulting in the waveform stored in Waveform 5 memory (lower).

Invert INVERT allows you to reverse the polarity on an active input or memory waveform and store the new waveform in another memory location.

Integrate This function calculates and displays the area of the selected waveform. Integrate allows you to totalize the waveform over a period of time, showing the real power dissipation when the waveform changes levels.

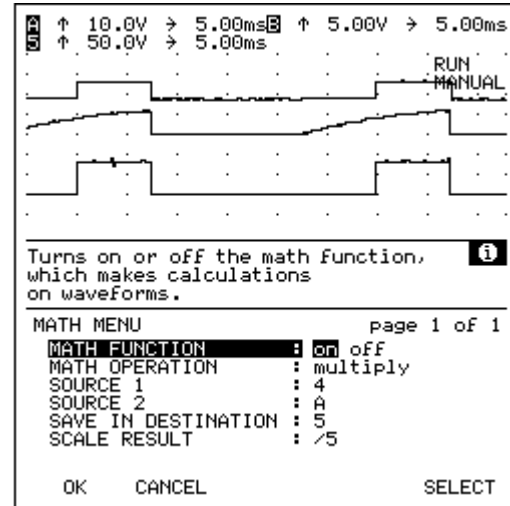

Filter Any waveform (active input or memory) can be filtered, with the resulting waveform stored in a new memory location. Noise suppression or simply waveform smoothing is thereby possible. Filtering is especially useful with single-shot waveforms, where averaging of multiple waveform samples is not otherwise available. In the following figure, the upper waveform represents the INPUT A waveform as measured, and the lower waveform represents the filtered version recalled from Waveform 4 memory.

NOTE

In FILTER function, the -3 dB frequency is $0.8/\text{time-per-division}$.

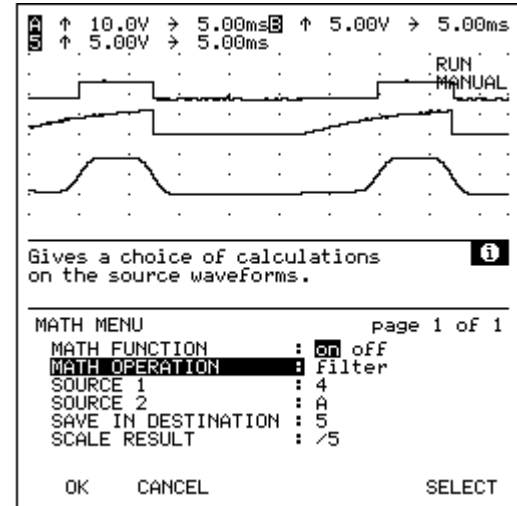

USING A PRINTER

Connecting to a Printer

Use the Optically Isolated RS-232 Adapter/Cable (PM9080/001) to connect a printer to the OPTICAL INTERFACE connection of the ScopeMeter test tool. See Figure 6-7.

CAUTION

Ensure that the printer is turned off during installation. This prevents damage to the printer.

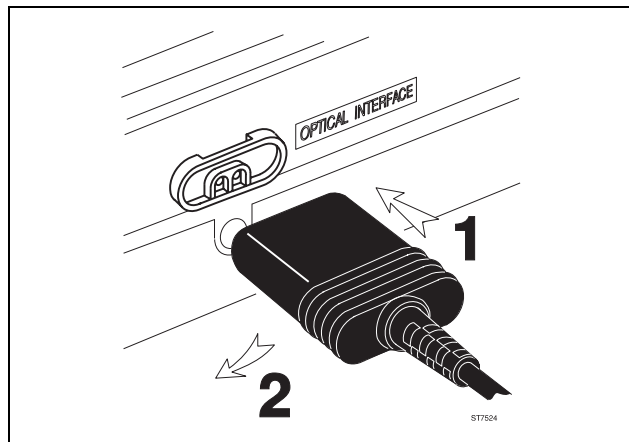



Figure 6-7. PM9080/001 Hookup

NOTE

The following instructions relate to actions you must take at the test tool end of this operation.

Setting Print Parameters

Press  and then  to open the Printer window. You can now choose the printer settings and type of information to print.

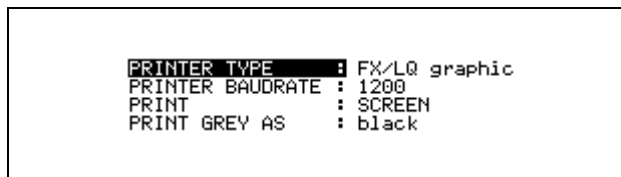





Figure 6-8. Printer Window

Tip: Use   to highlight PRINTER BAUDRATE and press  to read more about printer settings.

Selecting Printer Types

The test tool can print directly to an FX/LQ (Epson), deskjet, or laserjet printer at 1200 or 9600 baud. From the list box, make these printer type selections.

Selecting Print Options

You can choose from the following print options: Screen, Readings, or Waveforms.

WAVEFORMS Print the selected waveform. The waveform is printed in a numerical format that represents sample data points (Scope mode only). You can calculate the real voltage of each data point by subtracting the Y-pos from the data point value (3-0=3, etc), then multiplying this with the 200 mV/dot parameter ($3 * 200 \text{ mV} = 600 \text{ mV}$). The time distance between two dots is $20.0 \mu\text{s}$ here.

Printing Grey in White or Black

Print the grey persistence of the display as white or as black on paper.

Sending to a Printer

Press  to start printing via the OPTICAL INTERFACE port. The settings you made in the User Options menu will be used.

```

ScopeMeter 105B Series II
WAVEFORM Channel A 200mV/dot 800us/dot Y-pos 0dot
 3 -128 -78 -128 -128 17 21 23 25 25 -96 -96 -96 -77
-96 -83 -83 -72 -77 -96 -96 -83 -72 -77
-96 -96 -83 -73 -77 -96 -96 -83 -73 -73 -96 -96 -83 -71 -74
-96 -96 -83 -71 -74 -96 -96 -83 -72 -77
-96 -96 -83 -73 -78 -96 -96 -83 -73 -73 -128 -83 -79 -78 -72
-96 -96 -83 -72 -77 -96 -96 -83 -73 -71
-96 -96 -83 -73 -72 -96 -96 -83 -73 -78 -115 -118 -128 -28 -27
-27 -26 -26 -24 -23 -20 -17 -14 -11 -7

-4 0 3 6 9 12 14 18 21 23 25 25 26 27 28
28 25 25 23 22 19 17 12 11 8
 5 1 -2 -7 -10 -11 -15 -17 -20 -23 -24 -26 -26 -28 -27
-26 -27 -26 -24 -23 -22 -18 -17 -14 -11
-8 -5 0 3 5 9 12 15 18 21 23 24 26 27 28
27 27 26 25 23 22 19 17 13 10
 8 4 1 -1 -6 -9 -12 -14 -18 -20 -22 -24 -25 -27 -27
-28 -27 -27 -26 -25 -24 -22 -20 -18 -14

-11 -8 -5 0 3 6 8 12 14 18 21 22 24 26 27
27 27 28 27 25 23 22 19 17 15
11 8 5 1 -3 -5 -10 -13 -14 -18 -20 -23 -25 -25 -27
-27 -28 -27 -27 -26 -25 -24 -22 -20 -17
-13 -11 -8 -3 0 3 6 10 13 15 18 20 22 24 26
27 27 27 28 27 25 23 22 20 17
14 12 9 5 1 -1 -6 -7 -12 15 -17 -20 -22 -24 -26
-26 -28 -28 -27 -28 -25 -24 -23 -22 -20

-17 -15 -10 -8 -3 -1 3 5 8 12 15 19 20 22 23
26 28 27 26 27 27 26 24 22 20
17 13 11 8 5 2 -3 -5 -9 -13 -15 -17 -20 -23 -24
-26 -26 -27 -28 -27 -28 -27 -24 -24 -21
-20 -17 -14 -11 -9 -4 0 2 5 9 12 14 17 20 24
24 25 27 27 27 27 26 23 22
20 16 15 12 9 5 2 -3 -5 -9 -12 -15 -18 -20 -23
-24 -25 -27 -27 -28 -27 -27 -27 -26 -23

-23 -20 -17 -13 -11 -8 -3 -2 2 6 9 13 15 18 20
22 24 27 27 27 27 26 25 23
22 20 17 14 11 8 5 1 -2 -6 -8 -11 -15 -18 -20
-22 -24 -25 -26 -27 -27 -28 -28 -26 -24
-24 -22 -19 -18 -14 -11 -8 -5 -1 3 6 8 11 15 17
20 22 24 26 26 27 27 26 27 26
25 21 19 16 14 11 8 4 2 -1 -4 -9 -12 -15 -17
-20 -22 -24 -25 -27 -27 -27 -28 -27 -27

-25 -24 -23 -20 -17 -14 -12 -8 -5 -1 2 6

```

USING THE WAVEFORM GENERATOR

~~92B~~ ~~96B~~

Press **SPECIAL FUNCT** and then **F2** to open the GENERATE menu. You can now select a waveform output at the red (GENERATOR OUT) and black (COMmon) 4-mm banana jacks.

```

GENERATOR OUTPUT : on off
GENERATOR WAVEFORM : square 1.95 kHz
  
```

Figure 6-9. Generator Menu

1. Select GENERATOR OUTPUT and turn the generator on and off.
2. Choose one of the six waveforms:
 - Square wave: 1.95kHz, 976Hz, or 488Hz (all at 5V p-p)
 - Sine wave: 976 Hz (1V p-p)
 - Slow ramp: Voltage (-2V to +2V, 1 mA maximum)
Current (0 to 3 mA, 2V maximum)

The generator is automatically disabled in the Ω , \rightarrow , **EXT.mV** and **COMPTEST** mode.

The generator output can also be selected as trigger source; when turned on, it replaces the EXT (external) trigger source in the TRIGGER menu.

TESTING COMPONENTS ~~92B~~ ~~96B~~

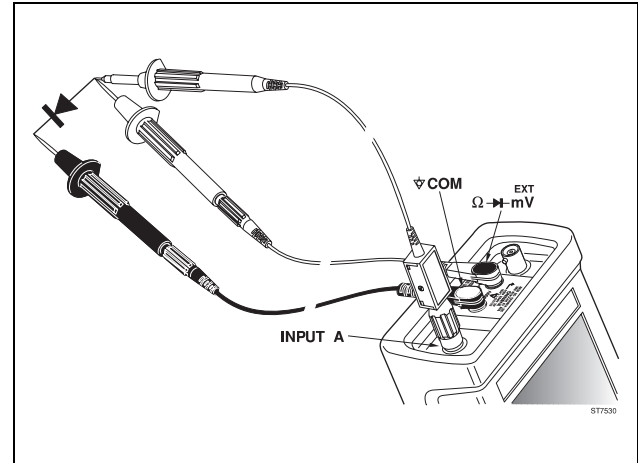

Figure 6-10. Component Test Setup

From the Special Functions menu, press **F4** to use the ScopeMeter test tool as a predefined measuring tool for components. This opens the Component Test menu.

1. Select COMPONENT MENU and turn the component test on and off.

2. Choose the type of TEST WAVEFORM: the test tool outputs a slow voltage sweep (-2V to +2V) or current sweep (0 to +3mA).
3. Choose the TEST PROBE COUPLING: AC or DC coupling.

Connect the component to be tested between the red (GENERATOR OUT) and black (COMmon) 4-mm banana jacks. Measure the component on INPUT A. Its characteristics are shown on the special measure display.

Auto Set cannot be used with the Component measurement mode.

The given display shows a diode test with a slow voltage sweep (-2 to +2V).

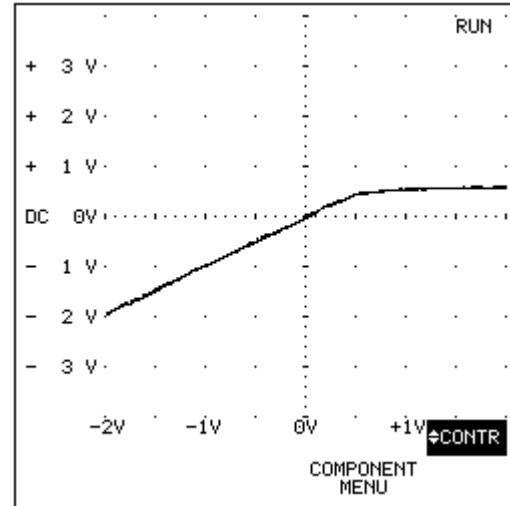

SETTING THE DATE AND TIME

The ScopeMeter test tool has a real time clock that keeps track of date and time. The clock function is useful in combination with Min Max Trendplot™ if you want to know when a particular event occurred.

Setting the Time

You can set the time as follows:

1. From the User Options menu, press (DATE AND TIME) to open the Date and Time menu.
2. Press (SET TIME) to open the time setting menu. Figure 6-11 shows an example of this menu.
3. To change the hours, press (SET HOURS). The time progresses one hour per key press. Hold down to speed up this progression.
4. To change the minutes, press (SET MINUTES). The time progresses one minute per key press. Hold down to speed up this progression.
5. To choose between a 12-hour clock or a 24-hour clock, press (12 / 24 HOUR) .
6. Press (CLOSE) twice to accept the new time.

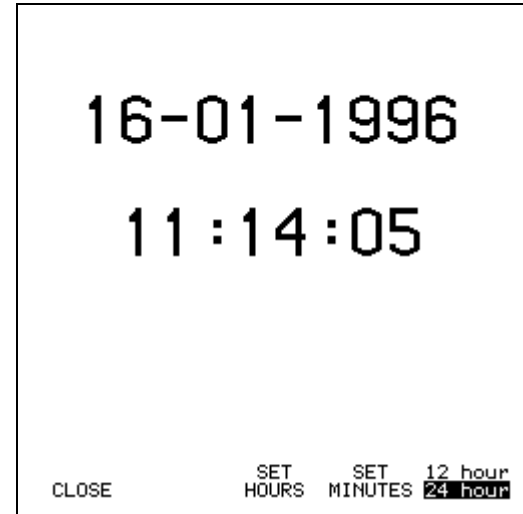

Figure 6-11. Menu for Setting the Time

Setting the Date

You can set the date as follows:

1. From the User Options menu, press (DATE AND TIME) to open the Date and Time menu.
2. Press (SET DATE) to open the date menu.
3. To change the month, press (SET MONTH). The date progresses one month per key press. Hold down to speed up this progression.
4. To change the day, press (SET DAY). The date progresses one day per key press. Hold down to speed up this progression.
5. To change the year, press (SET YEAR). The year progresses one year per key press. Hold down to speed up this progression.
6. To change the day format, press . You can choose between the following:
 - mm-dd-yy (month, day, year) e.g. 02-26-1996
 - dd-mm-yy (day, month, year) e.g. 26-02-1996
7. Press, (CLOSE) twice to accept the new date and date format.

CHANGING THE RESET CONFIGURATIONS

When you turn the test tool on, it begins operation in the last-known configuration, and the main SCOPEMETER function menu appears. Subsequent power-ons maintain configuration changes made with keystrokes or through recall of a setup memory during the previous session. Default settings are used at the first power-on or after a reset. You can reset the test tool at any time. The ScopeMeter test tool can be reset in the following way:

- Master Reset (+). A definition of Master Reset is given below.
- Reset + . Same as Master Reset, but does not clear the memories.

CAUTION

A Master Reset clears all Screen, Waveform, and Setup memories.

The Master Reset includes the following settings:

- Meter Mode
- Three Readings for Meter Mode, and two Readings for Scope Mode
- Autoranging
- Backlight On
- Probe Scaling 10:1
- All Memories Cleared
- Generator Off
- Print Format Screen
- Printer Setup FX/LQ Graph, 1200 Baud

To perform a selective reset, do the following:

1. From the User Options menu, press to open the MORE OPTIONS menu.
2. Press to open the RESET menu (see Figure 6-12).
3. Choose the reset options which include: the default settings for Master Reset, or selectively resetting any of the main modes, e.g., Scope, Meter, Ohm, Diode, or EXT.mV.

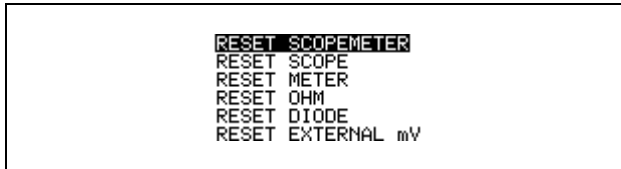

Figure 6-12. Reset Menu Window

4. Press to reset.

Some of the configuration settings can be preset to become active at every power on.

1. From the User Options menu, press (MORE OPTIONS), and open the STARTUP MENU window (see Figure 6-13).

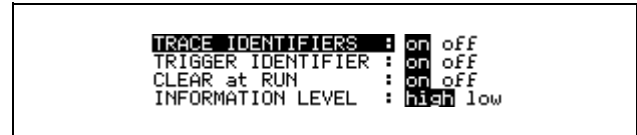



Figure 6-13. Startup Menu Window

2. Specify on or off for each of the following:
 - whether or not to identify the waveform (trace) source (**TRACE IDENTIFIERS**).
 - whether or not to identify the trigger source, slope, level, and delay (**TRIGGER IDENTIFIER**)
 - whether or not to **CLEAR at RUN**. When Clear at Run is set to on, and you perform a single shot, the old waveform is cleared first each time the test tool writes a new waveform.
 - whether or not to select high or low **INFORMATION LEVEL** facility. When the Information Level is set to high, you will get all on-line information available in your ScopeMeter test tool.

Factory defaults place all four of these items on.



3. Press to select the new Default Settings.
4. Press to close the window.



ALTERING THE CONTINUOUS AUTO SET CONFIGURATION

When  is pressed, the instrument assumes the Continuous Auto Set configuration.

There are ways to alter the Continuous Auto Set configuration. These two methods are discussed below.

Using Manual Override





Pressing   disables autoranging for voltage attenuation only. Press  to resume the normal mode of operation for Continuous Auto Set.

Pressing  disables autoranging for the time base setting only. Press  to resume the normal mode of operation for Continuous Auto Set.

Changing any of the trigger settings disables autoranging for voltage, time base, and triggering. Press  to resume the normal mode of operation for Continuous Auto Set.

Changing Continuous Auto Set Options

Change the Continuous Auto set configuration as follows:

1. From the User Options menu, press  (MORE OPTIONS) and use   to highlight AUTO SET. Press  to open the window (see Figure 6-14).

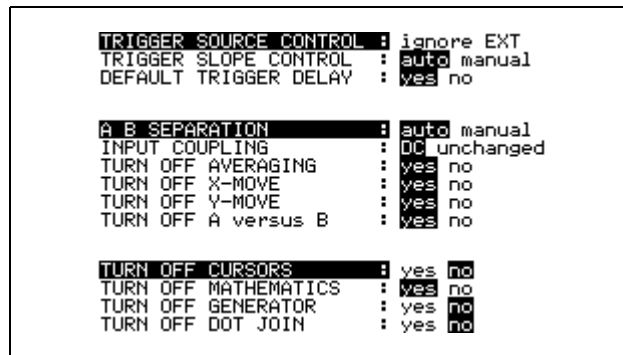

Figure 6-14. Continuous Auto Set Window

The items shown in this window are divided into three pages. Select a page with (PREVIOUS PAGE) or (NEXT PAGE).

2. The first page in the window defines some basic actions taken during Auto Set. Specify whether the Continuous Auto Set will optimize trigger source and trigger slope during measurement. The factory default is "auto". Also specify whether Auto Set will reset trigger delay (default is that any delay set will be turned off).
3. The second page defines the input setup or items that are turned off when the Continuous Auto Set is active.
 - A B SEPARATION** (Default is auto: both waveforms appear, separated by two divisions).
 - A B COUPLING** (Default is DC: both inputs are DC coupled).
 - TURN OFF AVERAGING** (Default is yes: smooth function is turned off).
 - TURN OFF X-MOVE** (Default is yes: waveform in center of the display).
 - TURN OFF Y-MOVE** (Default is yes: waveform in center of the display).
 - TURN OFF A versus B** (Default is yes: A vs B function is turned off).

4. The third page defines functions that are turned off when the Continuous Auto Set is active.

TURN OFF CURSORS (Default is no : Cursors are not turned off).

TURN OFF MATHEMATICS (Default is yes : Mathematical function is turned off).

TURN OFF GENERATOR (Default is no : Generator is not turned off).

TURN OFF DOT JOIN (Default is no : Dot Join remains active).

Chapter 7

Measuring Examples

MEASURING TEMPERATURE	7-2
MEASURING CURRENT	7-4
MEASURING POWER WITH MATH FUNCTION	7-7
MEASURING THREE-PHASE ON A DUAL INPUT ..	7-9

MEASURING PHASE USING THE CURSORS	7-12
MEASURING PULSE RESPONSE OF AN AMPLIFIER	7-14

This chapter examines some typical measurements that can be made with your ScopeMeter test tool. The examples given can be used as an aid in many applications.

MEASURING TEMPERATURE

Temperature is an often measured characteristic. The 80T-150U optional Temperature Probe can be used in conjunction with the test tool to measure the surface temperature, air temperature, and non-corrosive liquid temperature. You can measure fluctuations in temperature over a long period of time when the Min Max recording is activated. Readings on the test tool can be given in Fahrenheit or Celsius.

In this example, the air temperature is measured over 24 hours.

Connect the 80T-150U Temperature probe to the red and black 4-mm banana jacks as shown in Figure 7-1.

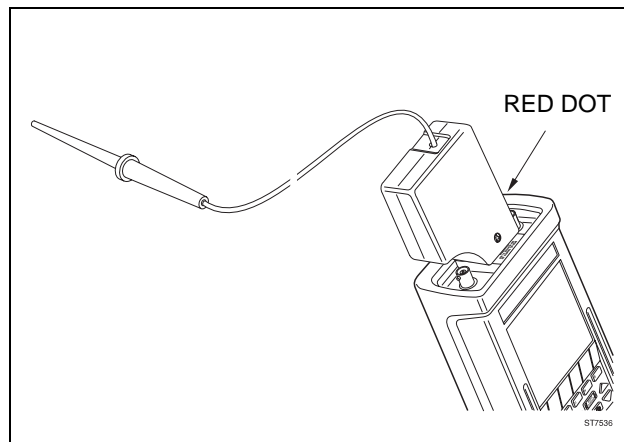

Figure 7-1. Temperature Measurement Setup

- ① + ON OFF
Do a Reset; probe scaling factor is 10:1.
- ② (EXT.mV)
Be sure that the slide switch on the probe is in the OFF position. A reading of more than 65 mV DC indicates that the battery of the probe is good.
- ③ MEASURE MENU
- ④ : °C PROBE
Select degrees Celsius range.

- ⑤ Move the slide switch on the probe to the °C position.
- ⑥ The actual air temperature appears on the display.

- ⑦ MIN MAX RECORD
 The test tool starts continuously recording the air temperature and graphs the minimum, maximum, and average temperatures on the display. After about 24 hours the display appears as shown in Figure 7-2.

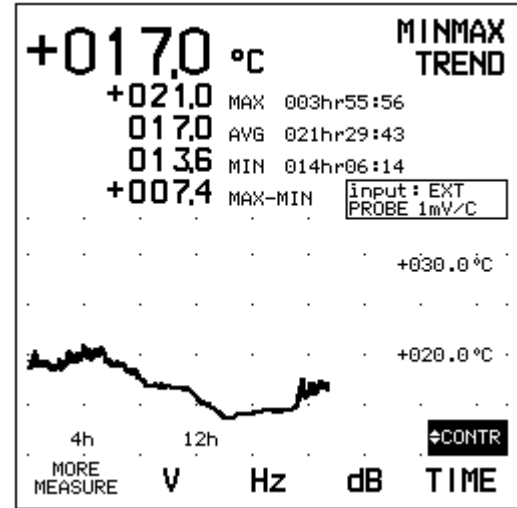

Figure 7-2. Temperature Measurement with Trend Plot

MEASURING CURRENT

The 80i-1000s Current Probe is an optional accessory designed for use with the ScopeMeter test tool to measure current flow in electrical circuits. The reading in the Measure menu can be assigned to current (amps) sensed by the Current Probe. Refer to the instruction sheet provided with the 80i-1000s for complete information about Current Probe operation.



WARNING

TO AVOID ELECTRICAL SHOCK, USE ONLY CURRENT PROBE ACCESSORIES SPECIFICALLY DESIGNED AND APPROVED FOR USE WITH THE SCOPEMETER TEST TOOL. OTHER PROBES MAY EXPOSE THE OPERATOR TO AN ELECTRIC SHOCK HAZARD IF ANY OF THE THREE COMMON INPUT CONNECTIONS ARE CONNECTED TO A POTENTIAL GREATER THAN 30V RMS OR 42V DC.

The following example measures the current flow in an electric motor for 220V line power.

Connect the 80i-1000s Current Probe to the red INPUT A BNC as shown in Figure 7-3.

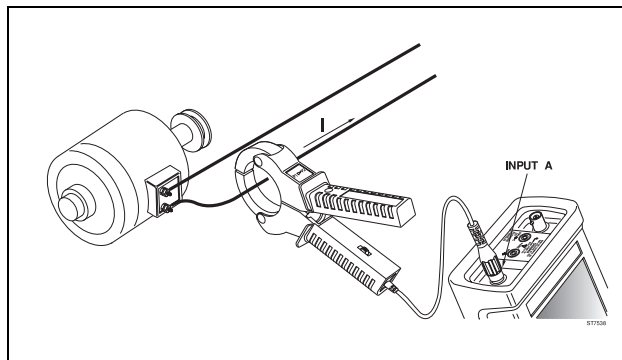

Figure 7-3. Current Measurement Setup

- ① Set current probe range switch to 10 mV/A.
- ② +
Do a Reset; probe scaling factor is 10:1.
- ③ →
- ④
Select page 4 of the More Measure window.
- ⑤ : A AC+DC METER →
- ⑥ : 10 mV/A →
Select Current Probe range.
- ⑦ Clamp the Current Probe jaws around the conductor to be measured.
- ⑧ The actual current appears on the display: 17.43 Arms.

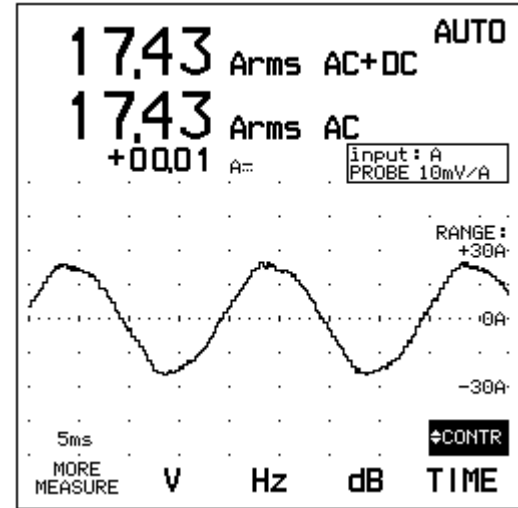

Figure 7-4. Current Measurement in Meter Mode

To see the current as a waveform, set the test tool as follows:

- ① Set Current Probe range switch to 10 mV/A.
- ② +
Do a Reset; probe scaling factor is 10:1.
- ③
Select Scope mode.
- ④
Select Continuous Auto Set.
- ⑤ →
Select the Probe A menu.
- ⑥
Open the Probe on INPUT A box.
- ⑦ :10 mV/A →
Select current range.
- ⑧
Close the window.
- ⑨ The test tool displays the current as a waveform, which can be analyzed using all other functions. The selected range appears on the top display.

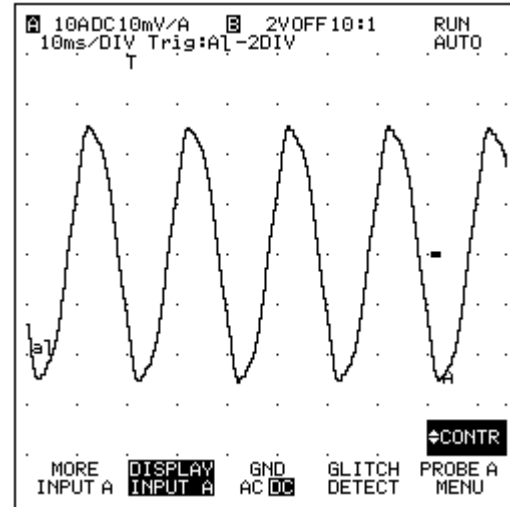

Figure 7-5. Current Measurement in Scope Mode

MEASURING POWER WITH MATH FUNCTION ~~92B~~ ~~96B~~

When used with the optional 80i-1000s Current Probe, the ScopeMeter test tool is able to measure voltage and current at the same time. This may be used to measure average power consumption of an electrical load on a single-phase circuit. This measurement is reliable over a wide range of frequencies, irrespective of the wave shapes of voltage or current.

In this example you make use of the previous measurement setup, measuring current with the 80i-1000s on INPUT A, and will add the voltage measurement using the grey 10:1 probe on INPUT B. Be sure that INPUT A is set to 10 mV/A, and INPUT B is set for a 10:1 probe.

This example shows the connection method and MATH function operation that accomplishes this.

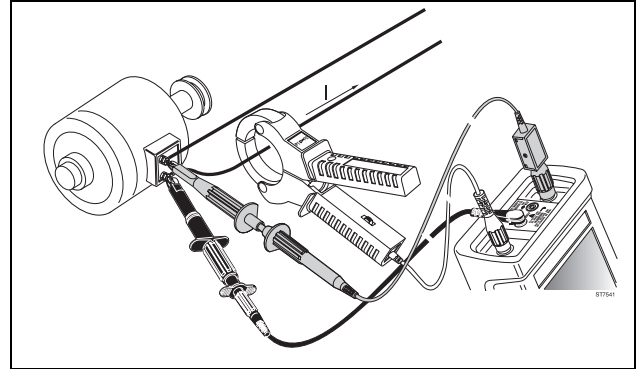

Figure 7-6. Power Measurement Setup

①  Select Continuous Auto Set.

② 

③  Open the Math menu.

```

MATH FUNCTION : on off
MATH OPERATION : multiply
SOURCE 1      : A
SOURCE 2      : B
SAVE IN DESTINATION : 1
SCALE RESULT  : /5
  
```

④     Select each item.
Store the resulting waveform in Destination memory 1.

⑤  Close the window.

In Figure 7-7, INPUT A represents the current measurement, INPUT B the voltage measurement, and Destination memory 1 the product (equals power).

In this example the following scales are used:

INPUT A: 20 A/DIV
 INPUT B: 200 V/DIV
 Memory 1: 4 kW/DIV

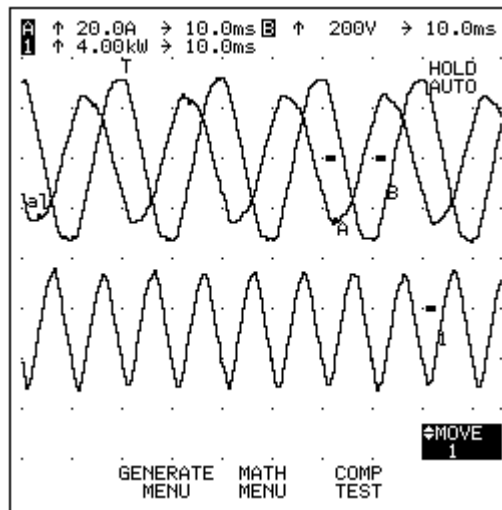





Figure 7-7. Power measurement

Shift the resulting waveform over the display as follows:

⑥ 

⑦   : move 1  

⑧   Move the resulting waveform.

MEASURING THREE-PHASE ON A DUAL INPUT

Dual input measurements can be used for many applications. This example shows how to use these measurements to determine phase rotation of a "Y" connected three-phase system at a load center. Use alligator clips to connect the ScopeMeter test tool to the three-phase system connections.

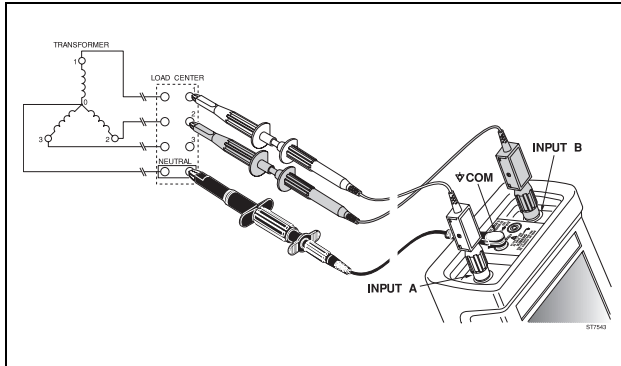

Figure 7-8. Testing a Three-Phase System

WARNING

THE SETUP REQUIRES CONNECTING TEST LEADS TO LIVE COMPONENTS OF A HIGH ENERGY CIRCUIT. TO AVOID ELECTRIC SHOCK AND/OR EQUIPMENT DAMAGE, USE CAUTION WHEN CONNECTING ALLIGATOR CLIPS TO LIVE COMPONENTS.

THE METAL JAWS OF ALLIGATOR CLIPS CAN CREATE A SHORT CIRCUIT BETWEEN CLOSELY SPACED LIVE PARTS. AVOID MAKING CONNECTIONS TO FEEDER CONDUCTORS OR BUS BARS AT ELEVATED POTENTIALS. WHENEVER POSSIBLE, MAKE CONNECTIONS TO THE OUTPUT SIDE OF A CIRCUIT BREAKER WHICH CAN PROVIDE BETTER SHORT CIRCUIT PROTECTION.

MAKE CONNECTIONS TO CIRCUIT BREAKERS BY FIRST TURNING THE CIRCUIT BREAKER OFF. THEN CONNECT THE ALLIGATOR CLIP TO THE BREAKER OUTPUT TERMINAL VIA A SHORT PIECE OF INSULATED WIRE AS SHOWN IN FIGURE 7-9.

Make sure the circuit breaker is turned off. Connect the test tool to two circuit breakers of two different phases and the neutral bus bar as shown in Figure 7-9. Use the alligator clips for the red and grey 10:1 probes and black multimeter test lead.

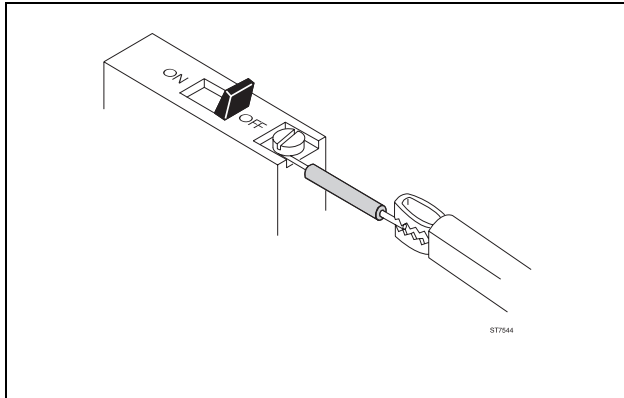





Figure 7-9. Connecting the Wires

- ①  + 
Do a Reset; probe scaling factor is 10:1.
- ② 
Set the test tool to Scope mode.
- ③ 
Select Continuous Auto Set.
- ④ Turn circuit breaker on.
- ⑤ Measure connection 1 and connection 2 (see Figure 7-10.)

The upper display in Figure 7-10 shows that phase 2 (INPUT B) follows phase 1 (INPUT A). The lower display shows that phase 3 follows phase 1.

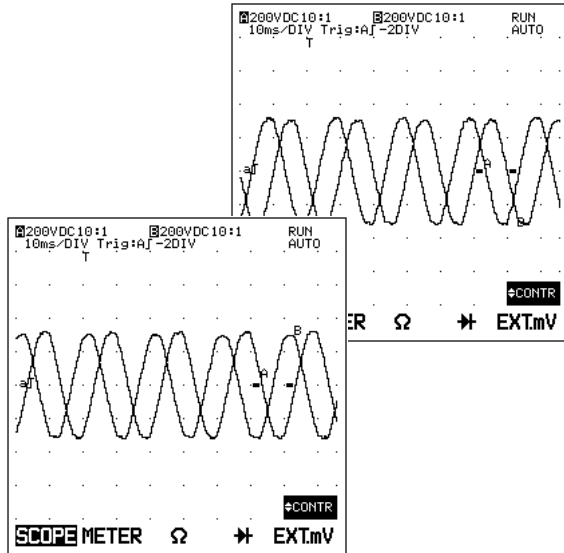



Figure 7-10. Phase Measurements

⑥ MEASURE MENU → F2

⑦   : Vrms AC (METER) → F5

The Volt RMS readout (about 230 Vrms) appears on the display. (see Figure 7-11.)

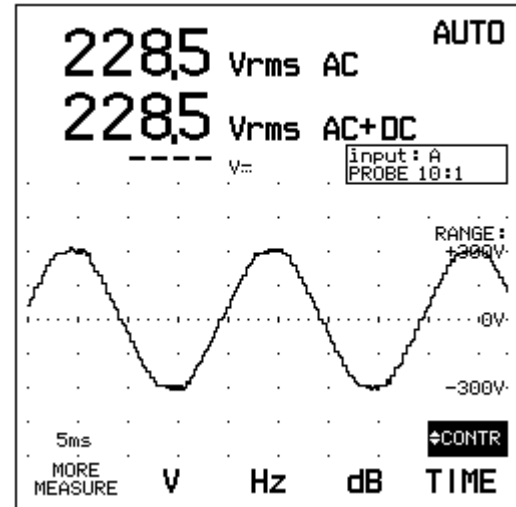



Figure 7-11. AC Volt RMS Measurement

MEASURING PHASE USING THE CURSORS

92B



In this example you will use the cursors to measure the phase difference between the waveforms on INPUT A and B. Use the two waveforms from the dual input three-phase measurement in the previous exercise. Cursors allow you to make accurate digital measurements. It is advised that you first press  to freeze the waveforms to be measured.



① Measure the two sine wave waveforms as explained in the previous example.

②  Return to the main menu.

③  Set the test tool to Scope mode.



④  Freeze the display; **HOLD** appears in the upper right display.

⑤    Activate the Cursor readings.



⑥    Go to page 2 within the More Scope window.

⑦  Choose ADD MAIN READING.

⑧  Open the list box.

⑨  : phase A>B  .

⑩  Close the window.

⑪   Position the two cursors on the waveforms; see Figure 7-12.

The display shows the phase between the waveforms on INPUT A and INPUT B: "phase A>B -120°" (see Figure 7-12).

To identify the point on the waveforms where the measurement has occurred, you can use the markers on page 3 within the More Scope window.

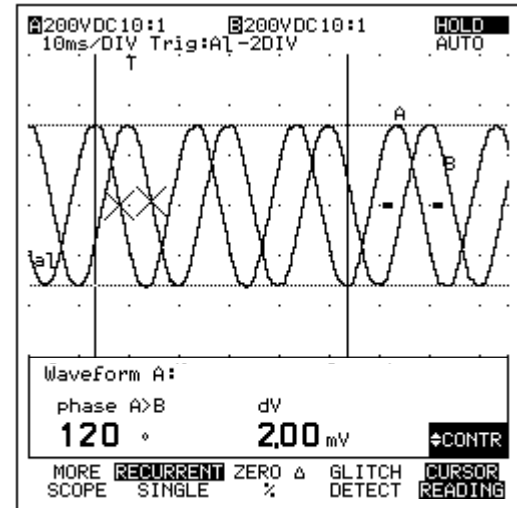

Figure 7-12. Phase Measurement (with Markers)

MEASURING PULSE RESPONSE OF AN AMPLIFIER ~~92B~~

In this example you will use cursors to measure the rise time of a pulse. Rise time is an indication of the bandwidth limitation of an analog amplifier. First you determine the 0% and 100% reference points of the waveform to be measured. These are the intersections of the waveform and the cursors. This manual determination of the reference points enables you to ignore unwanted overshoot, undershoot, or ringing. The test tool instantly measures the rise time between 10% and 90%. For precise measurements, set the slope to at least four time divisions.

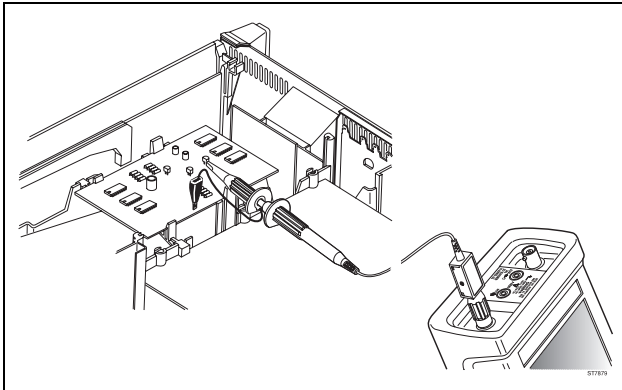















Figure 7-13. Measuring the rise time of a pulse.

- ①  + 
Do a Reset; probe scaling factor is 10:1.
- ② 
Set the test tool to Scope mode.
- ③ 
Select Continuous Auto Set.
- ④ 
Press as many times as necessary until you have a **rising** slope of more than four time divisions.

Make sure that the complete slope is displayed. If necessary you can use the trigger time delay to shift the detail on the display.

- ⑤   
Open the TIME window.
- ⑥  : rise time  
Select the rise time measurement.

Now you are ready to do a precise rise time measurement.

- ⑦  Set the left cursor to the low level of the waveform: see Figure 7-14. This is the 0% reference point.
- ⑧  Set the right cursor to the high level of the waveform: see Figure 7-14. This is the 100% reference point.
- ⑨ The test tool instantly displays the rise time: "156 ns". (See Figure 7-14.)

To identify the points on the slope where the measurement has occurred, you can use the markers on page 3 within the More Scope window.

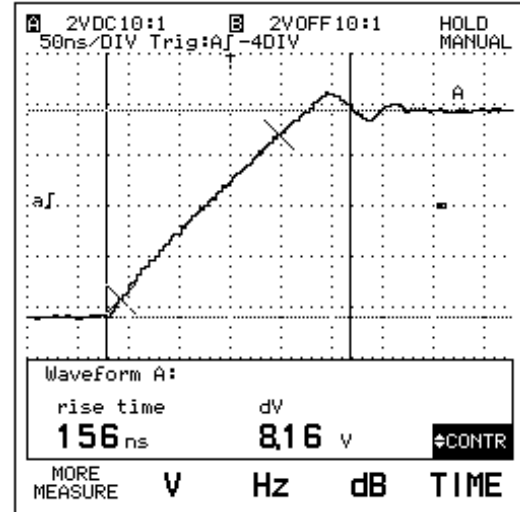

Figure 7-14. Rise Time Measurement (with markers)

Chapter 8

User Maintenance

CLEANING	8-2
KEEPING BATTERIES IN OPTIMAL CONDITION ..	8-2
REPLACING AND DISPOSING OF BATTERIES ...	8-3
REPLACING FUSES	8-5

CALIBRATING THE PROBES	8-5
INPUT A Probe Calibration	8-5
INPUT B Probe Calibration	8-6



WARNING

RISK OF ELECTRIC SHOCK OR FIRE:

USE ONLY INSULATED PROBES, TEST LEADS, AND CONNECTORS SPECIFIED IN THIS MANUAL WHEN MAKING MEASUREMENTS >42V PEAK (30V RMS) ABOVE EARTH GROUND OR ON CIRCUITS >4800 VA.

USE PROBES AND TEST LEADS WITHIN RATINGS AND INSPECT BEFORE USE.

REMOVE UNUSED PROBES AND TEST LEADS.

REMOVE PROBES AND TEST LEADS BEFORE OPENING CASE OR BATTERY COVER.

WHEN THE SCOPEMETER TEST TOOL IS CONNECTED TO ITS POWER ADAPTER/BATTERY CHARGER, TERMINALS MAY BE LIVE, AND THE OPENING OF COVERS OR REMOVAL OF PARTS (EXCEPT THOSE THAT CAN BE ACCESSED BY HAND) IS LIKELY TO EXPOSE LIVE PARTS.

THE TEST TOOL MUST BE DISCONNECTED FROM ALL VOLTAGE SOURCES BEFORE IT IS OPENED FOR ANY ADJUSTMENT, REPLACEMENT, MAINTENANCE, OR REPAIR.

CAPACITORS INSIDE MAY STILL BE CHARGED EVEN IF THE TEST TOOL HAS BEEN DISCONNECTED FROM ALL VOLTAGE SOURCES.

CLEANING

Clean the ScopeMeter test tool with a damp cloth and a mild detergent. Do not use abrasives, solvents, or alcohol.

KEEPING BATTERIES IN OPTIMAL CONDITION





When new, the batteries typically provide 4 hours of use. To keep batteries in optimal condition, do the following:

Always operate the test tool on batteries until a blinking  appears in the top right of the display. This indicates that the battery level is too low and the batteries need to be recharged.

CAUTION

Frequent charging of the batteries when they are not completely empty can cause a "memory effect". This means that the capacity of the NiCad batteries decrease, causing a decrease in the operating time of the test tool.

You can revitalize a battery pack with too low capacity as follows:

1. Reset the ScopeMeter test tool ( + ), and ensure that the test tool is battery operated.
2. Press .
3.  Press .

This disables the battery save feature when no key entry is made for 5 minutes. Wait until the test tool is automatically turned off. When it is turned off, the batteries are completely discharged. Depending on the condition of the batteries, the discharging can last up to 8 hours.

4. When the test tool is turned off, connect the Power Adapter/Battery Charger PM8907 to the test tool and to local line power.
5. Charge for more than 21 hours.
6. Repeat steps 1 through 5 once more.

REPLACING AND DISPOSING OF BATTERIES



TO AVOID ELECTRICAL SHOCK, REMOVE THE TEST LEADS, PROBES, AND BATTERY CHARGER BEFORE REPLACING THE BATTERIES.

1. Disconnect the test leads, probes, and battery charger both at the source and at the ScopeMeter test tool.
2. Separate the test tool from its holster.
3. Locate the battery cover on the bottom rear. Loosen the two screws with a flat-blade screwdriver.
4. Lift the battery cover away from the test tool.
5. Remove the NiCad battery pack (or alkaline batteries, type KR27/50 or R14) from the battery compartment.

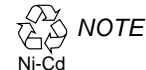

This instrument contains a Nickel-Cadmium battery. Do not dispose of this battery with other solid waste. Used batteries should be disposed of by a qualified recycler or hazardous materials handler. Contact your authorized Fluke Service Center for recycling information.

6. Install a new NiCad battery pack (PM9086) or new alkaline (C Cell) batteries (type KR27/50 or R14) as shown in Figure 8.1.

NOTE

Ensure that the NiCad battery pack charging contact is aligned in the battery compartment as shown in Figure 8.1. Use only the PM9086 NiCad battery pack.

7. Reinstall the battery cover and secure the two screws.

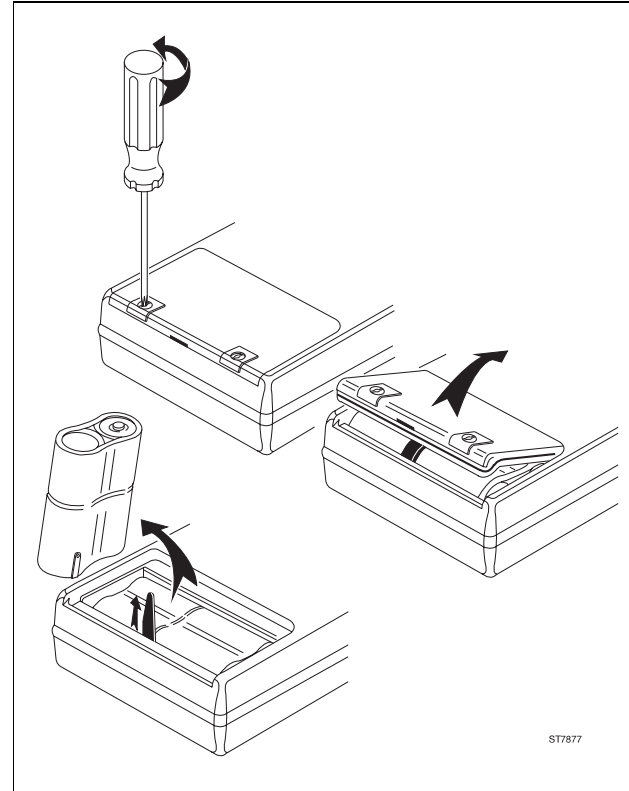

Figure 8-1. Battery Replacement

REPLACING FUSES

Since the test tool uses electronically protected inputs, no fuses are required.

CALIBRATING THE PROBES

The following procedures describe dc calibration and ac adjustment for the 10:1 probe used on INPUT A (red scope probe) and INPUT B (grey scope probe).

NOTE

To meet full user specifications, use the 10:1 probes only with the inputs on which they have been calibrated.

INPUT A Probe Calibration

1. Connect the INPUT A BNC input to the GENERATOR OUT red banana jack. See Figure 8-2. Use the red scope probe and the red 4-mm banana adapter.
2. Turn the ScopeMeter test tool on.
3. Press **USER OPTIONS**.
4. Press **F5** to open the PROBES MENU window.
5. Use **▲** **▼** to highlight PROBE on INPUT A, and press **F5**. This opens the list box.

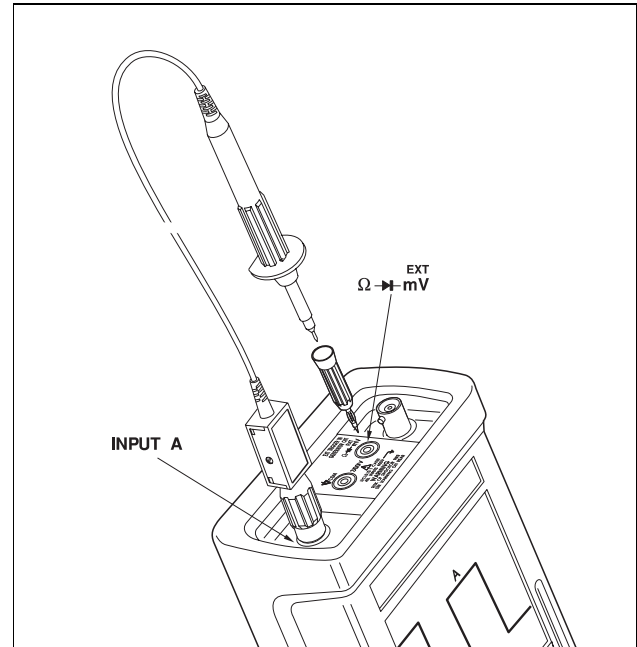







Figure 8-2. INPUT A Probe Calibration Setup

6. Use   to highlight 10:1, and press  to select.
7. Use  to select CALIBRATE PROBE on A, and press  to calibrate.

The test tool outputs a voltage on the GENERATOR OUT banana jack to the connected probe.

8. Adjust the trimmer screw in the probe housing of INPUT A to give an optimum square wave within the equal markers on the display (see Figure 8-3).

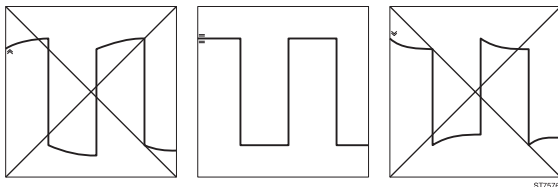



Figure 8-3. Adjusting the Probe

9. Press  to continue.

The test tool automatically calibrates itself to the probe. A message appears on the display indicating that calibration is successfully completed.

10. Press  to close the procedure.

INPUT B Probe Calibration

1. Connect the INPUT B BNC input to the GENERATOR OUT red banana jack. See Figure 8-4. Use the grey scope probe and the grey 4-mm banana adapter.

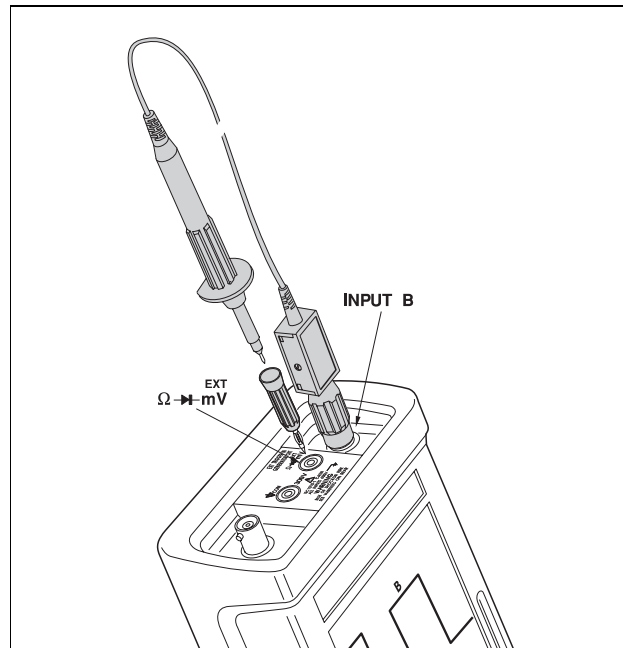

Figure 8-4. INPUT B Probe Calibration Setup

2. Repeat steps 2 through 10 of the INPUT A calibration.

Chapter 9 Appendixes

9A	Specifications	9-3	9D	Warranty and Service Centers	9-21
9B	Parts and Accessories	9-15	9E	Terminology	9-23
9C	PM8907 Information	9-19			

Appendix 9A

Specifications

INTRODUCTION

Performance Characteristics

FLUKE guarantees the properties expressed in numerical values with the stated tolerance. Specified non-tolerance numerical values indicate those that could be nominally expected from the mean of a range of identical ScopeMeter test tools.

For definitions of terms, refer to IEC Publication 351-1.

Safety Characteristics

The ScopeMeter test tool has been designed and tested in accordance with IEC Publication 1010, Safety Requirements for Electrical Equipment for Measurement, Control, and Laboratory Use. This manual contains information and warnings that must be followed by the user to ensure safe operation and to keep the instrument in a safe condition. Use of this equipment in a manner not specified by the manufacturer may impair protection provided by the equipment.

Environmental Data

The environmental data mentioned in this manual are based on the results of the manufacturer's verification procedures.

Single Shot	100 ns to 1 s/div
Dual input alternating	100 ns to 20 μ s/div
Dual input chopped50 μ s to 1 s/div
Roll2 s to 60 s/div
Dual input chopped2 s to 60 s/div
Accuracy	+(0.1% + 1 pixel)
Record Length	256 or 512 samples (10 or 20 division)
ScopeRecord™ (Fluke 99B, 105B)	30k samples from 20 ms/div to 60s/div

Trigger (NORMAL mode)

Sources	A, B, or EXTERNAL
Sensitivity: A or B	<0.8 div to 10 MHz <1.5 div to 60 MHz <4.0 div to 100 MHz
Sensitivity: EXTERNAL	+0.2V or 2.0V (TTL level compatible)
External Input Impedance	1 M Ω //25 pF direct, 10 M Ω //15 pF with 10:1 probe
Delay Time	-20 to +640 div
N-cycle Trigger	Retriggers after 2 to 255 trigger cycles
Delay by events	1 to 1023 events after EXT trigger

TV Trigger (on INPUT A only)

TV Trigger Modes	Lines, Frame, Odd/Even fields, Line Number, 4-Field Sequence
Video Modes	Positive and Negative Video
TV Systems	NTSC, PAL, PAL-M, SECAM, Non-Interlaced

Scan Rates	14 to 21 kHz, 19 to 33 kHz (non-interlaced), 31 to 65 kHz (non-interlaced)
TV Trigger Sensitivity	1.5 division (with a minimum of (on INPUT A) 30 mV) to 21 divisions peak-peak

Cursor Measurements ~~92B~~

Up to five displayed simultaneously. All voltage measurements can be ampere measurements with optional Current Probes.

Single cursor measurements:

V1, V2, t1 from TRIG, t2 from TRIG.

Dual cursor measurements:

Hz, Vrms, VDC (mean), Vpeak/peak, V max peak, V min peak, rise time, phase, dV, dt, and 1/dt.

Measurement readout:

absolute, relative (zero), or % change.

Markers selectable on:

Hz, Vpeak/peak, V max peak, V min peak, rise time, and phase

Waveform Mathematics ~~92B~~ ~~96B~~

Add, Subtract, Multiply, Invert, Filter, or Integrate input waveforms.

Calculate instantaneous or mean (real) electrical watts with optional Current Probes.

Zoom

Magnifies waveform around the fourth division at the next acquisition (sweep).

METER MODE

Displays up to four readings and a full screen scope waveform of INPUT A.

DC Voltage

Ranges

direct input 100 mV, 300 mV, 1V, 3V, 10V, 30V,
100V, 300V

with 10:1 probe 1V, 3V, 10V, 30V, 100V, 300V, 1 kV,
3 kV (limit 600V)

Accuracy $\pm(0.5\% + 5 \text{ counts})$

Full Scale Reading 1000 or 3000 counts

Normal Mode Rejection $>50 \text{ dB}$ at 50 or 60 Hz

Common Mode Rejection $>100 \text{ dB}$ at DC, 50, 60,
or 400 Hz

AC or AC+DC True RMS Voltage

Ranges

direct input 100 mV, 300 mV, 1V, 3V, 10V, 30V,
100V, 250V

with 10:1 probe 1V, 3V, 10V, 30V, 100V, 300V, 1 kV,
2.5 kV (limit 600V)

Accuracy 50 Hz to 60 Hz $\pm(1\% + 10 \text{ counts})$

(valid from 1 Hz [20 Hz] to 20 kHz $\pm(2\% + 15 \text{ counts})$

5% range) 1 Hz [5 Hz] to 1 MHz $\pm(3\% + 20 \text{ counts})$

1 Hz [5 Hz] to 5 MHz $\pm(10\% + 25 \text{ counts})$

- [values] for "Vrms AC (no DC)", AC coupled input.
- In "AC+DC", the DC component is included in the measurement result and does not influence the accuracy.

Full Scale Reading 1000 or 3000 counts

Crest Factor Automatic ranging on crest factor overload

Common Mode Rejection Ratio..... $>60 \text{ dB}$, DC to 60 Hz

Additional Meter Mode Measurements

FREQUENCY 1 Hz to 5 MHz

Resolution..... 4 digits

Accuracy $\pm(0.5\% + 2 \text{ counts})$

RPM selectable: 1 pulse/rev. or 1 pulse/2 rev.

Range 60RPM (120 @ 1 pulse/2 rev.) to 99.99kRPM

Resolution..... 1 RPM (10RPM for RPM $>10,000$)

Accuracy $\pm(1\% + 10 \text{ counts})$

DUTY CYCLE positive or negative pulse

Range 2.0% to 98.0%

Resolution..... 0.1%

Accuracy (logic or pulse waveforms)..... $\pm(0.5\% + 2 \text{ counts})$

PULSE WIDTH positive or negative pulse.

Range 250 μs to 50 ms

Resolution..... 3 digits

Accuracy $\pm(0.5\% + 2 \text{ counts})$

dBV 1 volt reference

dBm reference @ 50, 60, 75, 93, 110, 125,

135, 150, 250, 300, 500, 600, 800,

900, 1000 or 1200 Ω

dBW or WATTS 1, 2, 4, 8, 16 or 50 Ω reference

Ω MODE

(external 4-mm banana jack inputs)

Ranges 30Ω, 300Ω, 3 kΩ, 30 kΩ, 300 kΩ, 3 MΩ, 30 MΩ
 Accuracy (300Ω to 30 MΩ)..... ±(0.5% +5 counts)
 Accuracy (30Ω)..... ±(2.5% +25 counts)
 Full Scale Reading..... 3000 counts
 Measurement Current..... 500 μA, 500 μA, 70 μA, 7 μA,
 700 nA, 70 nA, 70 nA
 Open Circuit Voltage..... <4V
 Full Scale Voltage <250 mV to 3 MΩ, <2V to 30 MΩ
 Continuity Beeper audible for readings
 <5% of selected range

DIODE TEST MODE

(external 4 mm banana jack inputs)

Open Circuit Voltage.....≤4V
 Full Scale Voltage 2.800V
 Measurement Current..... 0.5 mA
 Continuity Beeperaudible for readings <1V

EXTERNAL mV MODE

Displays up to four readings and a full size waveform of the 4 mm banana jack input.

DC Voltage

Ranges 300 mV, 3V
 Accuracy..... ±(0.5% +5 counts)

Full Scale Reading..... 3000 counts
 Normal Mode Rejection>50 dB at 50 or 60 Hz
 Common Mode Rejection>100 dB at DC, 50, 60,
 or 400 Hz

AC or AC+DC True RMS Voltage

Ranges 300 mV, 3V
 Accuracy DC, 50 Hz, and 60 Hz.
 (valid from >5% of range) ±(2% +15 counts)
 OL at >2250 counts in 3V range
 Full Scale Reading..... 3000 counts
 Crest Factor Automatic ranging on crest factor overload
 Common Mode Rejection Ratio.....>60 dB, DC to 60 Hz

Additional EXternal mV mode measurements

Frequency, RPM, Duty Cycle and Pulse Width measurements and waveforms can also be made with reduced accuracy.

°C / °F TEMPERATURE SCALING for optional temperature probes
 Scaling 1 mV/degree

AMPERE SCALING for optional current probes
 Scaling 1 mV/A, 10 mV/A, 100 mV/A, 1 V/A (1 mV/mA)
 for DC, AC rms, or AC+DC rms

METER, Ω , DIODE, and EXTERNAL mV MODE FUNCTIONS

Smooth Moving average of readings for about last 8 sec.
 Normal..... <3.5 seconds response time for inputs >50 Hz
 Fast<1 second response time for inputs >50 Hz
 Change Alert™ Audible beep when reading changes
 Touch Hold Audible beep & hold of last stable reading
 Relative Zeros present reading as a reference value
 % Change..... % change relative to a reference value
 % Scale % of user set 0% and 100% references
 Min Max..... Simultaneous display of present, maximum,
 minimum, and average values with time

Min Max TrendPlot™

Logs minimum, maximum, and average readings to memory at full accuracy and displays all three as graphs. Uses automatic vertical scaling and horizontal time compression for hands-free recording from 120 seconds to 40 days full screen.

Minimum, maximum, and average full accuracy (16 bit) waveforms available to PC interface ~~92B~~ ~~96B~~.

MEMORIES (SAVE OR RECALL) ~~92B~~

Screen all displayed waveforms, readings, and setup, 10 for Fluke 99B and 105B, 5 for Fluke 96B
 Waveforms individual waveforms with setting, 20 for Fluke 99B and 105B, 10 for Fluke 96B
 Setups complete test tool setting, 40 for Fluke 99B and 105B, 20 for Fluke 96B

SIGNAL GENERATOR ~~92B~~ ~~96B~~

Sine Wave 1V pk-pk at 976 Hz
 Source resistance..... 400 Ω
 Square Wave..... 5V pk-pk at 488 Hz, 976 Hz, or 1.95 kHz
 Source resistance..... 400 Ω

PROBE CALIBRATOR

AC probe adjust at 5pk-pk at 1.95 kHz

COMPONENT TESTER ~~92B~~ ~~96B~~

Current Mode..... 0 to +3 mA in max. 128 steps
 Max. voltage $\leq 2V$
 Voltage Mode..... -2V to +2V in max. 128 steps
 Max. Current +or- 1 mA

GENERAL SPECIFICATIONS

The accuracy of all measurements is within +(% of reading + number of counts) from 18 °C to 28 °C. Add 0.1 x (specific accuracy) for each °C <18 °C or >28 °C.

Display

Foil Compensated Super Twisted Liquid Crystal

Size84 x 84 mm (4.7" diagonal)

Resolution240 x 240 pixels,
25 pixels/div. in SCOPE mode

Contrast User adjustable

Backlight Cold Cathode Fluorescent (CCFL) Tube

High Brightness 50 cd/m²



Power

Internal Battery Pack NiCad 4.8V nominal

Operating Time Typical 4hours

Power Adapter/Battery Charger

Charging Time..... Typical 21 hours

Alternate battery 4 Alkaline C cells (nonrechargeable)

External Supply8 to 20V DC, 6W typical via 5 mm jack



WARNING

THE MINUS VOLTAGE IS CONNECTED TO COMMON. WHEN USING A POWER SUPPLY THAT IS NOT DOUBLE INSULATED, CONNECT COMMON TO PROTECTIVE GROUNDING.

Memory back-up battery ~~92B~~CR2032
save screens, waveforms, and setups for up to three
years after main batteries removed

Mechanical

Size excluding holster 60 x 130 x 260 mm
(2.4 x 5.1 x 10.2 inches)

Size including holster 65 x 140 x 275 mm
(2.5 x 5.5 x 10.8 inches)

Weight excluding holster 1.5 kg (3.3 lbs)

Weight including holster 1.8 kg (4.0 lbs)

Environmental

Temperature

Operating0 °C to 50 °C

Operating with Power Adapter0 °C to 40 °C

Storage -20 °C to 70 °C

Humidity

Operating 20 °C to 30 °C, 90% RH noncondensing
30 °C to 50 °C, 70% RH noncondensing

Storage 95% RH

Altitude

Operating3 km (10,000ft)

Storage12 km (40,000ft)

Shock and Vibrationper MIL-T-28800 for Class 3

Environmental (continued)

Electromagnetic Interferencemeets the following specifications
(see also "DECLARATION OF CONFORMITY" on page XI)

The Fluke 92B, 96B, 99B, and 105B, including standard accessories, conforms with the EEC Directive 89/336 for EMI immunity, as defined by IEC 801-3, with the addition of the following tables.

Scope mode (excluding probe factor):

Table 1

	Susceptibility: no visible disturbance		
Frequency range: 10 kHz to 25 MHz	E = < 0.1V/m	E = 1 V/m	E = 3 V/m
Stand alone	1 mV/div to 100 V/div	1 mV/div to 100 V/div	1 mV/div to 100 V/div
With PM8918	1 mV/div to 100 V/div	1 mV/div to 100 V/div	5 mV/div to 100 V/div

Table 2

	Susceptibility: no visible disturbance		
Frequency range: 25 MHz to 1 GHz	E = < 0.1V/m	E = 1 V/m	E = 3 V/m
Stand alone	1 mV/div to 100 V/div	2 mV/div to 100 V/div	5 mV/div to 100 V/div
With PM8918	1 mV/div to 100 V/div	500 mV/div to 100 V/div	1V/div to 100 V/div

Table 3

	Susceptibility: disturbance less than 10% of full scale		
Frequency range: 10 kHz to 25 MHz	E = < 0.1V/m	E = 1 V/m	E = 3 V/m
Stand alone	-	-	-
With PM8918	-	-	1 mV/div to 2 mV/div

Table 4

	Susceptibility: disturbance less than 10% of full scale		
Frequency range: 25 MHz to 1 GHz	E = < 0.1V/m	E = 1 V/m	E = 3 V/m
Stand alone	-	1 mV/div	1 mV/div to 2 mV/div
With PM8918	-	50 mV/div to 200 V/div	1 V/div to 100 V/div

For conditions not specified in tables 1 to 4, a susceptibility effect of more than 10 % is possible

Multimeter mode (V dc, excluding probe factor):

Table 5

	Susceptibility: no visible disturbance		
Frequency range: 10 kHz to 25 MHz	$E = < 0.1\text{V/m}$	$E = 1\text{ V/m}$	$E = 3\text{ V/m}$
Stand alone	100 mV to 300V	100 mV to 300V	100 mV to 300V
With PM8918	100 mV to 300V	100 mV to 300V	100 mV to 300V

Table 6

	Susceptibility: no visible disturbance		
Frequency range: 25 MHz to 1 GHz	$E = < 0.1\text{V/m}$	$E = 1\text{ V/m}$	$E = 3\text{ V/m}$
Stand alone	100 mV to 300V	100 mV to 300V	100 mV to 300V
With PM8918	100 mV to 300V	300 mV to 300V	3V to 300V

Table 7

	Susceptibility: disturbance less than 10 % of full scale		
Frequency range: 25 MHz to 1 GHz	$E = < 0.1\text{V/m}$	$E = 1\text{ V/m}$	$E = 3\text{ V/m}$
Stand alone	-	-	-
With PM8918	-	100 mV	100 mV to 300 mV

Safety

Designed to Installation Category III per IEC 1010, CSA C22.2 (including approval), and UL1244 (including approval) for 600V measurements on industrial power distributions systems.

MAX. Input voltage on300V rms, 600V rms with
INPUT A or INPUT B 10:1 probe

MAX. Input voltage on EXternal input 300 V rms
Surge Protection 4 kV, 6 kV with 10:1 probe
per IEC 664 and ANSI/IEEE C62.41 test method

Maximum Isolation to Earth600V rms from any terminal
Optical InterfaceOptically Isolated to 600V rms

ACCESSORY INFORMATION**Passive Probe 10:1 (PM8918)**

Attenuation: x10

Useful Bandwidth: 100 MHz

Input resistance: 10 M Ω

Input capacitance: 15 pF

Max. V x Hz: 10⁹

Cable length: 1.5m

Max. signal Voltage: 600V rms

Max. surge Voltage: 6 kV

Max. Voltage to Ground: 600V rms

Double insulated per IEC1010-1 for 600V.

**Optically Isolated RS-232 Adapter /Cable (PM9080/001)**

Serial Printer Interface ~~92B~~ EPSON FX/LQ,
Deskjet Thinkjet, Deskjet, Laserjet
Print screens and waveforms or
log meter and cursor readings

Full PC Interface ~~92B~~ ~~96B~~ Transfer setups,
waveforms, measurements, etc.

Capture Screen.....With FlukeView™ software
(optional for Fluke 92B, 96B and 99B)

Appendix 9B Parts and Accessories

SERVICE MANUAL

Part Number: 4822 872 05368

STANDARD KIT CONTENTS

DESCRIPTION	MODEL	PART NUMBER	REMARK
Yellow Holster	PM9083/001	---	
NiCad Battery Pack (installed)	PM9086/011	---	
Power Adapter/Battery Charger models available:			
Universal Europe 230V, 50 Hz	PM8907/801	---	
North America 120V, 60 Hz	PM8907/803	---	
United Kingdom 240V, 50 Hz	PM8907/804	---	
Japan 100V, 60 Hz	PM8907/806	---	
Australia 240V, 50 Hz	PM8907/807	---	
Universal 115V/230V	PM8907/808	---	
Accessory Case, Soft	C 75	---	

DESCRIPTION	MODEL	PART NUMBER	REMARK
Probe Set 10:1	PM8918/002	---	set of two
10:1 Probe (Red)		5322 210 70139	
10:1 Probe (Grey)		5322 210 70138	
HF Adapter (2 x Black)		5322 263 50193	
Adapter Probe Tip to Banana (Red)		5322 264 20096	
Adapter Probe Tip to Banana (Grey)		5322 264 20097	
High Voltage Test Pin (Red)		5322 264 20087	
High Voltage Test Pin (Grey)		5322 264 20088	
Mini Test Hook (Red)		5322 210 70131	
Mini Test Hook (Grey)		5322 210 70129	
Trim Screwdriver (Red)		5322 395 50417	
Trim Screwdriver (Grey)		5322 395 50416	
Industrial Alligator Clips (Red and Grey)	PM9084/001		set of two
Multimeter Test Lead Set		5322 310 32086	set of two
Test Leads (Red and Black)	TL24	---	set of two
Test Pins (Red and Black)	TP20	---	set of two
Industrial Alligator Clip (Black)	AC20	---	
Banana Adapter (Red)		5322 264 20051	
Banana Adapter (Black)		5322 264 20052	

DESCRIPTION	MODEL	PART NUMBER	REMARK
Probe Accessory Set	PM9094/002	---	
HF Adapter (2 x Black)		5322 263 50193	
Adapter Probe Tip to Banana (Red)		5322 264 20096	
Adapter Probe Tip to Banana (Grey)		5322 264 20097	
High Voltage Test Pin (Red)		5322 264 20087	
High Voltage Test Pin (Grey)		5322 264 20088	
Mini Test Hook (Red)		5322 210 70131	
Mini Test Hook (Grey)		5322 210 70129	
Trim Screwdriver (Red)		5322 395 50417	
Trim Screwdriver (Grey)		5322 395 50416	
Demo Board *)		5322 216 51279	
Self Training Manual *)			
English/German/French/ Spanish/Italian		4822 872 00768	
English/Korean/Japanese/Chinese		4822 872 00769	

*) This item is part of the Self Training Package, supplied on request by product registration within 6 weeks.

DESCRIPTION	MODEL	PART NUMBER	REMARK
Users Manual (English)		4822 872 00724	
Users Manual (German)		4822 872 00725	
Users Manual (French)		4822 872 00726	
Users Manual (Dutch)		4822 872 00727	
Users Manual (Spanish)		4822 872 00728	
Users Manual (Italian)		4822 872 00729	
Users Manual (Danish)		4822 872 00734	
Users Manual (Norwegian)		4822 872 00732	
Users Manual (Swedish)		4822 872 00733	
Users Manual (Finnish)		4822 872 00731	
Users Manual (Chinese)		4822 872 00737	
Users Manual (Japanese)		4822 872 00735	
Users Manual (Korean)		4822 872 00736	

Appendix 9C

PM8907 Information

Your ScopeMeter test tool is powered by a PM8907 Power Adapter /Battery Charger. The version you use depends on the configuration ordered.



WARNING

TO AVOID ELECTRICAL SHOCK, CONNECT THE PM8907 POWER ADAPTER TO THE AC OUTLET BEFORE CONNECTION TO THE SCOPEMETER TEST TOOL.

Five versions are used with the ScopeMeter test tool:

- PM8907/801 Universal European line plug 230V $\pm 10\%$
- PM8907/803 North American line plug 120V $\pm 10\%$
- PM8907/804 United Kingdom line plug 240V $\pm 10\%$
- PM8907/806 Japanese line plug 100V $\pm 10\%$
- PM8907/807 Australian line plug 240V $\pm 10\%$
- PM8907/808 North American line plug and switchable line voltage 115V $\pm 15\%$ or 230V $\pm 15\%$.

The line frequencies for all units are 50, 60, and 400 Hz $\pm 10\%$.

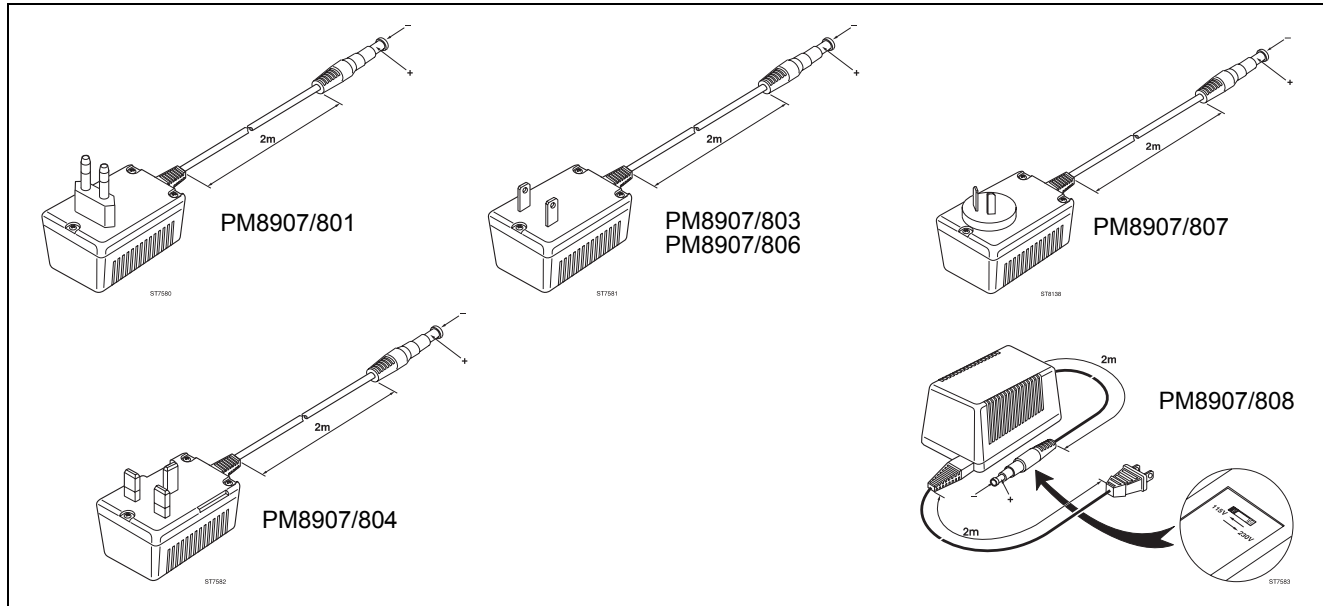

Figure 9C-1. PM8907 Versions

CAUTION

At delivery, the PM8907/808 is set to 230V and is provided with a Power Supply Cord and Attachment Plug that is for use at the 115V setting only. When operating the unit at the 230V setting, you need a North American-to-European line plug adapter.

Before you connect the PM8907/808 to the local line, first check the preselected voltage setting on this unit. You can find the voltage selector switch on the bottom of the PM8907/808. If necessary, select the corresponding line voltage with the slide switch and ensure that the proper voltage is visible in the window of the slide selector (see Figure 9C-1).

Appendix 9D

Warranty and Service Centers

LIMITED WARRANTY & LIMITATION OF LIABILITY

Each Fluke product is warranted to be free from defects in material and workmanship under normal use and service. The warranty period is three years and begins on the date of shipment. Parts, product repairs and services are warranted for 90 days. This warranty extends only to the original buyer or end-user customer of a Fluke authorized reseller, and does not apply to fuses, disposable batteries or to any product which, in Fluke's opinion, has been misused, altered, neglected or damaged by accident or abnormal conditions of operation or handling. Fluke warrants that software will operate substantially in accordance with its functional specifications for 90 days and that it has been properly recorded on non-defective media. Fluke does not warrant that software will be error free or operate without interruption.

Fluke authorized resellers shall extend this warranty on new and unused products to end-user customers only but have no authority to extend a greater or different warranty on behalf of Fluke. Warranty support is available if product is purchased through a Fluke authorized sales outlet or Buyer has paid the applicable international price. Fluke reserves the right to invoice Buyer for importation costs of repair/replacement parts when product purchased in one country is submitted for repair in another country.

Fluke's warranty obligation is limited, at Fluke's option, to refund of the purchase price, free of charge repair, or replacement of a defective product which is returned to a Fluke authorized service center within the warranty period.

To obtain warranty service, contact your nearest Fluke authorized service center or send the product, with a description of the difficulty, postage and insurance prepaid (FOB Destination), to the nearest Fluke authorized service center. Fluke assumes no risk for damage in transit. Following warranty repair, the product will be returned to Buyer, transportation prepaid (FOB Destination). If Fluke determines that the failure was caused by misuse, alteration, accident or abnormal condition of operation or handling, Fluke will provide an estimate of repair costs and obtain authorization before commencing the work. Following repair, the product will be returned to the Buyer transportation prepaid and the Buyer will be billed for the repair and return transportation charges (FOB Shipping Point).

THIS WARRANTY IS BUYER'S SOLE AND EXCLUSIVE REMEDY AND IS IN LIEU OF ALL OTHER WARRANTIES, EXPRESS OR IMPLIED, INCLUDING BUT NOT LIMITED TO ANY IMPLIED WARRANTY OF MERCHANTABILITY OR FITNESS FOR A PARTICULAR PURPOSE. FLUKE SHALL NOT BE LIABLE FOR ANY SPECIAL, INDIRECT, INCIDENTAL OR CONSEQUENTIAL DAMAGES OR LOSSES, INCLUDING LOSS OF DATA, WHETHER ARISING FROM BREACH OF WARRANTY OR BASED ON CONTRACT, TORT, RELIANCE OR ANY OTHER THEORY.

Since some countries or states do not allow limitation of the term of an implied warranty, or exclusion or limitation of incidental or consequential damages, the limitations and exclusions of this warranty may not apply to every buyer. If any provision of this Warranty is held invalid or unenforceable by a court of competent jurisdiction, such holding will not affect the validity or enforceability of any other provision.

Fluke Corporation, P.O. Box 9090, Everett, WA, 98206-9090, USA or Fluke Industrial B.V., P.O. Box 680, 7600 AR, Almelo, The Netherlands

SERVICE CENTERS

To locate an authorized service center, visit us on the World Wide Web:

<http://www.fluke.com>

or call Fluke using any of the phone numbers listed below:

+1-800-443-5853 in U.S.A. and Canada

+31-402-678-200 in Europe

+1-425-356-5500 from other countries

Appendix 9E Terminology

The following list defines special terms used in this manual. The terms are listed in alphabetical order. Words shown in *italics* can be found elsewhere in the list.

AC See "*Alternating Current*."

AC Coupling A mode of signal transmission that passes the dynamic AC signal component to INPUT A and INPUT B but blocks the DC component. Useful to observe an AC signal that is normally riding on a DC signal.

Alternating Current An electrical signal in which current and voltage vary in a repeating pattern over time.

Amplitude The difference between the highest and lowest level of a *waveform*.

Attenuation The decrease in *amplitude* of a signal.

Average A processing technique to obtain the average value of a *repetitive* signal, useful to eliminate *noise*.

Auto Set Adjusts voltage scale and time base based on the characteristic of the active waveform, and automatically produces a stable *waveform* of usable size.

Backlight A light that brightens the *display*, useful for improving visibility in dark surroundings.

Bandwidth The range of *frequencies* that the ScopeMeter test tool can display accurately with no more than -3 dB (.7x) *attenuation* of the original signal.

Battery Save This feature enables the ScopeMeter test tool to shut itself down when running on batteries if the battery level is too low or if the test tool is not operated.

BNC Coaxial-type input connector used for INPUT A and INPUT B.

Bottom Display The lower part of the *display*, where the *function key* menu is listed.

Capture 10 Divisions Records and displays 10 time divisions.

Capture 20 Divisions Records and displays 20 time divisions although the *display* shows only 10 at a time. Horizontal "Move" allows you to view the additional 10 divisions.

Continuous Auto Set Automatically selects the optimum settings for connected input signals and keeps track of any variation of the signal.

Contrast Contrast of the LCD. Can be adjusted as desired.

Cursors Movable display lines that allow you to make measurements between two locations on a *waveform*.

dB See "*decibel*."

DC See "*Direct Current*."

DC Coupling A mode of signal transmission that passes both AC and DC signal components to the INPUT A and INPUT B circuit (see also *AC Coupling*).

Decibel Measurements that indicate voltage or power comparison in a logarithmic scale.

Delta % Percentage change (delta) uses the present numerical reading as a relative reference. The display then shows a percentage that represents the difference between each new reading and the relative reference.

Delay Time The time between the trigger event and the real acquisition of the waveform.

Delta Time (dt) The change in time. The ScopeMeter test tool displays the amount of time displayed between the (vertical) *cursors*.

Digital Storage Capability Because of the design of digital oscilloscopes, signals are not displayed at the moment they are acquired. Instead, signals are first stored in memory, then sent to the *display*. This enables the ScopeMeter test tool to present several options when displaying information, including "negative delay."

Direct Current A signal with a constant voltage and current.

Display The Liquid Crystal Display area of the ScopeMeter test tool that is used to display all information, such as readings, *waveforms*, and text.

Division A part of a *waveform*, as defined alongside the lines of the grid on the *display*.

Dual Trace A feature that allows the ScopeMeter test tool to display two separate live *waveforms* at the same time.

Duty Cycle Ratio of a *waveform* with respect to the total *waveform* period, as measured in percent.

Earth Ground Reference point that is directly connected to the *ground* via a conductor.

Envelope The display of a *waveform* that shows the variation extremes of several acquisitions (see also *Min Max*).

Events Triggering via red 4-mm banana jack input (EXT) is delayed by a number of events that occur on INPUT A.

Falling Slope The part of a *waveform* that shows the voltage decreasing.

Filter Reduces or removes certain electrical components from a *waveform* (active input or memory). Is useful to suppress *noise* or to smooth a *waveform*.

Free Run Allows the ScopeMeter test tool to display a *waveform* without a *trigger*.

Freeze *Holds* a *waveform* acquisition: freezes the *display* for closer examination (see also Hold).

Frequency The number of times a *waveform* repeats in 1 second, measured in *Hertz* (Hz) where one Hz is one cycle per second.

Function keys The five blue keys along the top of the keypad. They change function based on the present mode or settings. Function key definitions appear in the *Bottom Display*.

Glitch A momentary spike in a *waveform*.

Glitch Detect Feature of ScopeMeter that increases its sampling rate to maximum so that *glitches* can be detected.

GND See "*Ground level*."

Ground level The voltage reference point in a circuit. It is indicated with "-" on the display.

Hard Copy A copy on paper of the *display*, made by a printer via the optical RS-232 interface.

Hertz (Hz) Unit of measure to count the number of times that an electrical cycle repeats every second. One Hertz is one cycle per second.

Hold Allows you to *freeze* the *display* for closer examination.

Input Coupling Modes of signal transmission for INPUT A and INPUT B: AC coupling, DC coupling, and GND (Scope only).

Input selection Select if and how the INPUTS A and B are displayed in Scope mode. This can be normal display, inverted display, or neither.

Interface Isolated optical to RS-232 Interface port for printer output and computer interfacing.

Liquid Crystal Display (LCD) A *display* that uses liquid crystals to display *waveforms* and text on its screen.

Main Display The center *display* area that shows measurement results or displays the *waveform(s)*.

Marker Identifies the point on the waveform on which a measurement has occurred or is expected to occur. The marker appears as an "X".

Master Reset Procedure to restore the ScopeMeter test tool to a set of initial standard settings.

Maximum Peak The highest voltage value of a waveform.

Menu A list of choices on the *display* to select functions via the five *function keys*.

Messages On-line information for the user, provided in situations where there is a conflict.

Meter Mode In this setting, the ScopeMeter test tool works like a digital multimeter, presenting information in numerical readings, and with a reduced Scope *display*.

Minimum Peak The lowest voltage value of a *waveform*.

Min Max Envelope Scope mode feature that displays changes in the shape of a live waveform as a grey area around the actual trace.

N-Cycle Trigger function, the input signal is divided by N before a trigger occurs. This creates a stable picture for *waveforms* with a cyclic character.

Noise Extraneous electrical signal, mostly unwanted.

Non-Repetitive Pulse A random electrical *waveform*, with no specific pattern or frequency.

Oscillations The up-and-down peaks of a *waveform*. One oscillation consists of one complete up-peak and one complete down-peak.

Oscilloscope A device for viewing and diagnosing electrical signals such as *waveforms*.

Peak-to-Peak The highest and lowest voltage value of a *waveform*.

Percentage of Pulse Width The ratio of signal on-time to its total cycle time, as measured in percent.

Probe Calibration A procedure that adjusts the ScopeMeter test tool internally to compensate for resistance variations between probes.

Probes Measuring conductor that connects the ScopeMeter test tool to a circuit; specifically for use in the BNC jacks.

Pulse A *waveform* that increases from a constant value, then decreases to its original value.

Pulse Trains A repetitive series of pulses.

Pulse Width The duration from the beginning to the end of a signal's on-time or off-time.

Range The quantity between two points or levels.

Recall The function of loading a stored *Setup*, *Screen*, or *Waveform* back into the ScopeMeter test tool.

Recurrent The ScopeMeter test tool continuously (recurrently) updates the display. This gives a dynamic look at the *waveform* activity as it occurs.

Repetitive Pulse A signal with a regular pattern or *frequency*.

Rise Time The time between the 10% and 90% points of the first slope after the left cursor of a *waveform*.

Rising Slope The part of a *waveform* displaying a rise in voltage.

Root Mean Square (RMS) Conversion of AC voltages to the effective DC value.

Roll Visual log of a *waveform* activity that is useful when measuring lower frequency signals.

RPM Engine speed expressed in Revolutions Per Minute.

Sample A momentary reading taken from an input signal. The ScopeMeter test tool takes a series of samples to display a *waveform*.

Sampling Rate The number of samples taken from a signal every second.

Screen The complete image of the *display*.

Scope Mode In this mode, the ScopeMeter test tool works like a digital *oscilloscope*.

Setup Series of adjustments necessary for the ScopeMeter test tool to display a *waveform* or reading.

Sine Wave A common curved *waveform* that is mathematically defined.

Single Shot Allows the ScopeMeter test tool to capture a single event.

Smooth (Scope) Averages multiple *samples* of a *waveform*. Useful to suppress noise without loss of *bandwidth*.

Square Wave A common *waveform* that consists of repeating square pulses.

Sweep Speed see "Time Base"

Time Base The time defined per horizontal division on the *display*, expressed in seconds per division.

Time Delay The time between the *trigger* event and the real acquisition of the *waveform*.

Top Display The upper edge of the *display*, where the ScopeMeter test tool lists probe calibration, voltage scale, *time base*, *input coupling*, and *trigger* information.

Trace The displayed *waveform* that shows the voltage variations of the input signal as a function of time.

Trigger Determines the beginning point of a *waveform*.

Trigger Level The voltage level that a waveform must reach before the ScopeMeter test tool will read in.

Trigger Slope The voltage direction necessary for the ScopeMeter test tool to begin its *trace*. A positive slope requires the voltage to rise as it crosses the *trigger level*. A negative slope requires the voltage to fall.

Trigger Source The signal that triggers the ScopeMeter test tool. This can be the *waveform* being viewed, or it can come from another *waveform*.

Voltage Spike A momentary increase or decrease in voltage (see also *Glitch*).

Waveform The pattern defined by an electrical signal.

Window A list of functions from which you can choose. You open a window with the F1-(MORE) function key. You close the window with the F1-(CLOSE) function key.

Zoom Displays a live *waveform* with increased time resolution, giving up to 1000x magnification.

Symbol

°C Probe, 3-4

°F Probe, 3-4

Ω Mode, 3-4, 4-4, 9-7

✦ Mode, 3-4, 4-5, 9-7

, 1-13

Numerics

0%-100%, 4-15

1/dt, 3-8, 3-13, 6-4

10:1 Probes, 2-4

15-Minute Demonstration, 2-2

20 Divisions, 5-10

4-Field Sequence, 5-18, 5-19

4-mm Banana Jack, 1-7

A

A AC, 3-6

A AC+DC, 3-6

A DC, 3-6

Ampere Measurements, 3-6

A versus B, 5-26

A+B, 5-26

A-B, 5-26

AC-Coupling, 5-4

Accessory Information, 9-9

Accessories, 9-13

Accessory, 3-4

Adapter/Cable, 1-8, 6-14

Adapting the Display, 5-27

Add, 5-26, 6-11

Add Main Reading, 4-14, 6-3

Adjust Level, 5-14

Adjusting the Amplitude, 5-5

Alert, 4-5, 4-13

Alkaline C Cells, 9-8

Alligator Clips, 9-16

Altitude, 9-9

Ampere Scaling, 9-7

Amplitude, 5-5

Auto Level, 5-14

Auto Range, 4-7

Auto Set, 2-5, 6-22

Auto Set Configuration, 6-22

Automotive Adapter, 1-4

Average, 5-11, 9-4

Average Readings, 4-13

B

Backlight, 2-3, 9-8

Banana Jack, 4-2

Banana Jack Inputs, 1-7

Basic Functions, 2-14

Batteries in Optimal Condition, 8-2

Battery Charger, 1-4, 9-19

Battery Pack, 1-4, 9-8

Battery Replacement, 8-4
Battery Save Feature, 8-3
Beeper Alert, 4-5, 4-13
BNC Jack, 1-7
Bottom Display, 1-9

C

Calibrating the Probes, 8-5
CANCEL Key, 1-12
Capabilities, 1-2
Capturing 10 or 20 Divisions, 5-10
Capturing Glitches, 5-5
Caution Statements, VIII
CE, XI, 9-10
Change Alert, 4-13, 9-7
Characteristics, 9-3
Charger, 1-4
Charging the Battery, 1-6, 8-2
Cleaning, 8-2
Clear at Run, 6-21
Close key, 1-12
COM (Common), VIII
Combinations with INPUT A and INPUT B, 5-26
Common Ground, 1-7
Common Measurements, 3-9
Common Mode Rejection, 9-5, 9-7
Component Test, 6-17, 9-8
Computer Interface, 1-7
Connections, 1-7, 3-2, 4-2, 5-3

Continuity, 3-4
Continuity Test, 3-2
Continuous Auto Set, 2-5, 5-4, 9-4
Continuous Auto Set Configuration, 6-21
Contrast, 2-3, 9-8
Controlling the inputs A and B, 5-4
Copying Waveforms, 6-8
Crest Factor, 9-6, 9-7
Current Measurement, 7-4
Current Probe, 7-4, 9-7
Cursor Measurements, 9-5
Cursors, 6-2, 9-5

D

Date and Time, 6-19
Date Setting, 6-20
dB List Box, 3-9
dBm, 3-7, 9-6
dBm AC, 3-7
dBm AC (no DC), 3-10
dBV, 3-5, 9-6
dBV AC (no DC), 3-11
dBV AC+DC, 3-11
dBW, 3-7, 9-6
dBW AC (no DC), 3-11
dBW AC+DC, 3-11
DC-Coupling, 5-4
DC Voltage, 9-5, 9-7
Default Readings, 4-14

Default Settings, 6-20
Default Startup, 2-4
Delay, 5-14
Delay Time, 9-5
Delete Menu, 6-6
Deleting Memories, 6-6
Delta Time, 3-8
Diode, 3-4
Diode Test, 3-2, 4-5, 9-7
Display, 1-8, 2-3, 9-9
Disposing of Batteries, 8-3
Dot Size, 5-27
dt, 3-8, 3-12, 6-4
Dual Display, 1-9
Duty Cycle, 3-7, 9-6
dV, 3-5, 6-4

E

Earth Ground, VIII
Easy Setup, 2-5
Electrical Shock, IX
Electrically Floating, VIII
Electro-Magnetic Interference, 9-9
Environmental, 9-9
Environmental Data, 9-3
Error messages, 1-13
Events, 5-14, 9-5
External mV Mode, 4-6, 9-7
External Trigger, 5-13

F

Fast Refresh Rate, 4-13
Fault Protection, VIII
Features, 1-2
Field Odd/Even, 5-18
Filter, 6-13
Frame, 5-15
Freeze, 4-10
Frequency, 3-8, 6-5, 9-6
Frequency Measurements, 3-9
Function Keys, 1-11
Fuses, 8-5

G

Generator, 6-17, 9-8
Glitch detection, 5-5, 9-4
Grey-Scale Display, 9-4
Grid, 5-27
Ground, VIII

H

Heavy Duty Industrial Measurements, *XIII*
Help Function, 1-13
Help Level, 6-21
HF Adapter, 1-7, 4-2
High Frequency Electronic Measurement, *XII*
Hold, 4-10
Holster, 1-3, 9-15
Humidity, 9-9
Hz, 3-7, 6-5, 9-6

I

Industrial Alligator Clips, 9-16
Information Level, 6-21
Information Mode, 1-13
INPUT A, 1-7, 5-4
INPUT A BNC jack, 4-2
INPUT B, 1-7, 5-4
INPUT B BNC jack, 4-2
Input Connectors, *VIII*
Input Coupling, 5-4
Input Impedance, 9-4
Integrate, 6-12
Invert, 5-5, 6-12
Isolated, *VIII*
Isolated Measurement, *X*

K

Keypad, 1-10

L

Level, 5-14
Limitation of Liability, 9-21
Lines, 5-15
Low Frequency Measurements, 1-7

M

Main Display, 1-9
Main Mode, 4-3
Main Reading, 6-4
Manual Range, 4-5, 4-7
Markers, 6-3, 9-5
Master Reset, 2-4, 6-20
Math Functions, 6-11, 7-7
Mathematics, 9-5
Measure Menu, 3-3, 9-4
Measurement Connections, 4-2
Measurements, 6-3
Mechanical, 9-9
Memories, 9-8
Memory Back-Up Battery, 9-9
Messages, 1-13
Meter, 4-4

Meter Operations, 2-10, 2-11, 2-12
Min Max, 4-9, 9-7
Min Max Envelope, 5-21, 5-22, 9-4
MIN MAX Recording, 4-9
Min Max Scaling, 4-16
Min Max Zero Δ , 4-16
Mini Testhook, 1-7, 4-2
MORE Function Key, 1-11
More INPUT A, 5-26
More INPUT B, 5-26
More Measure, 3-3
More Save, 6-6
More Scope, 6-3
More Scope Window, 5-10
More Submenu, 4-13
More Trigger, 5-13
Multimeter Test Lead Set, 9-16
Multiple Waveforms, 5-26
Multiply, 6-12

N

N-Cycle, 5-14, 9-5
NiCad Batteries, 1-4, 8-2, 9-8
Noise, 1-5
Noise Suppression, 6-13
Normal Mode Rejection, 9-5, 9-7
Number of Readings, 4-14

O

Ohm, 3-4, 4-4, 9-6
Ohm Measurement, 3-2
On-Line Information, 1-13
Optical Interface, 1-7, 6-14, 9-9
Ordering Measurement Readings, 3-10
Overload Protection, 9-9

P

Parts, 9-13
PC Interface, 9-13
Percent Change, 4-15
Percent of Scale, 4-15
Persistence, 5-27, 6-16
Phase, 3-11, 6-5
Phase Measurement, 7-12
Positioning the Waveform, 5-7
Power Adapter, 1-4, 9-19
Power Measurements, 3-9, 7-7
Powering, 1-4
Print Options, 6-14
Printer, 6-14
Printer Types, 6-14
Probe, 9-9
Probe Accessory Set, 9-16
Probe Calibration, 8-5
Probe Calibrator, 9-8

Probe Set 10:1, 9-16
Probe Type, 2-4
Protection, X
Pulse Response, 7-14
Pulse Width, 3-7, 9-6

Q

Quick Measurement Demonstration, 2-7, 2-8, 2-9
Quick Operating Guide, 1-3, 9-18

R

Recall, 9-8
Recalling a Screen, 6-8
Recalling a Setup Configuration, 6-10
Record, 4-9
Record Length, 9-5
Recurrent, 5-6, 9-4
Recycling, 8-3
Replacing the Batteries, 8-3
Reset Configurations, 6-20
Resistance Mode, 4-4
Reversing the Polarity, 5-5
Rise Time, 3-8, 6-5, 7-15, 9-4
Roll, 5-6, 9-4
RPM, 9-6
RPM 1, 3-8
RPM 2, 3-8
RS-232, 1-8, 6-14
RS-232 Adapter, 9-13

S

Safety, VIII, 9-13
Safety Characteristics, 9-3
Safety-Protection, X
Save, 9-8
Save Waveform, 6-7
Saving a Screen, 6-7
Saving a Setup, 6-7
Saving Battery Life, 1-6
Scale Result, 6-11
Scaling, 4-14, 6-3
Scaling the Display, 6-11
Scan Rate, 5-16
Scope, 4-3
Scope Display, 1-9
Scope Mode, 1-7
Scope Operations, 2-13, 2-14, 2-15
ScopeRecord, 5-22
Scope Submenu, 5-10
Screen, 6-7, 9-8
SELECT ITEM Key, 1-12
Select Line, 5-18
Selecting the Input, 5-4
Serial Printer Interface, 9-13
Setup, 6-7
Setups, 9-8
Shock, 9-9
Single Shot, 9-4
Single-Phase Circuit, 7-7
Slow Ramp, 6-17

Smooth, 4-13, 9-7
Smoothing, 6-13
Special Functions Menu, 6-11, 6-17
Specifications, 9-3
Speed Up the Refresh Rate, 4-13
Stable Measurement, 4-8
Stand, 1-3
Start Printing, 6-16
Submenu, 4-13
Subtract, 5-26, 6-11
Supply, 9-8
Surge Protection, 9-9
Symbols, VIII

T

Temperature, 9-9
Temperature Measurement, 7-2
Temperature Probe, 3-4, 7-2
Temperature Scaling, 9-7
Testing Components, 6-17, 9-8
Three Lead Connection, IX
Three-Phase, X
Three-Phase Measurement, 7-9
Tilt Stand, 1-3
Time Base, 5-6
Time Delay, 5-14
Time Measurements, 3-9
Time Setting, 6-19
Top Display, 1-9
Touch Hold, 4-8, 9-7

Trace Quality, 5-27
Trace Start, 5-13
Trend Plot, 4-9, 9-7
t1 from TRIG, 3-11, 6-5
t2 from TRIG, 3-11, 6-5
Trigger, 9-5
Trigger Basics, 5-12
Trigger Delay, 5-14
Trigger Icon, 5-5
Trigger Level, 5-14
Trigger Slope, 5-13
Trigger Source, 5-13
True RMS Voltage, 9-6
TV Triggering, 5-15
TV System, 5-16

U

Unpacking, VII
User Options Menu, 6-21
Users Manual, 9-18

V

V1 left, 3-11, 6-5
V2 right, 3-11, 6-5
V DC, 3-5
V DC (mean), 3-5, 6-5
V Max Peak, 3-5, 6-5
V Min Peak, 3-5, 6-5
V peak/peak, 3-5, 6-5
Vertical Resolution, 9-4
Vibration, 9-9
Video, 5-16
Voltage Measurements, 3-9
Vrms, 3-5, 6-5
Vrms AC, 3-5
Vrms AC (no DC), 3-10
Vrms AC+DC, 3-5

W

Wait for Trigger, 5-13
Warning And Caution Statements, VIII
Warranty, 9-21
Watt, 3-11, 9-6
WATT AC (no DC), 3-11
WATT AC+DC, 3-11
Waveform Area, 1-9
Waveform Generator, 1-7
Waveform Math Functions, 6-11

Waveforms, 6-7, 9-8
Window, 1-11
Window Display, 1-9

Y

Yellow Holster, 1-3, 9-15

Z

Zero Δ , 4-14
Zero $\Delta\%$, 4-15
Zoom, 5-8, 9-5