

8423

Instruction Manual

MEMORY HiLOGGER



This manual describes the Memory HiLogger's functions and operation in detail, and its specifications.

EN

Contents

1

2

3

Introduction.....	1
Verifying Package Contents	2
Safety Information	4
Operating Precautions.....	6
Chapter 1 Overview	9
1.1 Product Overview	9
1.2 Features	10
1.3 Names and Functions of Parts	12
1.4 System Configuration	15
1.5 Measurement Flowchart	16
Chapter 2 Installing the Software	17
2.1 Installing Logger Utility	18
2.2 Installing the USB Driver	21
2.3 Connect the instrument and computer with the USB cable provided	25
2.4 Starting and Ending Logger Utility	28
2.5 Uninstalling the Logger Utility	30
Chapter 3 Setting Up the Instrument	31
3.1 Attaching Units	32
3.1.1 Unit Types	32
3.1.2 Attaching a Unit	33
3.2 Connecting a Cable to the Terminal Block	35
3.2.1 Removing and Attaching a Terminal Block	35
3.2.2 Connecting a Cable	37
3.3 Installing the Memory HiLogger	40
3.3.1 Mounting to a Wall Surface with Screws	40
3.3.2 Securing with a DIN Rail	41
3.4 Connecting the AC Adapter	42
3.5 Connecting a Communication Cable	43
3.5.1 Connecting the USB Cable	43
3.5.2 Connecting the LAN Cable	44
3.6 Using a CF Card	45

3.6.1	Formatting a CF Card	45
3.6.2	Inserting and Ejecting a CF Card	46
3.6.3	Replacing a CF Card during Measurement	47
3.6.4	File Protection during Power Outage	47
3.7	Connecting Synchronization Cables	48
3.8	Connection Method for External Control Input Terminals ..	50
3.9	Turning the Power On and Off	52

Chapter 4 Software Screen _____ 53

4.1	Main Screen	53
4.2	Settings Screens	56
4.3	Display Settings Windows	60
4.4	Channel Indication on Screens	61

Chapter 5 Setting Measurement Conditions ____ 63

5.1	Registering Loggers in Logger Utility	64
5.1.1	Searching and Registering	64
5.1.2	Registering Manually	68
5.1.3	Settings for Synchronized Measurement	74
5.2	Confirming the Unit Configuration (Digital Filter Setting) ..	75
5.3	Configuring Basic Settings for Measurement	77
5.3.1	Setting Function and Recording Interval	77
5.3.2	File Save Settings	82
5.3.3	Comment Input	84
5.3.4	Recording Settings	85
5.4	Advanced Settings for Each Channel	89
5.4.1	Setting Measurement Conditions	89
5.4.2	Waveform Calculation Settings	96
5.4.3	Setting the Display Method	98
5.4.4	Assigning Channels to Sheets	103
5.5	Setting the Trigger Function	105
5.5.1	Recording Operation during Simultaneous Use of Timer Measurement and Triggers	105
5.5.2	Pre-trigger	109
5.5.3	Trigger Timing	111
5.5.4	Trigger Sources	112
5.5.5	External Triggers	113
5.5.6	Analog Triggers	114
5.5.7	Logic Triggers	117
5.6	Setting the Alarm Function	118

5.7	Setting Environment Conditions	121
5.7.1	Setting External Control Input Terminals	121
5.7.2	CF Card Save Settings	123
5.7.3	Time Value Display	125
5.7.4	Start Backup	126
5.8	Send Settings	127
5.9	Process All	128
5.10	Narrowing Down of Display Channels	129

Chapter 6 Starting and Stopping Measurement 131

6.1	Pre-Operation Inspection	134
6.2	Starting and Ending Measurement	135
6.2.1	Computer Based Measurement	135
6.2.2	Standalone Measurement	137

Chapter 7 Analyzing Measurement Data _____ 139

7.1	Changing the Waveform Display Range	140
7.2	Checking Cursor Values	141
7.3	Changing Display Settings	142
7.3.1	Switching between Waveform Display and List Display	142
7.3.2	Waveform Display Settings	143
7.3.3	List Display Settings	148
7.3.4	Common Settings and Auto Update Settings	149
7.4	Calculations	150
7.4.1	Calculation Settings	150
7.4.2	Numerical Calculation Expressions	152
7.5	Event Mark Function	153
7.5.1	Adding a Mark (Event Mark) to a Waveform	153
7.5.2	Searching for and Editing Event Marks	154
7.6	Searching for the Maximum Value, Minimum Value, and Variation	155
7.7	Displaying the Channel List	159
7.8	Confirming Measurement Conditions	160
7.9	Monitor Display	161

Chapter 8 Saving and Reading Data _____ 163

8.1	Saving and Reading Measurement Data	164
8.1.1	Saving Measurement Data as Text	164
8.1.2	Converting Measurement Data to an Excel File	167

8.1.3	Reading Measurement Data	169
8.2	Saving and Reading Setting Data	170
8.2.1	Saving Setting Data	170
8.2.2	Reading Setting Data	170
8.3	Automatically Transferring Measurement Data to Excel .	171
8.3.1	Real-Time Transfer Settings	171
8.3.2	Real-Time Transfer Example	172
8.4	Notes in Windows Vista /7	173

Chapter 9 Printing _____ 175

9.1	Setting the Printing Range	176
9.2	Settings for Waveform Print Options	177
9.3	Settings for the Appendix	179
9.4	Printer Settings/Printing	179
9.5	Copy to Clipboard	180
9.6	Print Example	181

Chapter 10 Setting Method for Logger _____ 185

10.1	Setting Method	186
10.2	Synchronized Measurement	187
10.3	Date	188
10.4	Time	189
10.5	DHCP	190
10.6	IP Address	191
10.7	Subnet Mask	192
10.8	Port Number	193
10.9	Gateway	194
10.10	Display Language	196
10.11	Self Check	197
10.11.1	ROM Check	197
10.11.2	RAM Check	198
10.11.3	BUS Check	199
10.11.4	Key Check	200
10.11.5	LED Check	201
10.11.6	LCD Check	202
10.12	Displaying Individual Version Information	203
10.12.1	ROM Version	203
10.12.2	FPGA Version	204

10.12.3 MAC Address	205
10.12.4 Serial No.	206
10.13 Reading and Writing a Setting File	207
10.13.1 Writing a Setting File	207
10.13.2 Reading a Setting File	208
Chapter 11 Communications (HTTP/FTP) _____	209
11.1 Displaying the Main Page	209
11.2 Starting and Stopping Measurement	210
11.3 Current Value Display	211
11.4 Acquiring Data from Memory	212
11.5 Data Acquisition using FTP	213
Chapter 12 Specifications _____	215
12.1 General Specifications	215
12.2 Application Software	219
12.3 Unit Specification	221
12.3.1 Model 8948 Voltage/Temp Unit	221
12.3.2 Model 8949 Universal Unit	223
12.3.3 Model 8996 Digital/Pulse Unit	226
12.3.4 Model 8997 Alarm Unit	227
12.4 Dimension Diagrams	228
Chapter 13 Maintenance and Service _____	231
13.1 Cleaning	231
13.2 Troubleshooting	232
13.3 Initializing Settings (System Reset)	233
13.4 Zero-position Calibration (Zero Adjustment)	234
13.5 Industrial Waste	235
Appendix _____	A 1
Appendix 1 Scan Timing	A 1
Appendix 2 Version Update.....	A 2
Appendix 3 Error Display.....	A 3
Appendix 3.1 Application Software	A 3
Appendix 3.2 8423 Memory HiLogger Main Unit	A 5
Appendix 4 Recording Intervals and Maximum Times for Recording to CF Cards.....	A 7

Contents

Appendix 4.1 Model 9726 PC Card 128M	A 8
Appendix 4.2 Model 9727 PC Card 256M	A 10
Appendix 4.3 Model 9728 PC Card 512M	A 12
Appendix 4.4 Model 9729 PC Card 1G	A 14

Index _____ **Index 1**

Introduction

Thank you for purchasing the HIOKI "Model 8423 Memory HiLogger." To obtain maximum performance from the instrument, please read this manual first, and keep it handy for future reference.

The 8423 Memory HiLogger is a data collection instrument for use connected to a computer. This method of measurement is referred to as "computer based" within this manual. The supplied software Logger Utility is used to set measurement conditions, start measurement, and otherwise control the instrument. Install the software while referring to "Chapter 2 Installing the Software" (p. 17). You can also attach units to the instrument in accordance with the measurement object. For details, refer to the manuals supplied with the units.

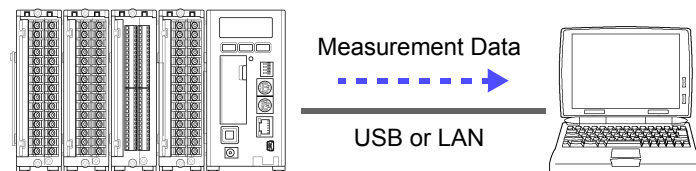

The following instruction manuals are included with the 8423 Memory HiLogger. Refer to them as they pertain to your usage of the instrument.

Manuals	Contents
1 Quick Start Manual	Read first. Offers an introduction to the 8423's basic measuring method for first time users.
2 Instruction Manual (this manual)	Contains explanation and instructions regarding the instrument's operating method and functions.

Registered Trademarks

- Windows, MS-DOS, and Excel is a registered trademark of Microsoft Corporation in the United States and/or other countries.
- Pentium is a registered trademark of Intel Corporation.

Verifying Package Contents

When you receive the instrument, inspect it carefully to ensure that no damage occurred during shipping. In particular, check the accessories, panel switches, and connectors. If damage is evident, or if it fails to operate according to the specifications, contact your dealer or Hioki representative.

Please check to make sure that no items are missing from your package.

Model 8423 Memory HiLogger 1

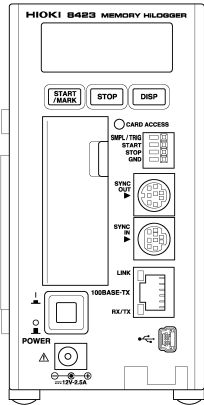

Quick Start Manual 1
 Instruction Manual 1

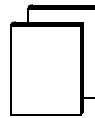

Logger Utility CD (data collection software) 1
 (The latest version can be downloaded from our web site.)



Model 9418-15 AC Adapter 1

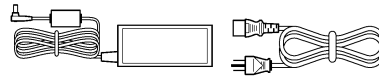

USB Cable 1

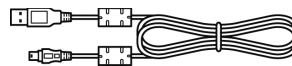

Connector Cover 1



Ferrite Clamp 1

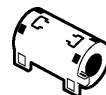

Connection Plate 1



Options

The following options are available.

Model 8948 Voltage/Temp Unit

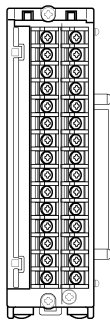

Model 8949 Universal Unit

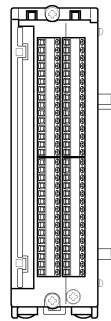

Model 8996 Digital/Pulse Unit

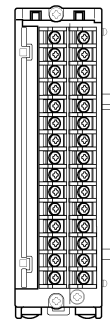

Model 8997 Alarm Unit

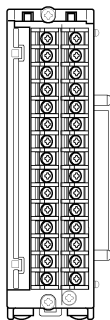

Model 9418-15 AC Adapter

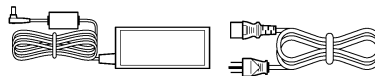

Model 9642 LAN Cable

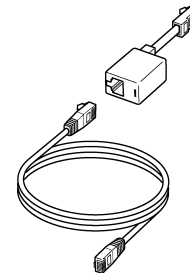

Model 9683 Connection Cable (for synchronization)

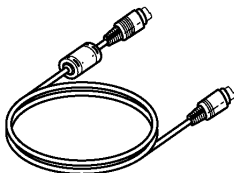

Model 9701 Humidity Sensor

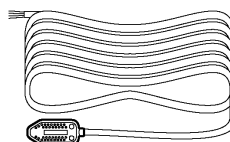

Model 9726 PC Card 128M

Model 9727 PC Card 256M

Model 9728 PC Card 512M

Model 9729 PC Card 1G

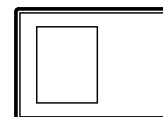









Safety Information







This instrument is designed to comply with IEC 61010 Safety Standards, and has been thoroughly tested for safety prior to shipment. However, mishandling during use could result in injury or death, as well as damage to the instrument. Be certain that you understand the instructions and precautions in the manual before use. We disclaim any responsibility for accidents or injuries not resulting directly from instrument defects.

This manual contains information and warnings essential for safe operation of the instrument and for maintaining it in safe operating condition. Before using it, be sure to carefully read the following safety precautions.

Safety Symbols

	In the manual, the  symbol indicates particularly important information that the user should read before using the instrument.
	The  symbol printed on the instrument indicates that the user should refer to a corresponding topic in the manual (marked with the  symbol) before using the relevant function.
	Indicates DC (Direct Current).
	Indicates AC (Alternating Current).
	Indicates a ground.
	Indicates the ON side of the power switch.
	Indicates the OFF side of the power switch.

The following symbols in this manual indicate the relative importance of cautions and warnings.

	Indicates that incorrect operation presents an extreme hazard that could result in serious injury or death to the user.
	Indicates that incorrect operation presents a significant hazard that could result in serious injury or death to the user.
	Indicates that incorrect operation presents a possibility of injury to the user or damage to the instrument.
	Indicates advisory items related to performance or correct operation of the instrument.

Notation



Indicates a prohibited action.



Indicates quick references for operation and remedies for troubleshooting.

*

Indicates that descriptive information is provided below.

Accuracy

We define measurement tolerances in terms of f.s. (full scale) with the following meanings:

f.s. (maximum display value or scale length)

The maximum displayable value or scale length. This is usually the name of the currently selected range.

Measurement Categories

This 8423's unit complies with CAT II safety requirements.

To ensure safe operation of measurement instruments, IEC 61010 establishes safety standards for various electrical environments, categorized as CAT II to CAT IV, and called measurement categories. These are defined as follows.

CAT II	Primary electrical circuits in equipment connected to an AC electrical outlet by a power cord (portable tools, household appliances, etc.) CAT II covers directly measuring electrical outlet receptacles.
CAT III	Primary electrical circuits of heavy equipment (fixed installations) connected directly to the distribution panel, and feeders from the distribution panel to outlets.
CAT IV	The circuit from the service drop to the service entrance, and to the power meter and primary overcurrent protection device (distribution panel).

Using a measurement instrument in an environment designated with a higher-numbered category than that for which the instrument is rated could result in a severe accident, and must be carefully avoided.

Use of a measurement instrument that is not CAT-rated in CAT II to CAT IV measurement applications could result in a severe accident, and must be carefully avoided.

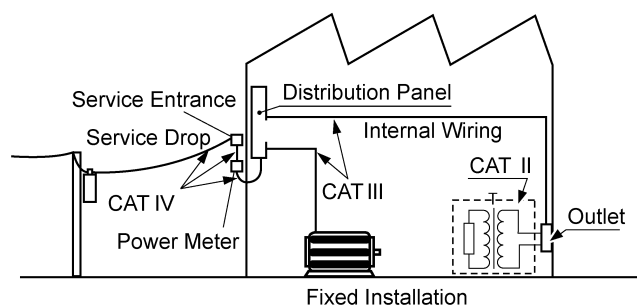

Operating Precautions



Follow these precautions to ensure safe operation and to obtain the full benefits of the various functions.

Preliminary Checks

Before using the instrument the first time, verify that it operates normally to ensure that no damage occurred during storage or shipping. If you find any damage, contact your dealer or Hioki representative.



Before using the instrument, make sure that the insulation on the cables is undamaged and that no bare conductors are improperly exposed. Using the instrument in such conditions could cause an electric shock, so contact your dealer or Hioki representative for replacements.

Installing the Instrument

Operating temperature & humidity:
0 to 40°C (32 to 104°F), 30 to 80%RH (non-condensating)
Operating temperature & humidity for guaranteed accuracy:
23 ± 5°C (73 ± 9°F), 30 to 80%RH

Avoid the following locations that could cause an accident or damage to the instrument.



Exposed to direct sunlight
Exposed to high temperature



In the presence of corrosive or explosive gases



Exposed to liquids
Exposed to high humidity or condensation



Exposed to strong electromagnetic fields
Near electromagnetic radiators



Exposed to high levels of particulate dust



Subject to vibration

Installing the instrument

In addition to placing this instrument on a flat surface, you can also mount it on a DIN rail or a wall surface. See "3.3 Installing the Memory HiLogger" (p. 40).

Handling the Instrument

DANGER

To avoid electric shock, do not remove the instrument's case. The internal components of the instrument carry high voltages and may become very hot during operation.

WARNING

Never modify the instrument. Only Hioki service engineers should disassemble or repair the instrument. Failure to observe these precautions may result in fire, electric shock, or injury.

CAUTION

To avoid damage to the instrument, protect it from physical shock when transporting and handling. Be especially careful to avoid physical shock from dropping.

NOTE

This instrument may cause interference if used in residential areas. Such use must be avoided unless the user takes special measures to reduce electromagnetic emissions to prevent interference to the reception of radio and television broadcasts.

Handling the Cables

CAUTION

- Avoid stepping on or pinching cables, which could damage the cable insulation.
- To avoid breaking the cables, do not bend or pull them.

NOTE

Use only the specified cables. Using a non-specified cable may result in incorrect measurements due to poor connection or other reasons.

Handling the CD

 CAUTION

- Always hold the disc by the edges, so as not to make fingerprints on the disc or scratch the printing.
 - Never touch the recorded side of the disc. Do not place the disc directly on anything hard.
 - Do not wet the disc with volatile alcohol or water, as there is a possibility of the label printing disappearing.
 - To write on the disc label surface, use a spirit-based felt pen. Do not use a ball-point pen or hard-tipped pen, because there is a danger of scratching the surface and corrupting the data. Do not use adhesive labels.
 - Do not expose the disc directly to the sun's rays, or keep it in conditions of high temperature or humidity, as there is a danger of warping, with consequent loss of data.
 - To remove dirt, dust, or fingerprints from the disc, wipe with a dry cloth, or use a CD cleaner. Always wipe radially from the inside to the outside, and do not wipe with circular movements. Never use abrasives or solvent cleaners.
 - Hioki shall not be held liable for any problems with a computer system that arises from the use of this CD, or for any problem related to the purchase of a Hioki product.
-

Overview

Chapter 1

1.1 Product Overview

The 8423 Memory HiLogger is a computer based data collection instrument. A combination of four types of unit can be connected to enable the measurement of up to 120 channels with one Memory HiLogger. Furthermore, the synchronous operation of a maximum of five Memory HiLoggers enables you to build a system with up to 600 channels. The instrument transfers the measurement data to the computer in real time. The instrument can also be used not just for computer based data collection but also as a standalone instrument. (Measurement with just this instrument is referred to as "standalone" within this manual.) In either case, set the measurement conditions with the supplied software Logger Utility. See "2.1 Installing Logger Utility" (p. 18).

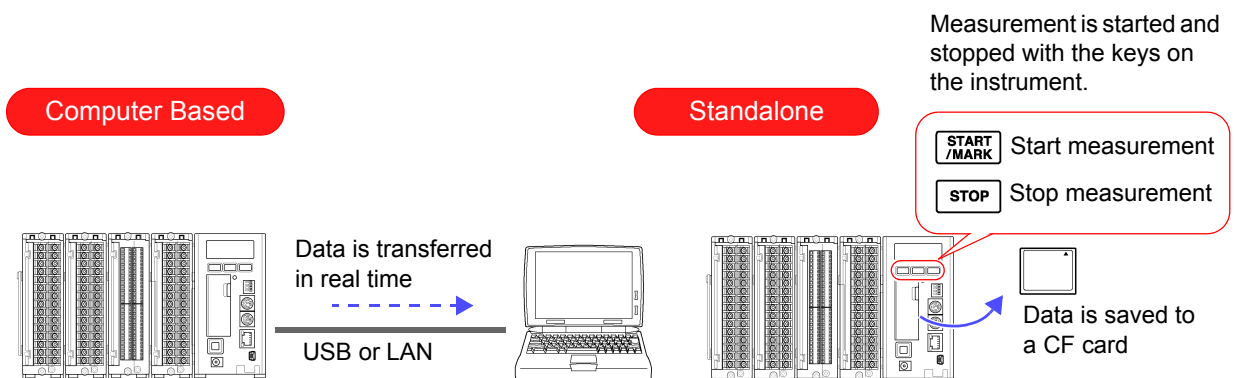

Example of Connecting Multiple Memory HiLoggers

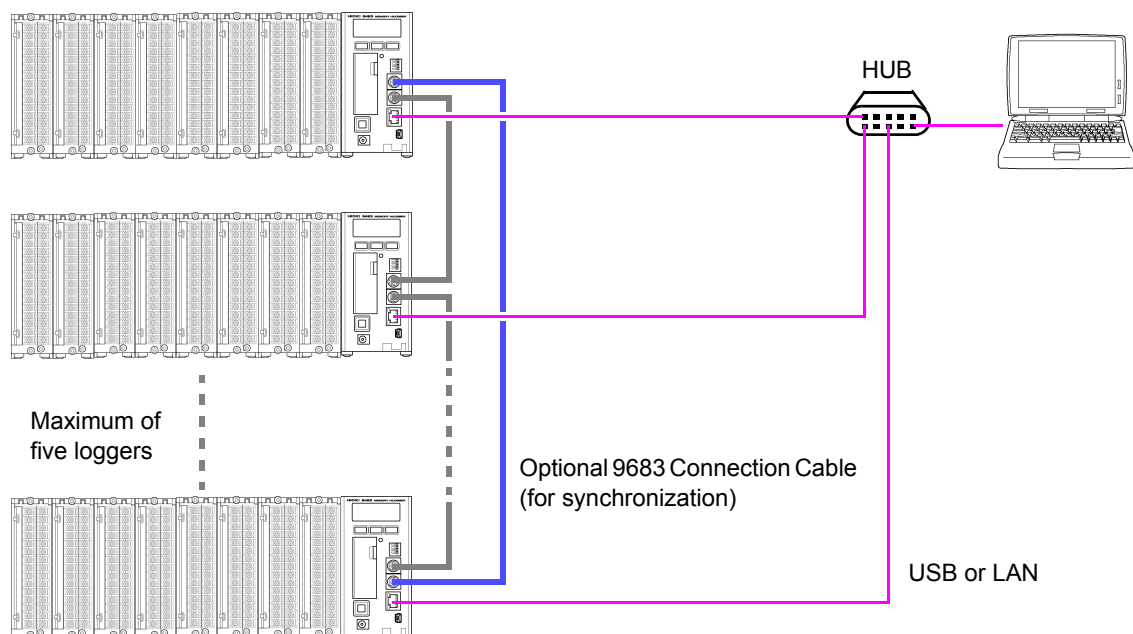

1.2 Features

◆ 10 ms Recording Intervals*

The fastest recording interval is 10 ms, during which the input data of all channels is scanned. The recording intervals can be set in 19 steps from 10 ms to 1 hour.

* The recording interval is 5 seconds or longer when one or more channels are set to humidity measurement.

◆ Multiple Channels (Up to 600 Channels)

A maximum of eight units can be connected to one 8423 Memory HiLogger to enable the measurement of up to 120 channels. Furthermore, the synchronous operation of five Memory HiLoggers facilitates the synchronized measurement of 600 channels.

◆ Isolated Input Circuits

The input circuits of all of the channels are isolated*. The maximum rated voltage to earth is 600 VAC/DC, so voltage can be measurement safely.

* 8948 Voltage/Temp Unit and 8949 Universal Unit only.

For the 8996 Digital/Pulse Unit, each 3 blocks of 5 channels are isolated within the unit.

◆ Dual Sampling

A combination of 2 types of recording interval can be set within the system. The recording intervals can be set individually by unit. Measuring with a recording interval suitable for each measurement object allows for efficient use of space in the internal memory or CF card.

See "5.3.1 Setting Function and Recording Interval" (p. 77).

◆ Flexible System Configuration

The following four types of unit can be used in accordance with the purpose of use. The input terminal block is removable to enable connections to be made easily.

- Model 8948 Voltage/Temp Unit and 8949 Universal Unit

There are 15 channel inputs per unit. Measurement is possible for voltage, nine types of thermocouple, two types of resistance temperature detector*, and humidity* (an optional sensor is required).

* Model 8949 Universal Unit only

- Model 8996 Digital/Pulse Unit

There are 15 channel inputs per unit. Logic input and pulse input can be set for each channel. Logic signal, totalization, and rotation rate measurement are possible.

- Model 8997 Alarm Unit

There are 15 channel outputs per unit. Alarm output (open collector output) allows for controlling external devices.

◆ Synchronized Measurement

Connecting multiple Memory HiLoggers with optional 9683 Connection Cable (for synchronization) allows for synchronized measurement. See "3.7 Connecting Synchronization Cables" (p. 48).

◆ Equipped with LAN & USB Interfaces

The instrument is compatible with LAN 100BASE-TX and USB2.0. A computer and Memory HiLogger can be connected to enable the supplied software Logger Utility to be used to control the Memory HiLogger and collect data.

◆ Equipped with CF Card Slot

This allows you to save the setting conditions and the measurement data in real time to a CF card. While data is being saved to the CF card in real time, you can replace the CF card without stopping measurement. Furthermore, the risk of files being damaged as a result of, for instance, an unexpected power outage is greatly reduced because internal backup circuitry is used to process the ending of files when there is a power outage.

◆ Equipped with External Control Input Terminals

The Memory HiLogger can be controlled by inputting a signal from an external device. This allows for the starting and stopping of measurement, external sampling, and external triggers.

◆ Standalone Measurement

After settings such as the measurement conditions have been configured from Logger Utility, you can disconnect the computer and then start/stop measurement with or on the instrument.

1.3 Names and Functions of Parts

Front Panel

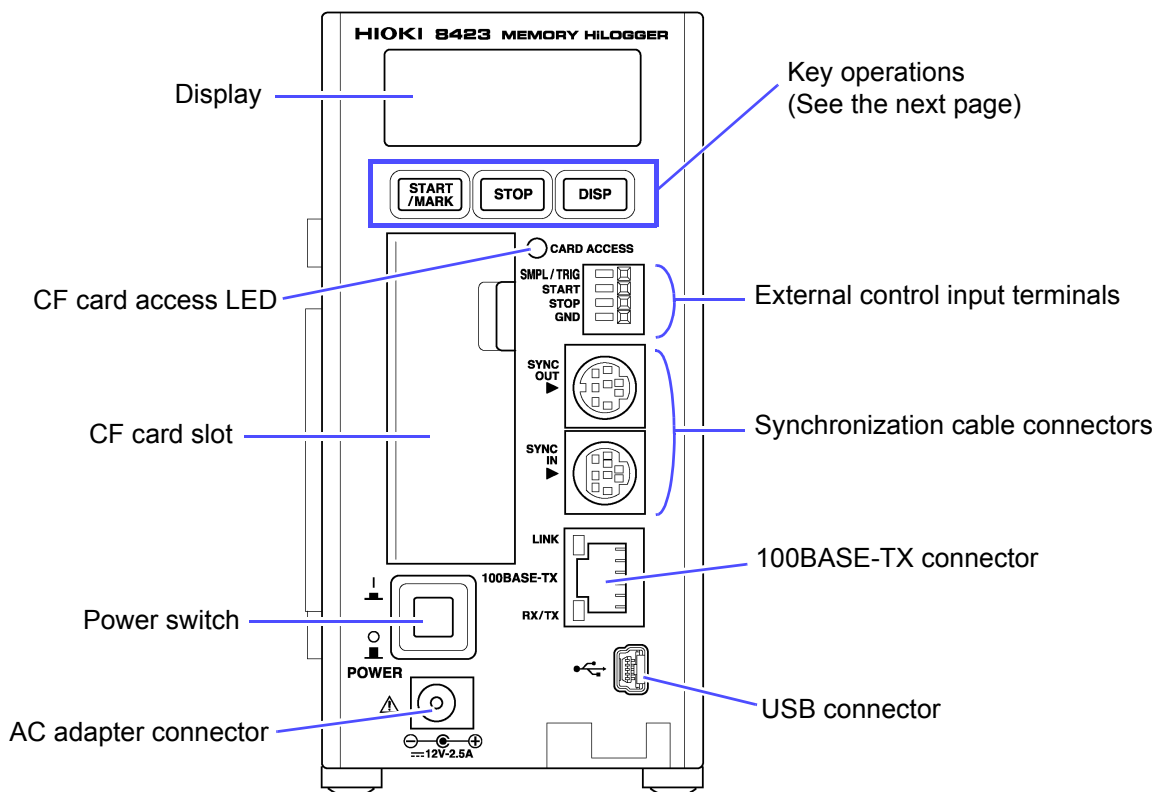

Names of Parts	Explanations
Display	Displays setting values, measurement values, error messages, warning messages, and other information.
CF card access LED	<ul style="list-style-type: none"> When the cover is open: <ul style="list-style-type: none"> Off: The CF card can be ejected. Lit red: The CF card cannot be ejected because data is being written. When the cover is closed: <ul style="list-style-type: none"> Off: A CF card is not inserted or recording is not possible because the CF card cannot be recognized. Lit green: A CF card is inserted and recording is possible. Lit red: The CF card is being read or written.
CF card slot	Allows for a CF card to be inserted for saving measurement data.
Power switch	Turns the power ON/OFF.
AC adapter connector	Allows for a 9418-15 AC Adapter to be connected.
USB connector	Allows for a USB cable to be connected.
100BASE-TX connector	Allows for a 9642 LAN Cable to be connected.
Synchronization cable connectors	Allows for connecting optional 9683 Connection Cable (for synchronization) when you want to perform synchronized measurement with multiple Memory HiLoggers.
External control input terminals	Allows for controlling the instrument by inputting a signal from an external device.

Key Operations

Keys	Explanations
START / MARK	<ul style="list-style-type: none"> The key lights during measurement. Press the key once during standby to start measurement. Press the key during measurement to input an event mark. <p>When the power is on: You can initialize the settings by turning the power on while pressing START / MARK and STOP.</p> <p>See "13.3 Initializing Settings (System Reset)" (p. 233).</p>
STOP	<ul style="list-style-type: none"> Press the key twice in succession during measurement to stop measurement. <p>When the power is on: You can initialize the settings by turning the power on while pressing STOP.</p> <p>See "13.3 Initializing Settings (System Reset)" (p. 233).</p>
DISP	<ul style="list-style-type: none"> Switches the display content. The key flashes while an error message or warning message is displayed. Press the key once to clear the display. If the key is pressed for at least one second and then released while measurement values are displayed during measurement, the display channels are fixed to those displayed the instant the key was released. Press the key for at least one second again to cancel fixing of the display channels. <p>When the power is on: The instrument enters setting mode if you turn on the power while pressing DISP.</p> <p>See "Chapter 10 Setting Method for Logger" (p. 185).</p>

Rear Panel

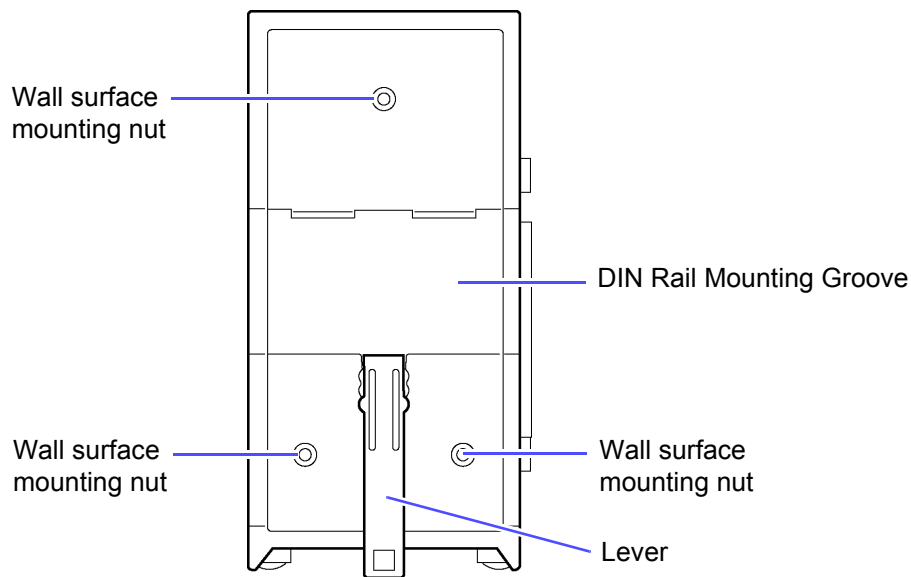

Upper/Bottom Panel

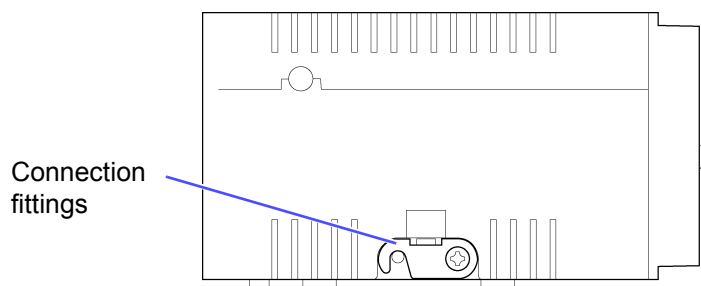

Left Panel

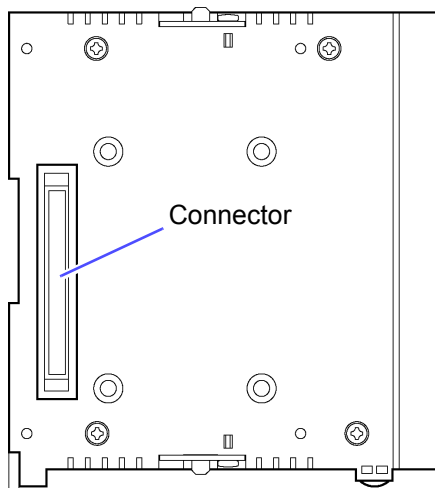

Right Panel

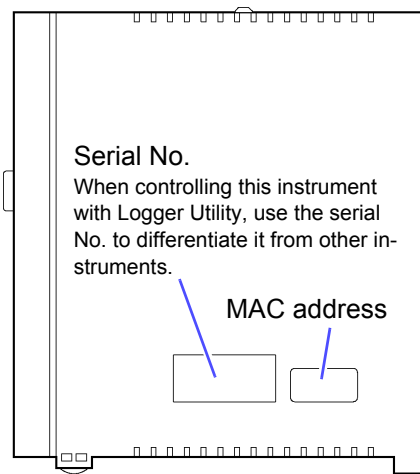
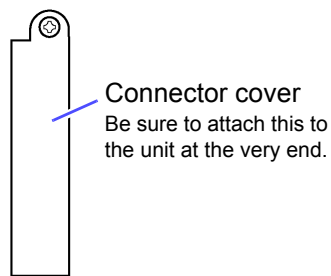

1.4 System Configuration

The system configuration is as follows.

Connection Example:

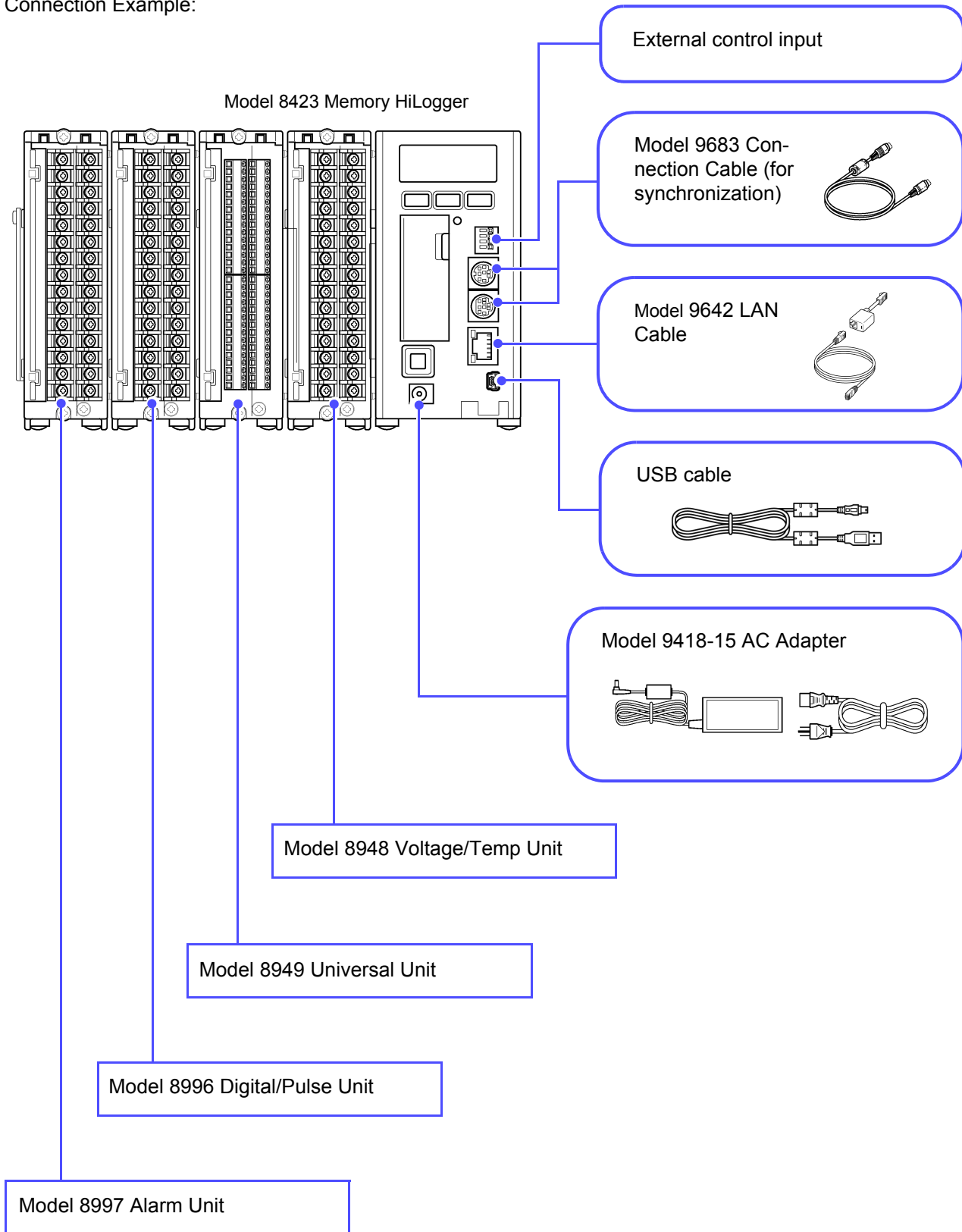

1.5 Measurement Flowchart

Proceed with measurement while referring to the following measurement flowchart.

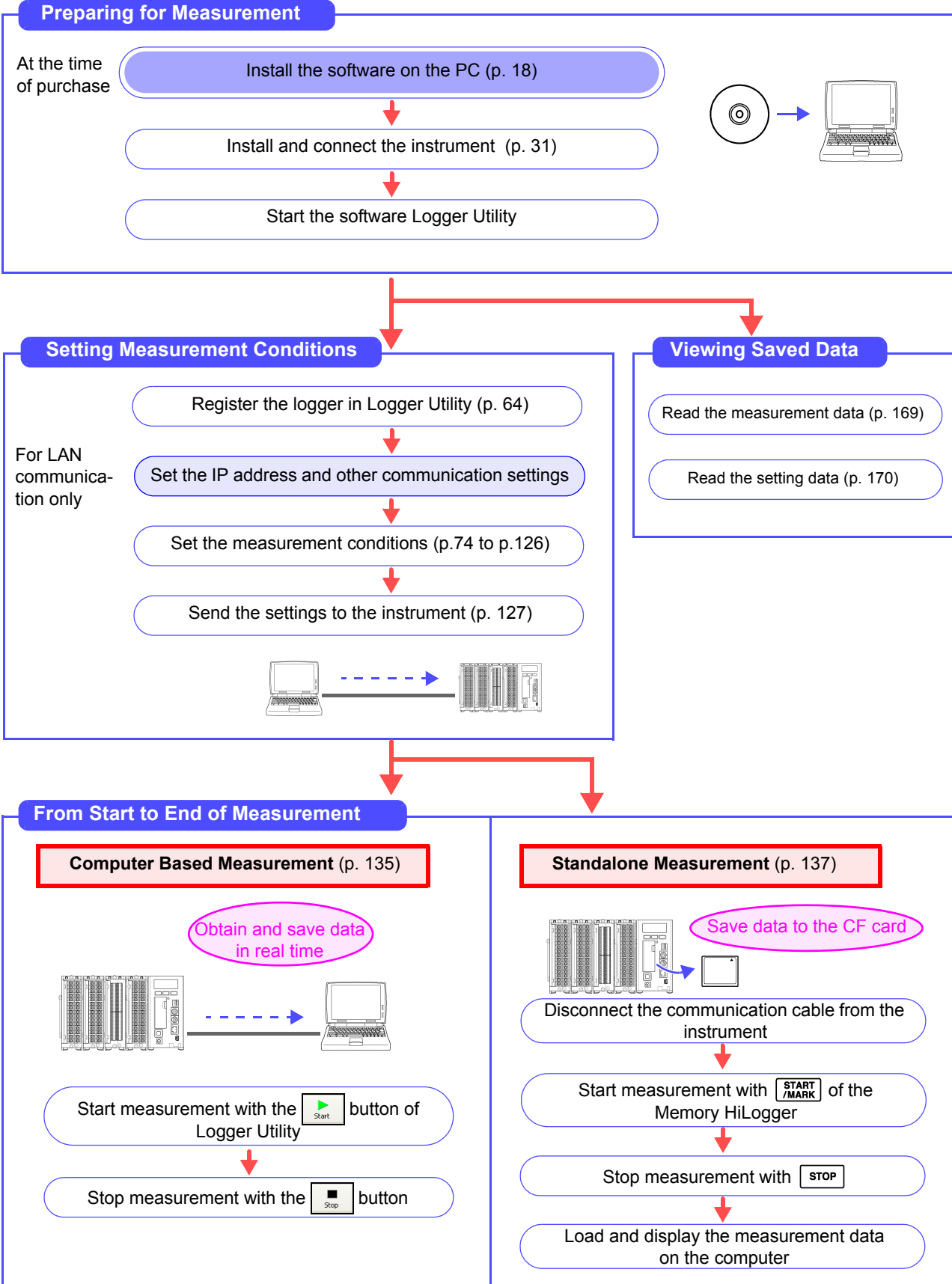

Installing the Software

Chapter 2

2

Install the supplied software Logger Utility on the computer the first time you use the instrument after purchase. Before starting the installation, check the operating environment.

Installation Procedure

(1) Set the CD into the drive of the computer



(2) Install Logger Utility (p. 18)



(3) Install the USB driver (p. 21)



(4) Connect the AC adapter to the instrument and turn on the power



(5) Connect the instrument and computer with the USB cable



Supplied CD

Operating Environment

OS	: Windows 2000 (with SP4 or later) Windows XP (with SP2 or later) Windows Vista Windows 7
CPU	: Pentium III (500 MHz) or better
Monitor Resolution	: 1024 x 768 dots or better
Internet Explorer	: 6.0 or better
Memory	: At least 512 MB
Interface	: Ethernet or USB

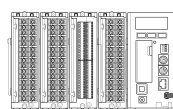

USB cable



Mouse Operation

Click	Press and quickly release the left button of the mouse.
Right-click	Press and quickly release the right button of the mouse.
Double click	Quickly click the left button of the mouse twice.
Drag	While holding down the left button of the mouse, move the mouse and then release the left button to deposit the chosen item in the desired position.
Activate	Click on a window on the screen to activate that window.

Notation

[]	Menus, pages, setting items, dialogs, buttons in a dialog, and other names on the screen and the keys are indicated in brackets.
CURSOR (Bold characters)	Bold characters within the text indicate operating key labels.
Windows	Unless otherwise specified, "Windows" represents Windows 2000, Windows XP, Windows Vista or Windows 7.
Dialog	Dialog box represents a Windows dialog box.

2.1 Installing Logger Utility

Follow the procedure below to install Logger Utility. This explanation is for installing the software on Windows XP. The messages displayed may differ slightly depending on other operation system or settings you are using.

Important

If you are running software such as antivirus software, be sure to end the software before you start the installation. The installation may not be performed properly if antivirus software is running.

- 1. Start up Windows.**
Exit all running applications.
- 2. Insert the included CD into the computer's CD-ROM drive, the installer run automatically.**
If the installer do not start, execute "Setup.exe" from the CD-ROM drive.
In Vista, Although the dialog which ask for installation permission of application, click **[Allow]**.

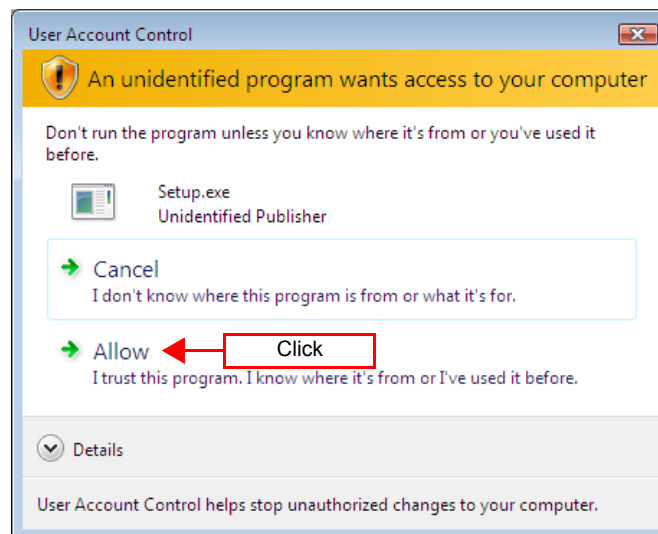

3. Click the **[Next]** button of the installer, then read and agree with the contents in the License Agreement before clicking the **[Next]** button.

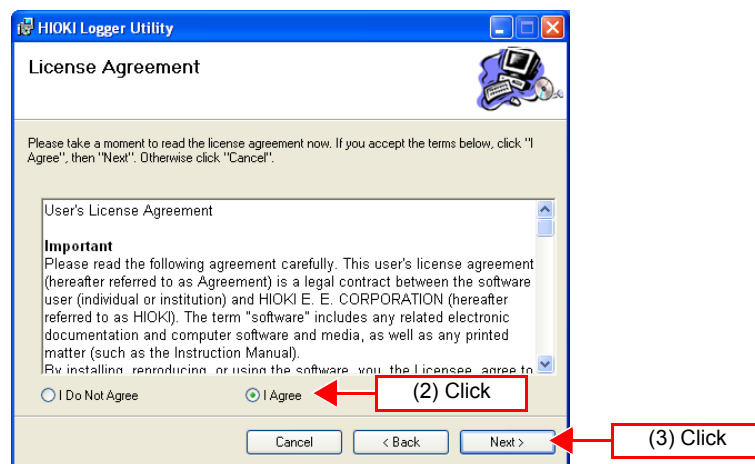
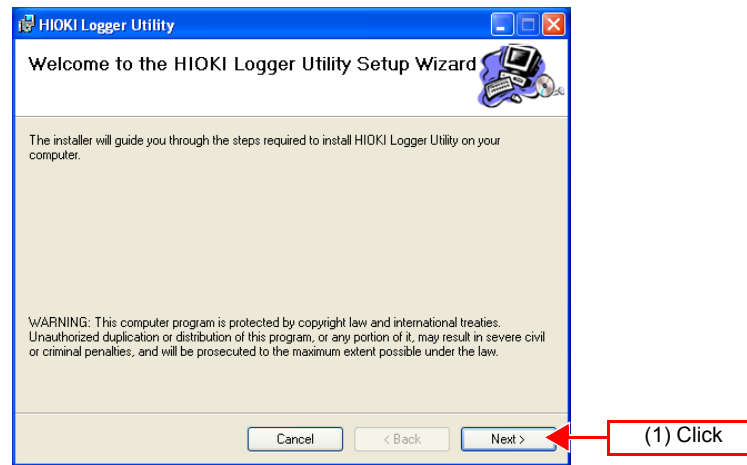

4. Click **[Everyone]** before clicking the **[Next]** button.

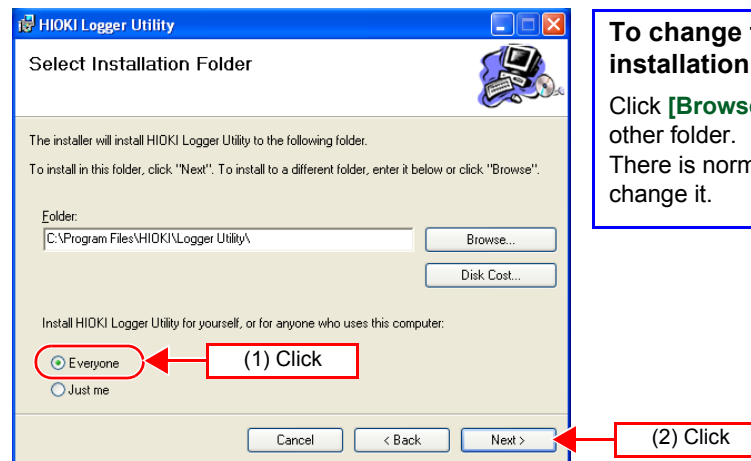

To change the installation destination

Click **[Browse]** to select another folder.
There is normally no need to change it.

5. Click **[Next]** to start installing.

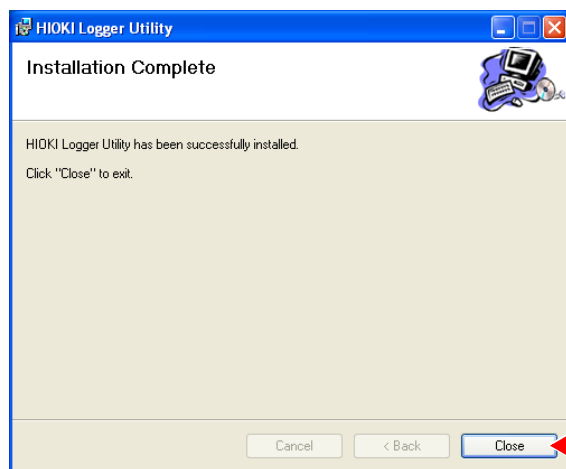
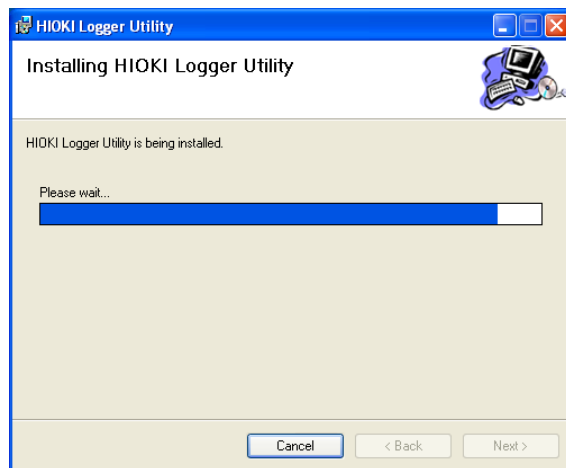
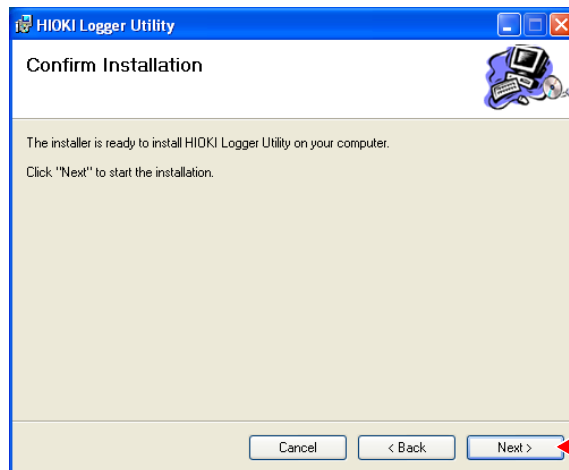

Installation finished

2.2 Installing the USB Driver

Install the USB driver before you use the instrument with a USB connection.

1. Install the driver.

Run **[SetupDriver32.msi]** in the CD-R.

If [Logger Utility] is already installed, run the CD from the following location.

[c:\Program Files\HIOKI\LoggerUtility\Driver\SetupDriver32.msi]

If you are using the Windows Vista/7 64bit version:

[c:\Program Files(x86)\HIOKI\LoggerUtility\Driver\SetupDriver64.msi]

Run **[SetupDriver64.msi]** in the CD-R.

If [Logger Utility] is already installed, run the CD from the following location.

[c:\Program Files\HIOKI\LoggerUtility\Driver\SetupDriver64.msi]



Depending on the environment, the dialog box may take some time to appear so please wait till it does so.

2. Click [Next].

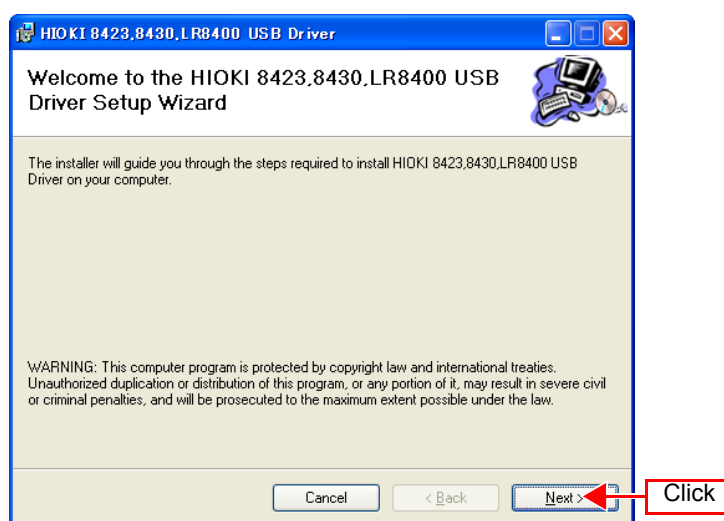

2.2 Installing the USB Driver

3. Check [Everyone] and click [Next].

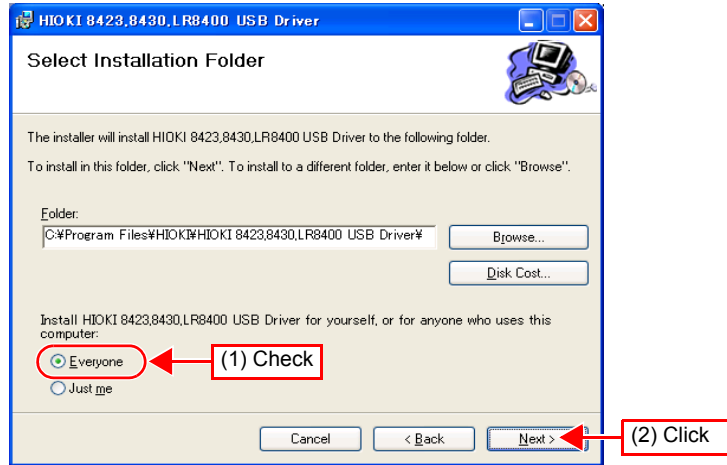

NOTE When you want to change the installation destination, click [Browse...] to change the folder to install into. Normally, there is no need to change.

4. Click [Next] to start installing.

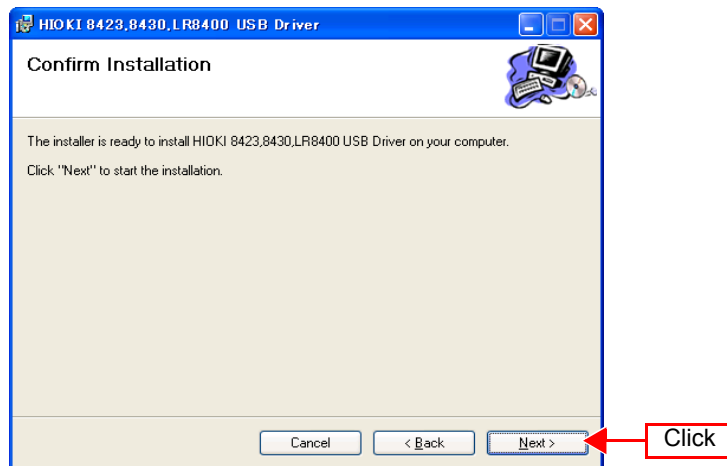

Installing.

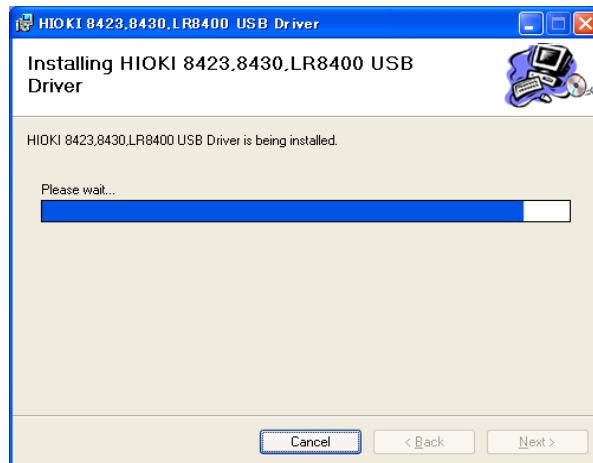

For WindowsXP

During the installation, a message saying that the software has not passed Windows Logo testing will appear a few times, click [Continue Anyway] to continue installing.

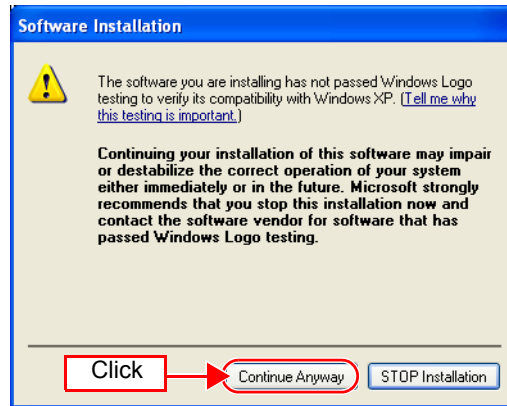

For Windows Vista/7

When a dialog box requesting your permission to continue the program appears, click [Continue].

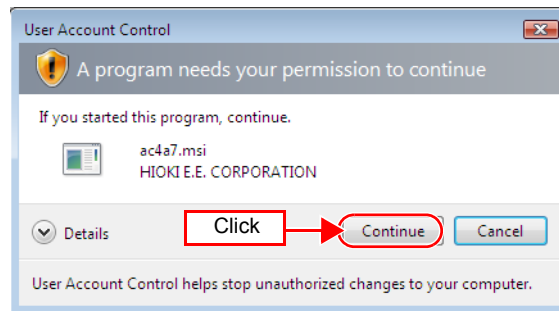

Sometimes another dialog box requesting your permission to install the software may appear. When it does, check [Always trust software from "HIOKI E.E. CORPORATION"] and click [Install] to continue.

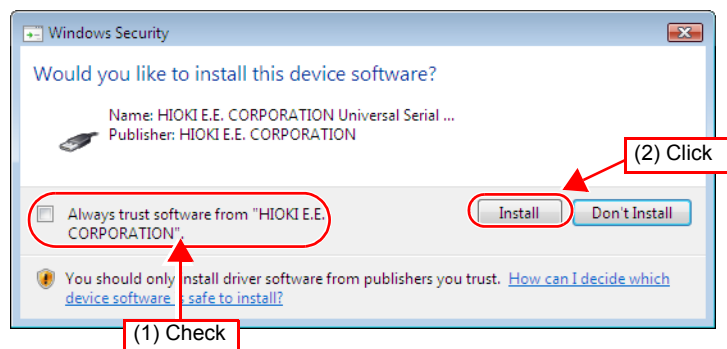

5. When installation is completed and the dialog box appears, click **[Close]** to exit.

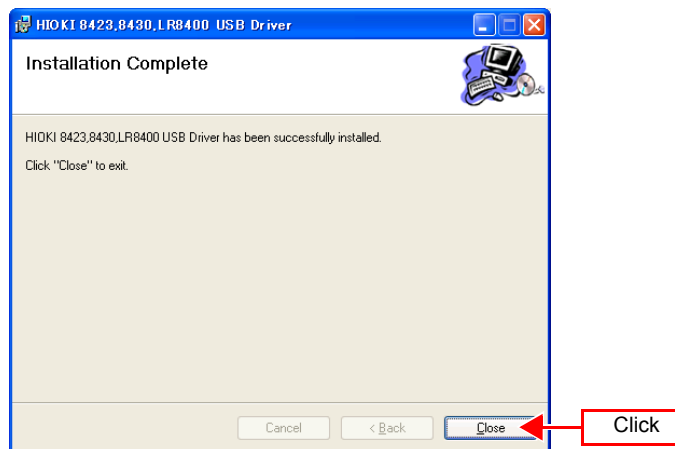

This completes the driver installation.

2.3 Connect the instrument and computer with the USB cable provided

Please connect the instrument after installing the USB driver.



Do not plug in or unplug the USB cable while the instrument is operating.

For Windows 2000/Vista/7

1. Connect the AC adapter to the instrument and switch on the power.
2. Connect the instrument and computer with the USB cable provided. The HiLogger is automatically recognized, and preparations to use the device are complete.

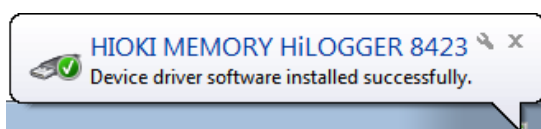

For Windows XP

1. Connect the AC adapter to the instrument and switch on the power.
2. Connect the instrument and computer with the USB cable provided. A [Found New Hardware Wizard] dialog box will appear and the new hardware detection wizard will begin.
3. Check [No, not this time] and click [Next].



2.3 Connect the instrument and computer with the USB cable provided

4. Check [Install the software automatically (Recommended)] and click [Next].

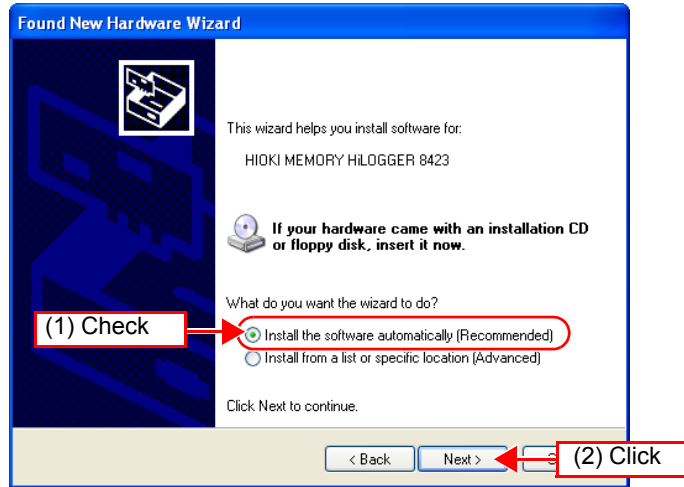

Please wait while the driver is being installed.

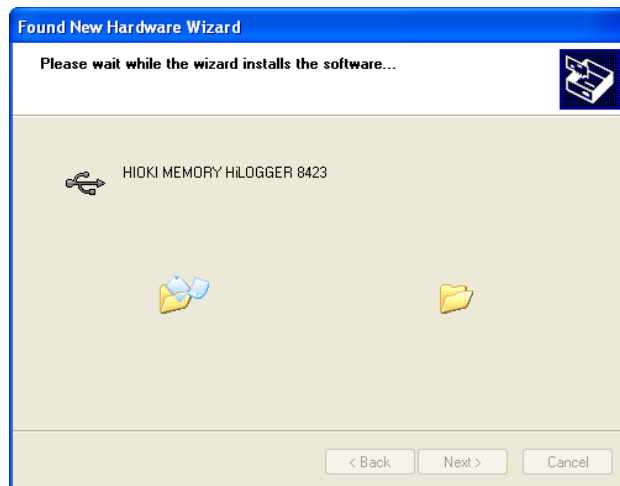

5. A message saying that the software has not passed Windows Logo testing will appear a few times, click [Continue Anyway] to continue installing.

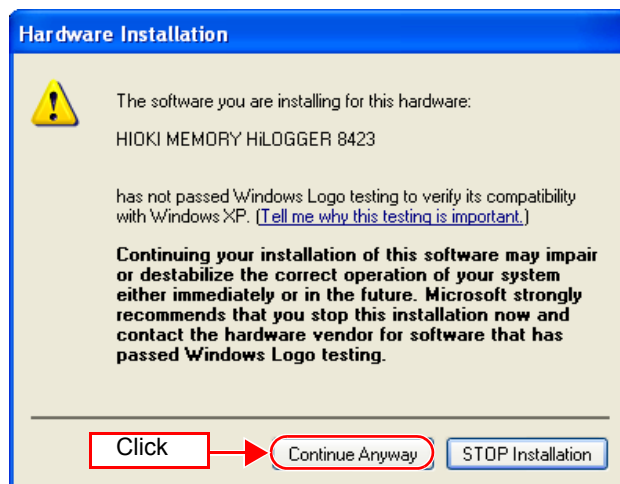

2.3 Connect the instrument and computer with the USB cable provided

6. When installation is completed and the dialog box appears, click **[Finish]** to exit.

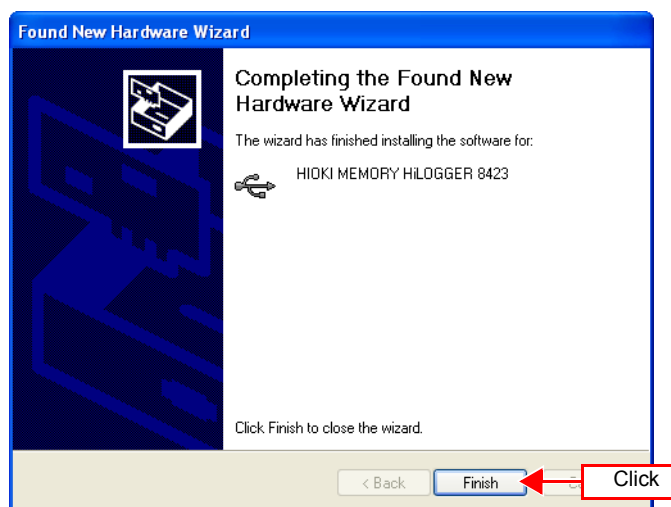

This completes the driver installation.

2.4 Starting and Ending Logger Utility

Starting Logger Utility

From the Start Menu of Windows, click **[All Programs] - [HIOKI] - [Logger Utility] - [Logger Utility]**.

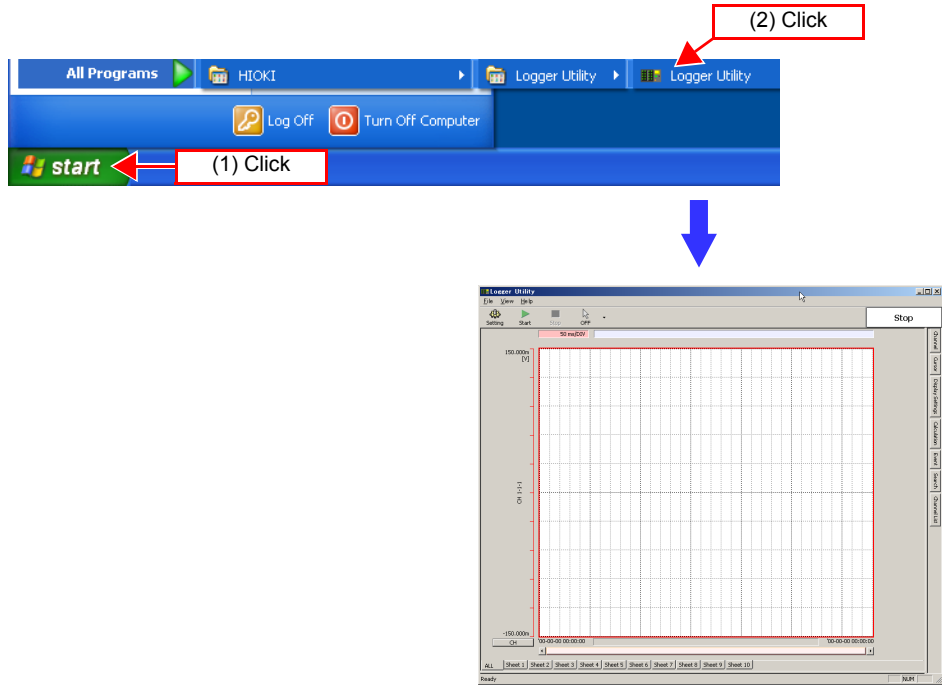

Logger Utility starts with the settings in the same state as when the software was last ended. When you want to initialize the settings, click **[Initialize All Settings]** from the File menu.

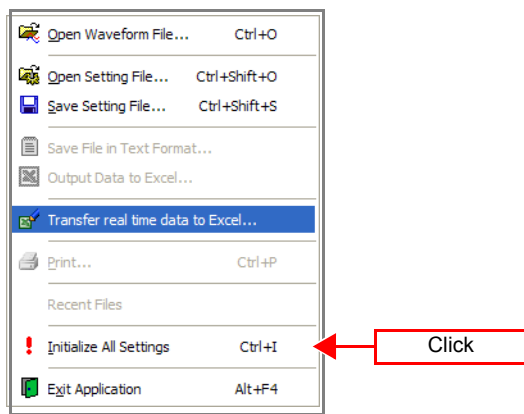

Ending Logger Utility

Click **[Exit Application]** from the File menu of the main screen.

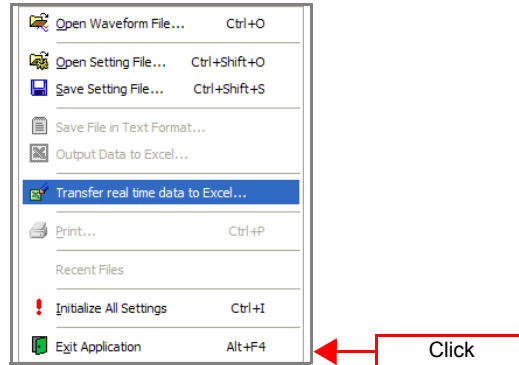

Alternatively, you can click the **[x]** close button at the top right of the main screen.

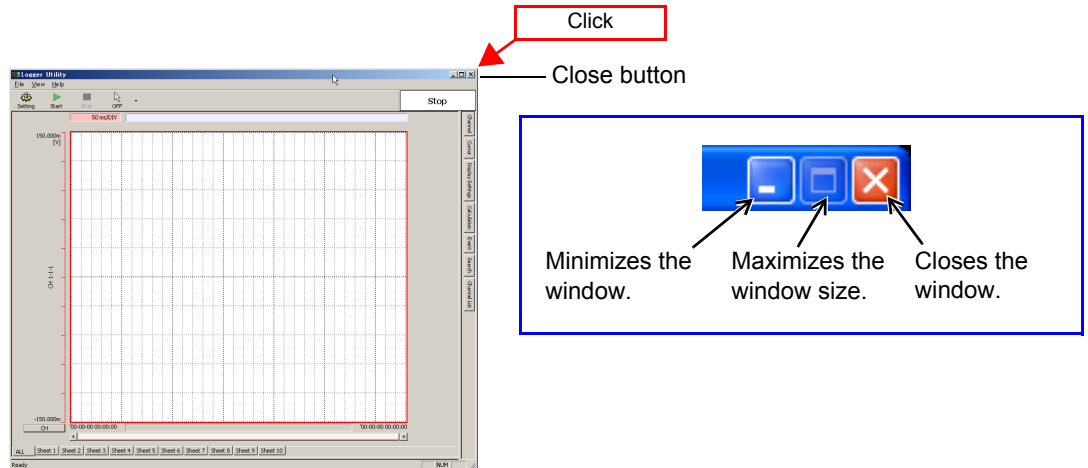

2.5 Uninstalling the Logger Utility

Use the following procedure to uninstall the program.

1. From the Windows Start menu, select the **[Control Panel]**, and double click **[Add or Remove Programs]**.



The **[Add or Remove Programs]** screen appears.

2. From the list of installed programs, select **[HIOKI Logger Utility]**, and remove it.

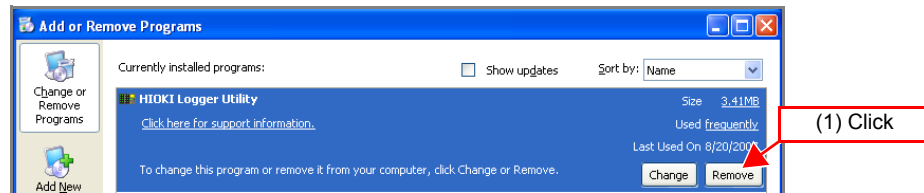

A confirmation dialog appears when you click **[Remove]**.

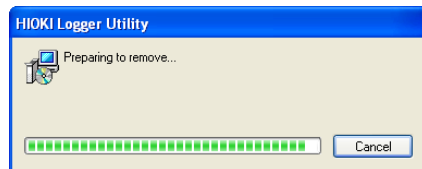
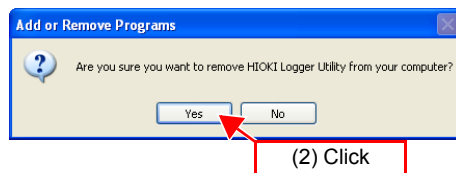

The uninstall process begins. The uninstall progress status is displayed.

Uninstall is finished

You are returned to the **[Add or Remove Programs]** screen. Settings files are not deleted during uninstall, so if no longer needed, delete them manually.

Setting Up the Instrument

Chapter 3

This section describes preparations for starting measurement.

NOTE

Before connecting the instrument to a computer or network, install Logger Utility while referring to "Chapter 2 Installing the Software" (p. 17).

Installation and Connection Procedure

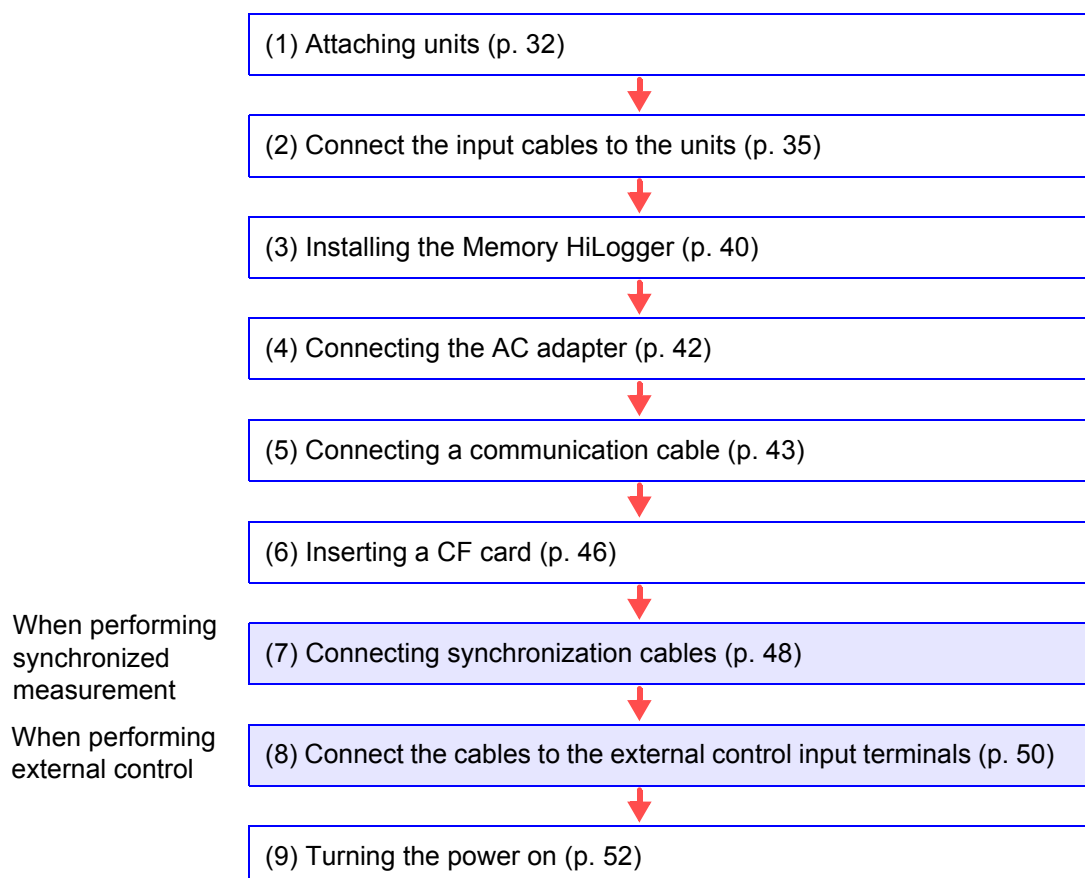

3.1 Attaching Units

You can attach optional units to the instrument in accordance with the measurement object. A maximum of eight units (total of 120 channels) can be connected to one instrument.

3.1.1 Unit Types

The following four types of unit are available. Select a unit in accordance with the measuring object. For detailed specifications of the units, see "12.3 Unit Specification" (p. 221).

Unit List

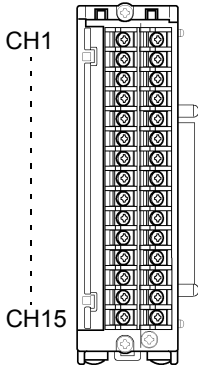
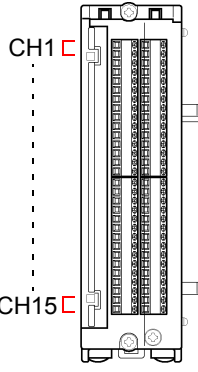
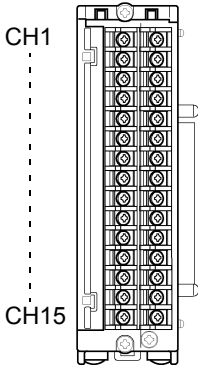
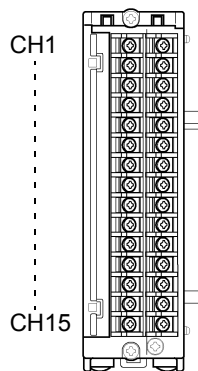
Model 8948 Voltage/Temp Unit	Model 8949 Universal Unit
<p>This unit is capable of measuring voltage and temperature.</p>  <p>Measurement object</p> <ul style="list-style-type: none"> • Voltage • Temperature (Thermocouple) <p>M3 screw terminal block</p> <p>15 input channels</p>	<p>This unit is capable of measuring voltage, temperature, and humidity.</p>  <p>Measurement object</p> <ul style="list-style-type: none"> • Voltage • Temperature (Thermocouple/resistance temperature detector) • Humidity (use the 9701 Humidity Sensor) <p>Push-type terminal block</p> <p>15 input channels</p>
Model 8996 Digital/Pulse Unit	Model 8997 Alarm Unit
<p>This unit is capable of measuring pulse signals and logic signals. It allows you to totalize the number of pulses of, for instance, an integrating wattmeter or flowmeter, and count the number of pulses of, for instance, a rotation meter to obtain the rotation rate.</p>  <p>Measurement object</p> <ul style="list-style-type: none"> • Logic signal • Pulse signal • Rotation rate <p>M3 screw terminal block</p> <p>15 input channels</p>	<p>This unit outputs an alarm when the measurement value satisfies the set alarm condition (output format: open collector). This enables control of an external device in accordance with an alarm.</p>  <p>Alarm output function</p> <p>M3 screw terminal block</p> <p>15 output channels</p>

3.1.2 Attaching a Unit

This section describes attaching a unit to the instrument. Units are coupled together with connectors on the left and right sides.

! WARNING

- To avoid electric shock accident, before removing or replacing a unit, confirm that the instrument is turned off and that the cables are disconnected.
- If the units are not securely attached with the connection fittings, the specifications may not be satisfied, resulting in a malfunction.
- Failure to fasten the connectors properly may result in sub-specification performance or damage to the equipment
- Be sure to attach the supplied connector cover to the unit at the very end.

NOTE

Up to eight units can be connected to the instrument. If nine or more units are connected, measurement will not be possible.

Required tools: Phillips screwdriver 1

- 1. Turn off the power of the unit.**
Disconnect any connected cables.
- 2. Attach the unit to the 8423 Memory HiLogger.** To attach multiple units, repeat the same procedure.

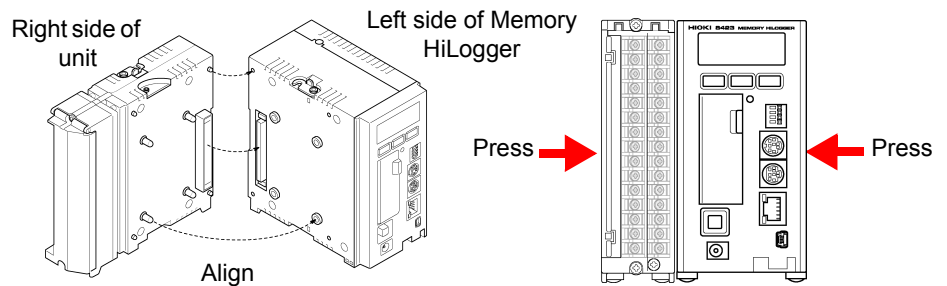

- 3. Secure the unit in place with the connection fittings at the top and bottom of the unit.**
Use the Phillips screwdriver to tighten the screws to no more than 0.6 Nm.

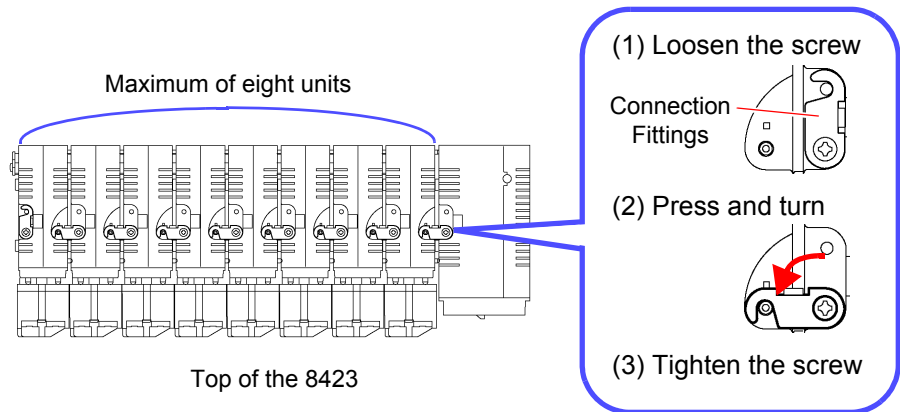

- 4.** Attach the supplied connector cover to the unit on the very left side when looking from the front. Insert the protruding part of the connector cover into the connector opening of the unit, close the cover, and then secure it in place with the screw. Tighten the screw to no more than 0.6 Nm.

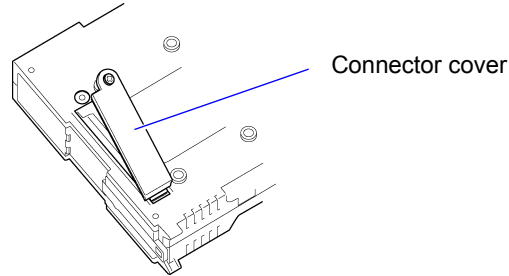

- 5.** Pull down the levers on the rear of the instrument and unit, and hook the connection plate on to the hooks at the top of the DIN rail mounting groove.

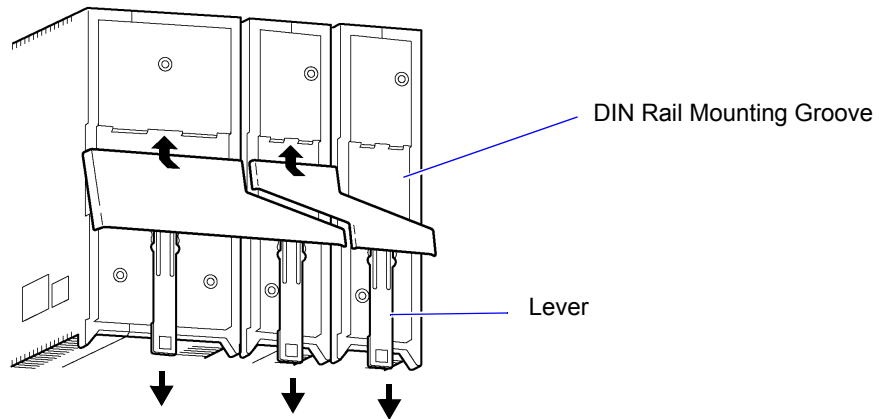

- 6.** Push up the levers until they click into place.

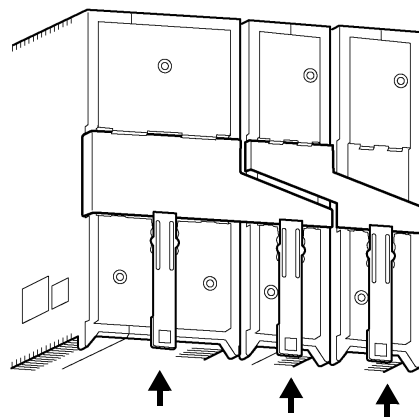

NOTE

- When you remove the connection plate from the instrument, perform the attachment procedure in the reverse order.
- When you secure the instrument to a wall surface or DIN rail, the connection plate does not need to be attached.

3.2 Connecting a Cable to the Terminal Block

Connect cables to the terminal block of a unit in accordance with the purpose of use.

3.2.1 Removing and Attaching a Terminal Block

A terminal block can be removed to enable the cable to be easily connected. (You can also connect the cable while the terminal block is attached.)

! WARNING

To avoid an electric shock or short-circuit accident:

- Turn off the power of the instrument before removing and attaching the terminal block.
- Never attach or remove the terminal block while the power of a measurement object to which a cable is connected is on.

- 1. Turn off the power of the unit.**
Disconnect any connected cables.
- 2. Loosen the screws at the top and bottom of the unit with the Phillips screwdriver, and pull the front to remove the terminal block.**

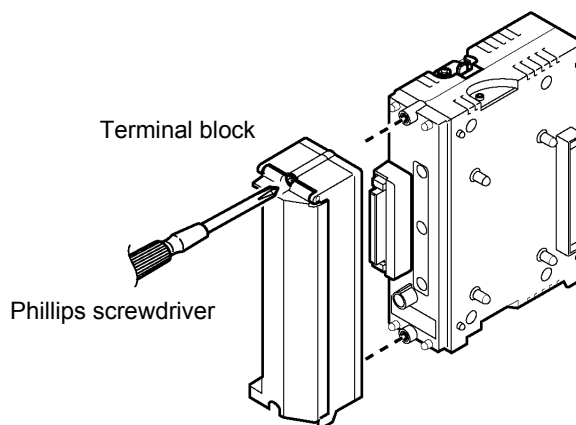

- 3. Connect the cable, and then attach the terminal block by performing the procedure up to now in the reverse order.**
Tighten the screws to no more than 0.6 Nm.

3.2 Connecting a Cable to the Terminal Block

NOTE

- Be sure to attach the removed terminal block to the unit to which it was originally attached.
- Since the structure of a terminal block is designed so that it cannot be attached to a unit of a different type, using excessive force to try to attach a terminal block to the wrong unit will damage the connector.



When you want to mark a terminal block and unit:

Use the mark area on the front of the unit for writing a number, comment, or other information. If you use a pencil, you can erase the writing by just gently wiping it off. It is convenient to mark the removed terminal blocks and the units to help you remember which block to attach to which unit.

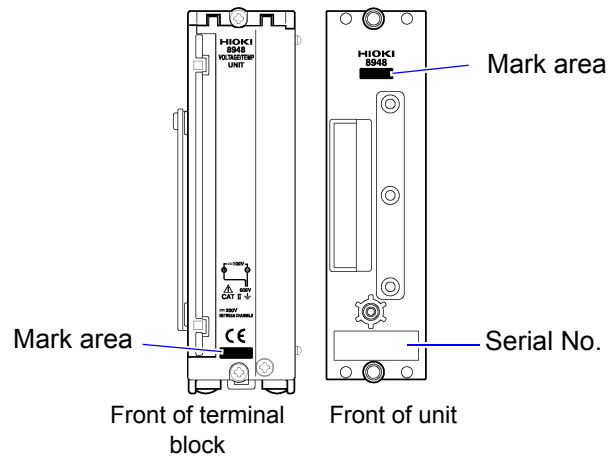

3.2.2 Connecting a Cable

To connect a cable to a terminal block, lift up the cover at the front and then connect the cable to the terminal block.

! WARNING

- In order to prevent electric shock and short-circuit accidents, shut off the power to the line to be measured before connecting the input cable.
- To avoid electrical accidents, confirm that all connections are secure. The increased resistance of loose connections can lead to overheating and fire.
- Channels are isolated by semiconductor relays. Never apply a voltage in excess of the specifications between channels as doing so could damage the semiconductor relays by causing them to short out. Exercise particular care concerning surge protection against lightning and other threats. If the instrument yields erroneous measured values, have it inspected.

! CAUTION

Be sure to pull out an input cable after you loosen the screws of the terminal block. The input cable will be damaged if the screws are not loosened and excessive force is used to pull out the input cable.

1. **Loosen the screw at the bottom of the cover with the Phillips screwdriver and lift up the cover.**

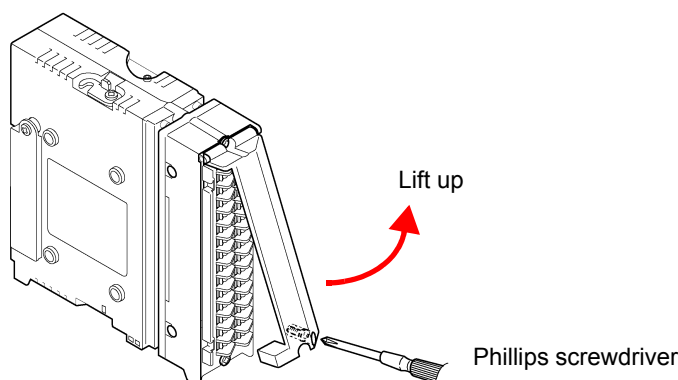

2. **Loosen the screws of the terminal block, connect the input cable, and then tighten the screws.**

The connection method differs depending on the measurement object. See the next page.

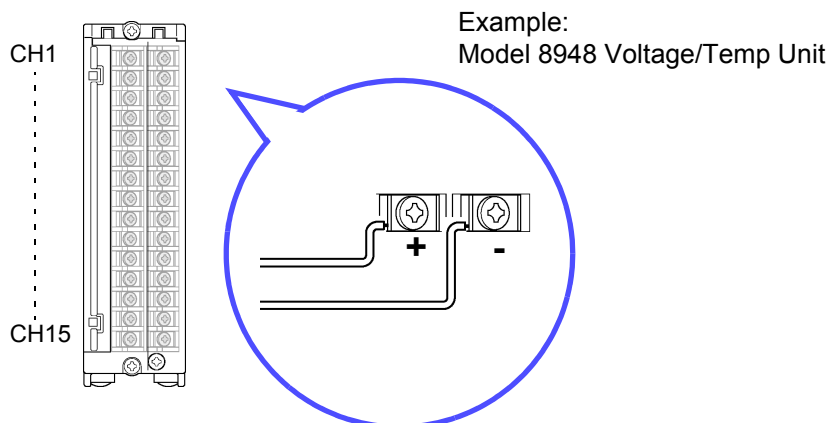

3. **Reattach the cover, and tighten the screw.**
Tighten the screw to no more than 0.6 Nm.

3.2 Connecting a Cable to the Terminal Block

Voltage Measurement and Temperature Measurement with Thermocouple

Model 8948 Voltage/Temp Unit

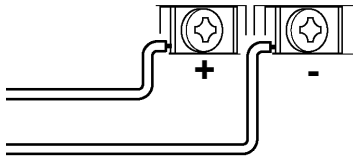

Model 8949 Universal Unit

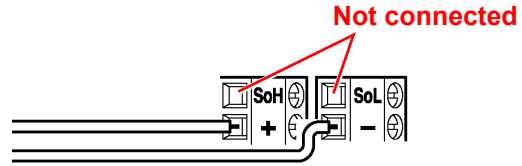

4-20 mA Input

Model 8948 Voltage/Temp Unit

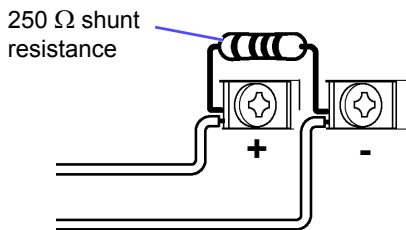

Model 8949 Universal Unit

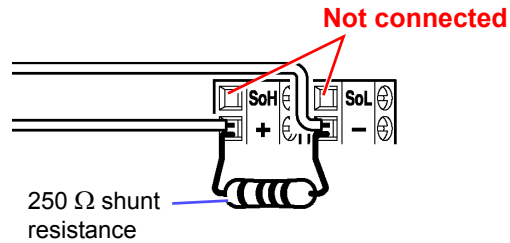

Humidity Measurement

Model 8949 Universal Unit

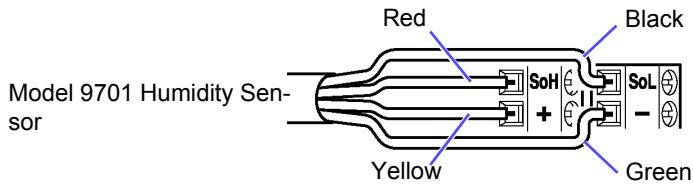

Temperature Measurement with Resistance Temperature Detector

(3-wire)

Model 8949 Universal Unit

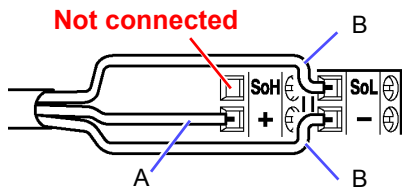

(4-wire)

Model 8949 Universal Unit

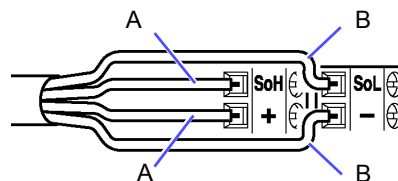

Logic Signal, Pulse, and Rotation Rate Measurement

Model 8996 Digital/Pulse Unit

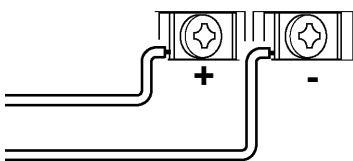

Alarm Output

Model 8997 Alarm Unit

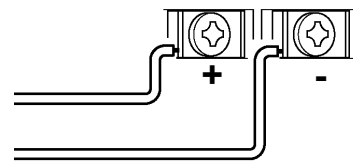

See For more information about individual units' circuit architecture, see the circuit schematic for the unit in question. (p. 133)

3.2 Connecting a Cable to the Terminal Block

NOTE

- If an input cable of 3 m or longer is connected, measurement may be affected by external noise and other electromagnetic interference.
- The general guidelines for resistance temperature detector terminations are provided in JIS Z 8704, in which A and B signals are designated by red and white wires, respectively. However, the three-wire IEC guidelines define the connections differently (red and white are reversed), so special attention is required.
- The measurement current for a resistance temperature detector is 1 mA.
- Connect the cable while it is disconnected from the power line and ground wire.
- Be sure to close the terminal block cover, and tighten the screw.
- If the cable is connected in parallel with another device, there may be variations in the measurement values. When connecting in parallel, confirm operation before use.
- In the case of the SoL terminal (8949 Universal Unit only) for connecting a resistance temperature detector or 9701 Humidity Sensor, all channels are common internally and not insulated.
- Make sure the ambient temperature around the terminal block does not change. In particular, make sure there is no ventilation fan, air conditioner, or the like blowing air directly onto the terminal block.
- When using crimp-type terminals for connecting to the terminal block of the 8948 Voltage/Temp Unit, 8996 Digital/Pulse Unit, or 8997 Alarm Unit, use terminals with insulating coating that are for M3 screws and of the size shown in the figure below.

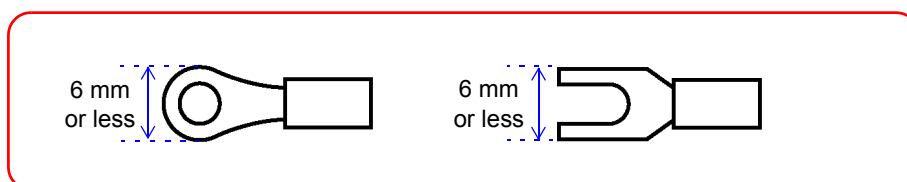

- The following cable is recommended for connecting to the terminal block of the 8949 Universal Unit.

Single strand: 0.14 to 1.5 mm²

Multi-strand: 0.14 to 1.0 mm²

AWS: AWG26 to AWG16

Standard insulation stripping length: 5 mm

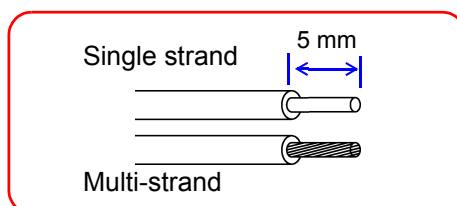

- The waveform for an open channel may sometimes appear to be influenced by the signals of the other channels being measured. If you do not like this, please set the waveform display of the open channel to OFF or short-circuit the input terminals of the open channel by connecting the positive and negative terminal.

3.3 Installing the Memory HiLogger

The following three installation methods are possible.

(1) Place on a flat surface

(2) Mount to a DIN rail

(3) Mount to a wall surface with screws

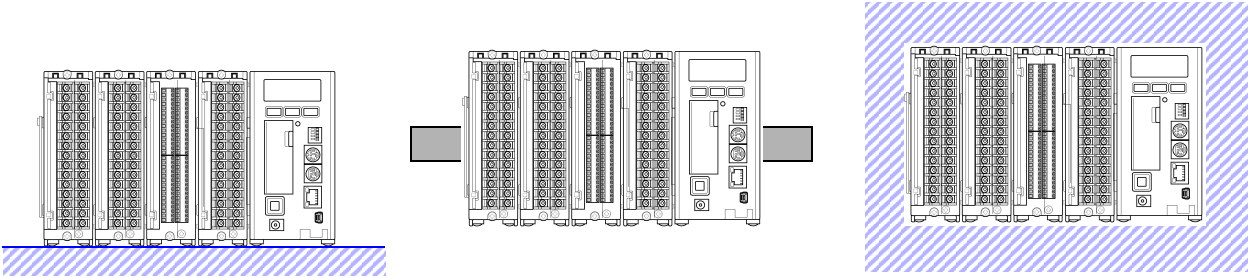

3.3.1 Mounting to a Wall Surface with Screws

When mounting to a wall surface, use screws to secure the instrument. Secure it to a wall surface of sufficient strength.

1. Turn off the power of the unit. Disconnect any connected cables.
2. Refer to the figure below and create mounting holes in the wall surface.

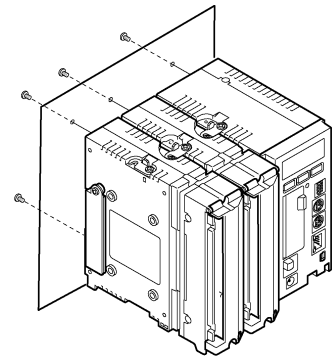
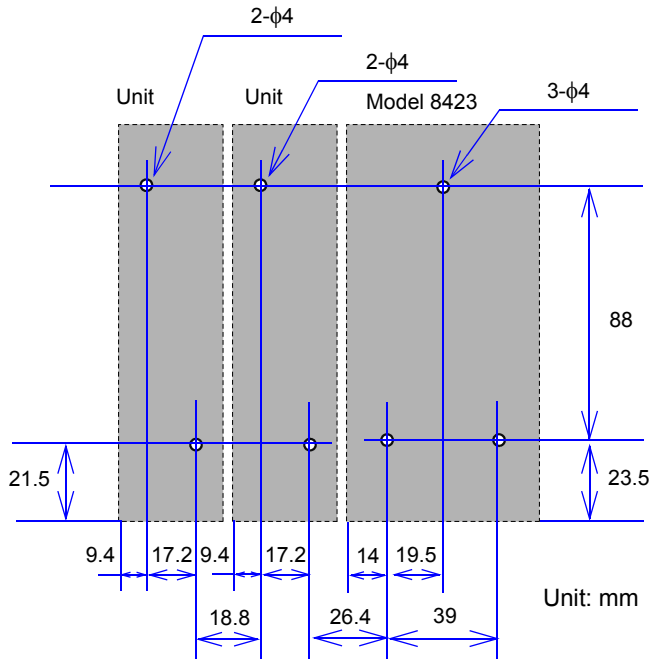

3. Insert the screws from the back side of the wall surface and secure the instrument with the nuts on the rear of the instrument. Use M3 screws of a length equivalent to the thickness of the board plus no more than 5 mm. Tighten the screws to no more than 0.6 Nm.

3.3.2 Securing with a DIN Rail

You can use the DIN rail mounting groove on the rear of the instrument to secure the instrument to a 35 mm wide DIN rail.

CAUTION

To avoid damage to the instrument as a result of it falling, do not apply excessive force on the instrument from above.

1. **Secure the DIN rail to a wall or other surface.**
2. **Turn off the power of the unit.**
Disconnect any connected cables.
3. **Pull up the levers on the rear of the instrument and unit.**

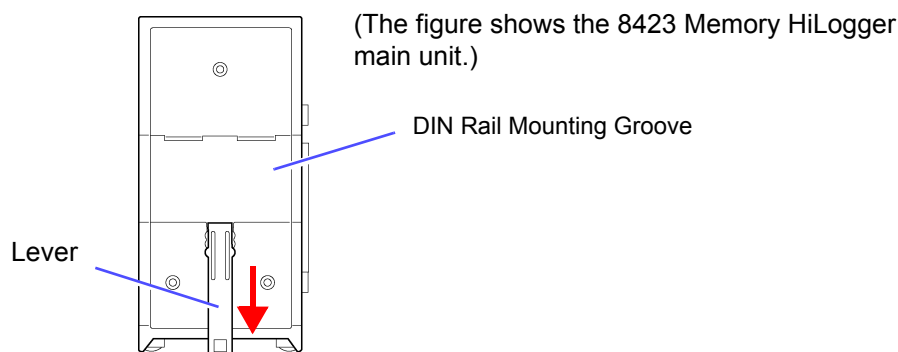

4. **Hook the hooks at the top of the DIN rail mounting groove on to the DIN rail and push in the bottom.**

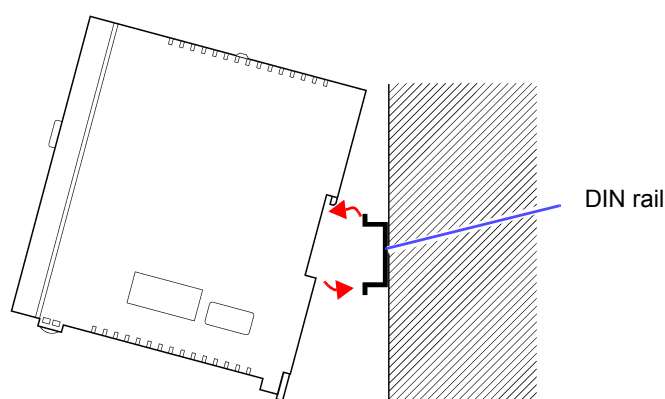

5. **Push up the levers until they click into place.**
When you want to unmount the instrument from the DIN rail, perform the mounting procedure in the reverse order.

3.4 Connecting the AC Adapter



This section describes connecting the 9418-15 AC Adapter to the instrument in order to supply power.

!WARNING

- Turn the instrument off before connecting the AC adapter to the instrument and to AC power.
- Use only the supplied Model 9418-15 AC Adapter. AC adapter input voltage range is 100 to 240 VAC (with $\pm 10\%$ stability) at 50/60 Hz. To avoid electrical hazards and damage to the instrument, do not apply voltage outside of this range.
- To avoid electrical accidents and to maintain the safety specifications of this instrument, connect the power cord provided only to a 3-contact (two-conductor + ground) outlet.

!CAUTION

To avoid damaging the power cord, grasp the plug, not the cord, when unplugging it from the power outlet.

NOTE

- Make sure the power is turned off before connecting or disconnecting the AC adapter.
- The instrument will run erratically under a momentary power outage lasting less than 40 ms. However, if a momentary power outage lasting 40 ms or more occurs, the instrument may turn off temporarily, so the state of the power supply at the installation location should be considered beforehand.
- If a power outage occurs, the measurement data is lost.
- If the instrument is run on a 12 V battery without using the AC adapter and is connected to the battery with a cable of 3 m or longer, measurement may be affected by external noise and other electromagnetic interference.

- 1. Make sure the instrument is OFF.**
- 2. Connect the connector of the AC adapter to the connector of the instrument, and insert the plug into a power outlet with a ground.**

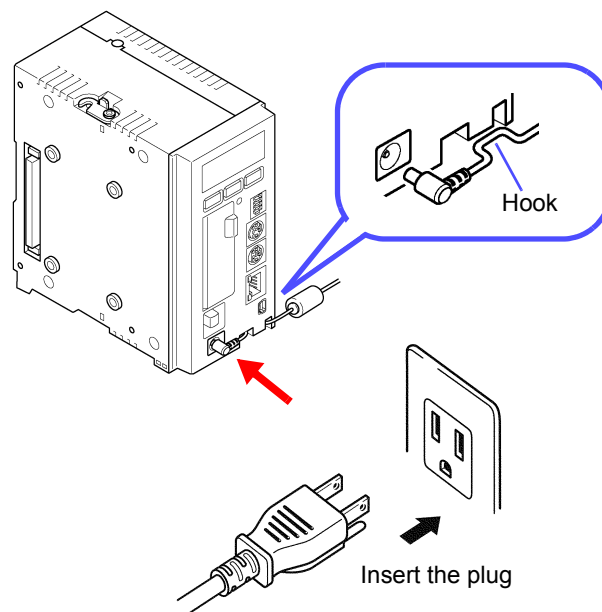

3.5 Connecting a Communication Cable

A computer is used to set the instrument, record measurement data, and analyze recorded data. Use the USB cable or 9642 LAN Cable to connect the instrument and computer.

CAUTION

- To avoid a malfunction, do not connect or disconnect the USB cable or LAN cable during operation.
- To ensure stable communication, connect either just the USB cable or just the LAN cable and then take measurements.

Be sure to install the supplied software Logger Utility on the computer before connecting the USB cable to the computer for the first time.

3.5.1 Connecting the USB Cable

When you want to measure via USB, connect the instrument and computer with the supplied USB cable. To ensure stable communication, do not connect the LAN cable when measuring via USB.

When connecting the instrument and computer directly on a one-to-one-basis:

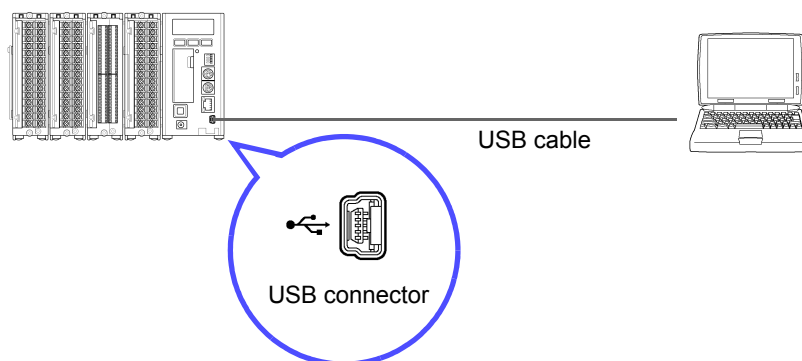

When connecting multiple Memory HiLoggers to a computer:

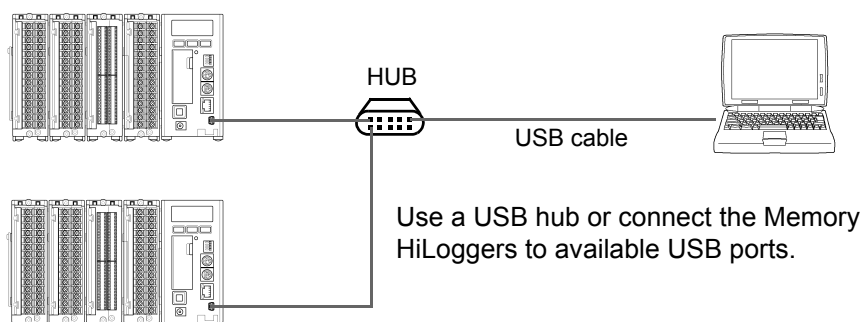

3.5.2 Connecting the LAN Cable

When you want to measure via LAN, connect the instrument and computer with the LAN cable. To ensure stable communication, do not connect the USB cable when measuring via LAN.

When connecting the instrument and computer directly on a one-to-one-basis: The 9642 LAN Cable is straight cable, so use the supplied adapter connector when connecting the instrument and computer directly on a one-to-one basis.

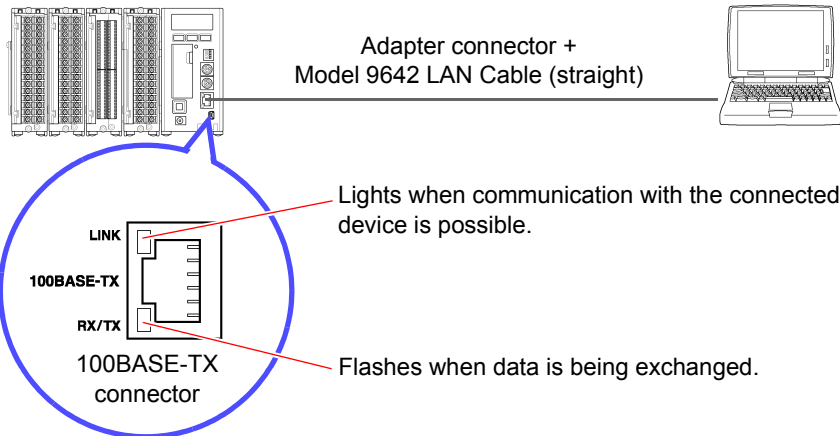

When connecting via a hub:

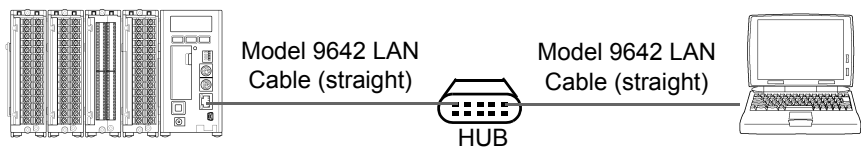

NOTE

- When you want to communicate between the instrument and computer via LAN, configure the network settings of the instrument.
- When connecting to an existing LAN network, obtain the settings from the network administrator.
- When the instrument will be affected by external noise, attach the supplied ferrite clamp as shown in the figure below.

Attaching the Ferrite Clamp

- 1. Wrap the LAN cable around the ferrite clamp once.**
Attach the ferrite clamp at a position that is 2 to 4 cm away from the connector to be connected to the instrument.
- 2. Close the ferrite clamp until a click is heard.**

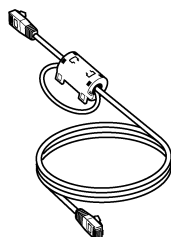

3.6 Using a CF Card

If you insert a CF card in the instrument and set real-time saving, data can be saved to the hard disk of the computer and the CF card simultaneously during measurement. Furthermore, standalone measurement in which the instrument measures when not connected to the computer is made possible by saving the measurement data to a CF card.

Important

Use only PC Cards sold by Hioki.

Compatibility and performance are not guaranteed for PC cards (use a CF card only; do not use an adapter) made by other manufacturers. You may be unable to read from or save data to such cards.

Hioki options

PC cards (includes adapter)

- Model 9726 PC Card 128M
- Model 9727 PC Card 256M
- Model 9728 PC Card 512M
- Model 9729 PC Card 1G

3.6.1 Formatting a CF Card

Format a CF card on a computer the first time you use it or before you begin measurement. If the CF card has been used for another purpose, saving may take a while or the file information may be damaged. Formatting will prevent these problems from occurring.

1. Right-click the removable disk containing the CF card in My Computer, and then click **[Format]** from the menu.
2. Select **[FAT]** or **[FAT32]** as the file system in the dialog box, and then click **[Start]**.
Formatting of the CF card starts.

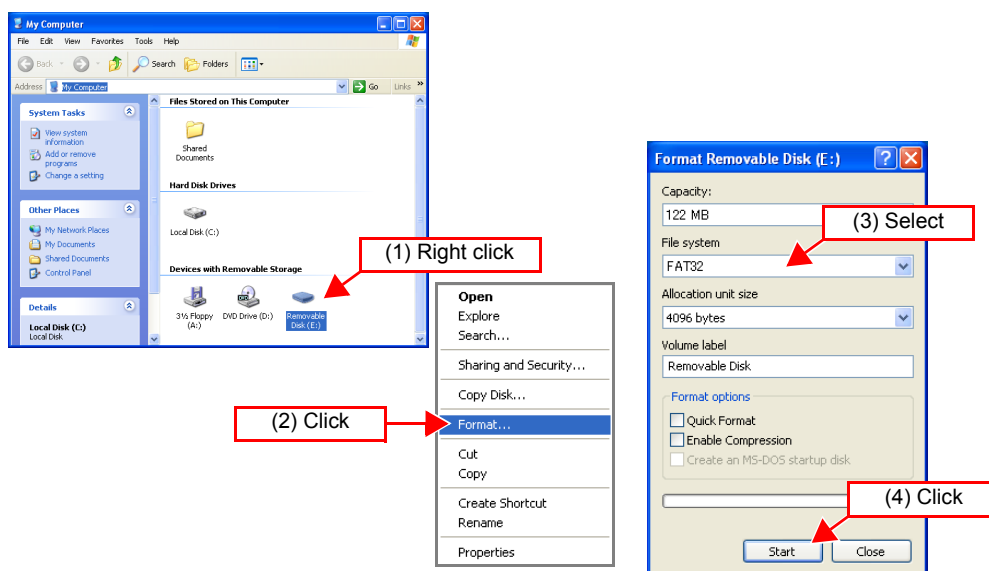

3.6.2 Inserting and Ejecting a CF Card

Inserting a CF Card

1. Open the cover of the CF card slot.
2. When the eject button comes out, fully press it all the way in.

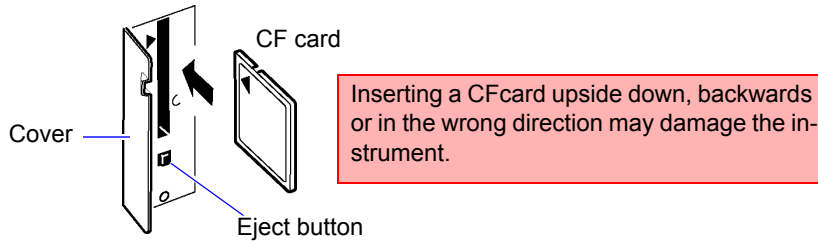

3. Fully insert the CF card from the front with the top surface facing left (cover side), and then close the cover. Confirm that the CF card access LED lights. The cover cannot be closed unless the eject button is pushed in.

Ejecting a CF Card

1. Fully press the eject button, and then remove your finger from the button.
2. When the eject button pops out, press it in again to eject the CF card.

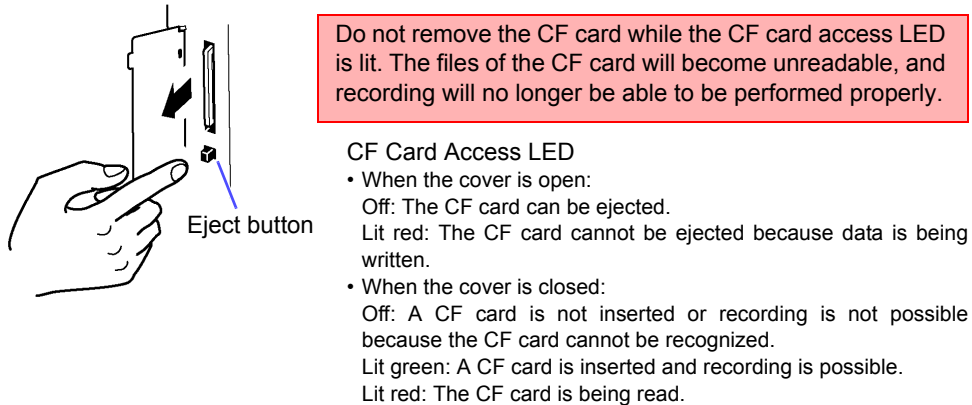

NOTE

- Be sure to close the cover after inserting a CF card. Measurement data will not be saved to the CF card if the cover is not closed.
- When measurement will be performed for a long period of time, first, back up all files on the CF card by copying them to a drive on the computer. Then, format the CF card so that there are no unnecessary files. It is recommended to perform a backup and format each time you measure.
- If the cover of the CF card slot cannot be closed properly, submit the instrument for repair. Recording to the CF card may stop if, for instance, vibration causes the cover to open during measurement.

3.6.3 Replacing a CF Card during Measurement

While data is being saved to a CF card in real time, you can replace the CF card without stopping measurement.

1. Open the CF card slot cover.
2. Confirm that the CF card access LED is off, and then eject the CF card.
3. Insert a CF card with sufficient available space, and then close the cover.

CAUTION

As the CF card is sensitive to static electricity, damage to the CF card or wrong operations by the HiLogger may occur due to static electricity. Please be careful when handling it.

NOTE

- The CF card access LED may sometimes be lit red immediately after you open the cover, because the CF card is being processed. Ejecting the card in such a state will result in the files of the CF card being damaged. Always make sure the LED is off before ejecting a CF card.
- Be sure to close the cover after inserting a CF card. Measurement data will not be saved if the cover is not closed.
- If the CF card is not replaced within 5 minutes, the data of the internal memory may overflow and the measurement data may not be saved.
- If measurement ends while no CF card is inserted, the data up until the end of measurement will not be saved even if you insert a CF card afterwards. In such a case, you can use the HTTP function to extract the data in the instrument while the instrument is connected to the LAN. See "Chapter 11 Communications (HTTP/FTP)" (p. 209).

3.6.4 File Protection during Power Outage

The instrument has a large built-in capacitor that processes the ending of files when the power is switched off or there is a power outage. This greatly reduces the risk of files being damage by an unexpected power outage.

NOTE

A CF card cannot be accessed for 30 seconds immediately after the power is turned on because the large capacitor is being charged.

3.7 Connecting Synchronization Cables

Connecting multiple Memory HiLoggers with optional 9683 Connection Cables (for synchronization) and using the supplied software Logger Utility to set synchronized measurement allows you to synchronize the sampling of the loggers and perform synchronized measurement with up to 600 channels. In such a case, you can share trigger function and event mark information, as well as perform an external start, external stop, and synchronization by external sampling. For external sampling, input a sampling signal to the master Memory HiLogger. It is possible for multiple loggers connected by the 9683 Connection Cables (for synchronization) to measure at the same timing.

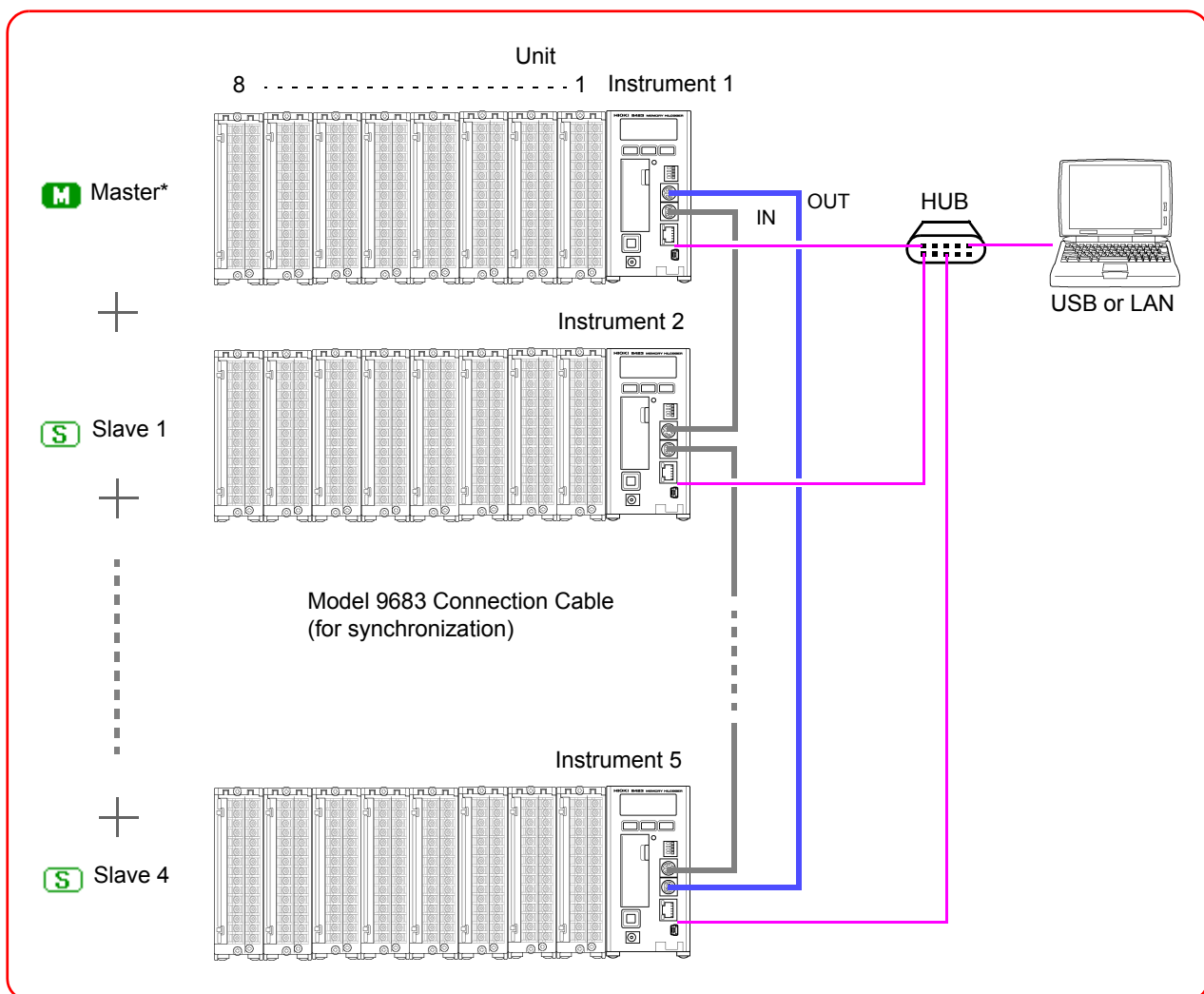

* Master:

Generates a synchronization clock to adjust the sampling of slaves 1 to 4.

1. Connect the 9683 Connection Cables (for synchronization) to the IN and OUT synchronization cable connectors of the Memory HiLoggers so that loops are created.

Connect the connector of the end with the ferrite clamp attached to the IN terminal. Align the arrows (▶) on the front of the instrument and on the 9683 Connection Cables when you connect the cables.

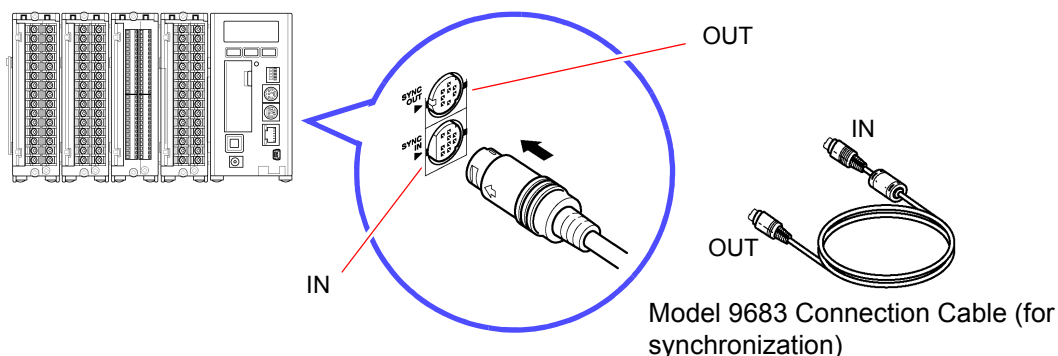

2. Connect all of the Memory HiLoggers to be used for synchronized measurement to the computer with LAN or USB cables.
3. Register the loggers in Logger Utility, and then set synchronized measurement.

See "Chapter 5 Setting Measurement Conditions" (p. 63).

NOTE

- The synchronization settings can also be set on the instrument.
- Synchronized measurement is possible with two to five loggers. Synchronized measurement is not possible with one or six or more loggers.
- Multiple masters cannot be assigned to one measurement system.
- The sampling clock is transferred via the 9683 Connection Cables during synchronized measurement. Never disconnect the 9683 Connection Cables during measurement, because the supply of the clock will stop.
- The IN and OUT connectors of a 9683 Connection Cable differ. Do not use excessive force to insert a connector.
- Turn on the power of all 8423 Memory HiLoggers connected with the 9683 Connection Cables.

3.8 Connection Method for External Control Input Terminals

Inputting a signal from an external device enables the input signal to be a trigger source, and measurement to be started and stopped. Furthermore, you can collect data (external sampling) at any timing with which you want to measure.

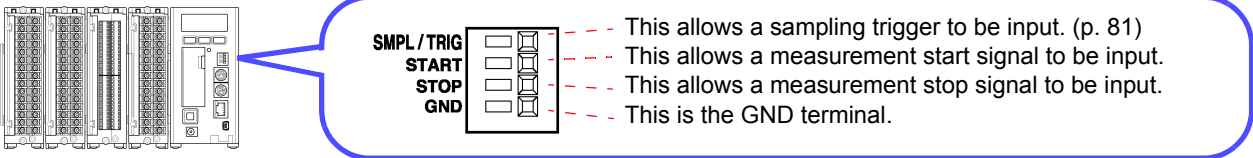

! DANGER

To avoid electrical hazards and damage to the instrument, do not apply voltage outside of the range (DC -5 to 10 V) to the External control input terminals.

! WARNING

To avoid electric shock or damage to the equipment, always observe the following precautions when connecting to External control input terminals.

- Always turn off the power to the instrument and to any devices to be connected before making connections.
- Be careful to avoid exceeding the ratings of external terminals and connectors.
- Ensure that devices and systems to be connected to the External control input terminals are properly isolated.

! CAUTION

- The GND of the external control input terminals and the GND of the Memory HiLogger main unit are not commonly insulated. To avoid damaging the instrument, make sure wiring is done in such a manner that no potential difference can result between the GND of the external control input terminals and the GND of the equipment or device to be connected.

- To avoid electric shock, use the recommended wire type to connect to the current input terminals, or otherwise ensure that the wire used has sufficient current handling capacity and insulation.

- Recommended wire
- Single strand: 1.0 mm dia. (AWG 18)
 - Multi-strand: 0.75 mm² (AWG 20)
- Acceptable limits
- Single strand: 0.4 to 1.0 mm dia. (AWG 26 to 18)

- Multi-strand: 0.3 to 0.75 mm² (AWG 22 to 20)
- Strand diameter: minimum 0.18 mm
- Standard insulation stripping length: 10 mm
- Button pressing tool: Blade screwdriver (tip width 2.6 mm)

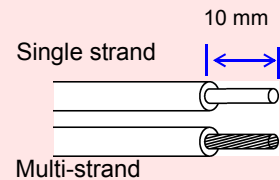

3.8 Connection Method for External Control Input Terminals

Required tools: Flat blade screwdriver 1

1. Press the button of the terminal with a flat blade screwdriver (or other tool).

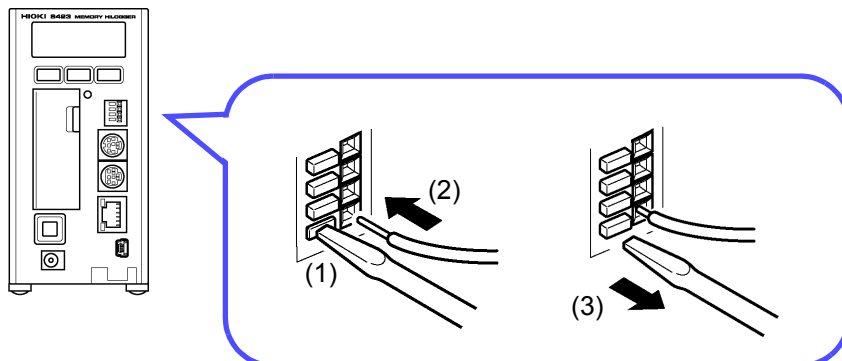

2. While keeping the button pressed in, insert the wire into the hole of the terminal.
3. Release the button to lock the wire into place.

<Circuit Diagram of External Control Input Terminals>

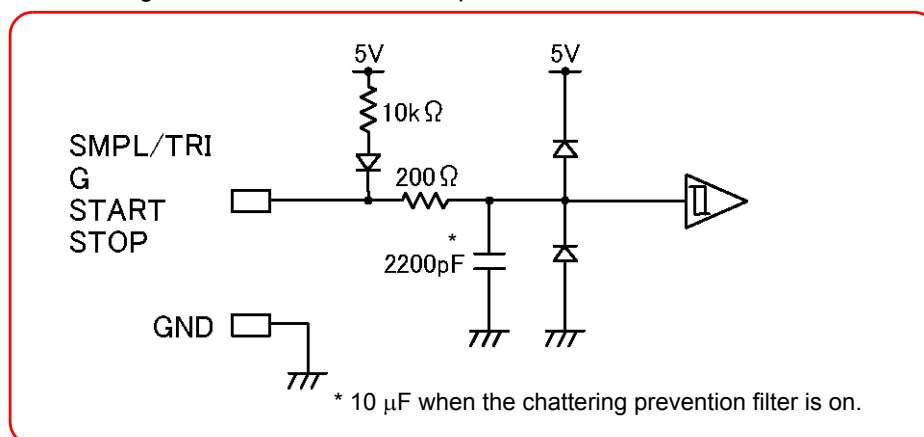

NOTE

When using multiple loggers to measure with the external sampling function, care should be taken with the following points.

- Always connect the 9683 Connection Cables when synchronized measurement will be performed. Furthermore, only use the SMPL/TRIG terminal for the master.
- Disconnect the 9683 Connection Cables when synchronized measurement will not be performed. Furthermore, input the same signal into the SMPL/TRIG terminal of all loggers.

3.9 Turning the Power On and Off

! WARNING

To avoid an electric shock or short-circuit accident, confirm the following items before turning on the power.

- When using the AC adapter, make sure the power supply is a rated supply voltage (100 to 240 VAC) and rated supply frequency (50/60 Hz) of the instrument. (Voltage fluctuations of $\pm 10\%$ from the rated supply voltage are taken into account.)
- Make sure the instrument is installed properly. (p. 6)

! CAUTION

To avoid damaging the instrument, make sure the input cables are connected properly.

Power On

- 1. Press the power switch until you hear clicking sound to turn the power on (I).**
- 2. The instrument enters a startup state.**
The model name and version appear on the screen, and then the instrument enters the standby state (clock displayed).

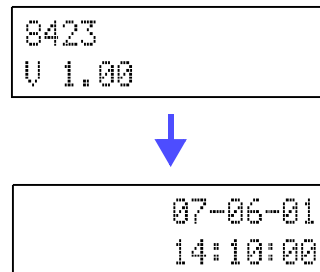
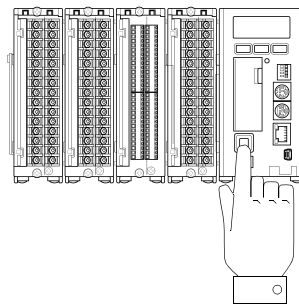

Power Off

- 1. Fully press the power switch, and then remove your finger to turn the power off (O).**

NOTE

The settings are stored immediately after the power is turned off. The next time you turn the power on, the settings will be in the same state as immediately before the power was turned off. However, the measurement data will be cleared.

Software Screen Chapter 4

This chapter describes the screen configuration, part names, and functions of the supplied software Logger Utility.

4.1 Main Screen

When you start Logger Utility, the main screen appears. This is the basic screen of Logger Utility.

4

Menu Bar

File View Help

Saves and loads measurement data and setting data, print waveforms, etc.

Tool Button



Displays the settings screen, starts and stops measurement, etc.

Waveform Display Area

Displays measurement data as waveforms.

Measurement Condition

Displays measurement condition as "Measuring", "Stop", "Waiting for TRIG", etc.

Display Settings Windows

Click the tabs on the right side to display setting items. The windows allow for configuring the advanced settings of the waveform display area, analyzing data, etc.

List Display Area

Displays measurement data as numerical values.

Settings Screen

Allows for setting measurement conditions.

Status Bar

Displays the status of the main screen.

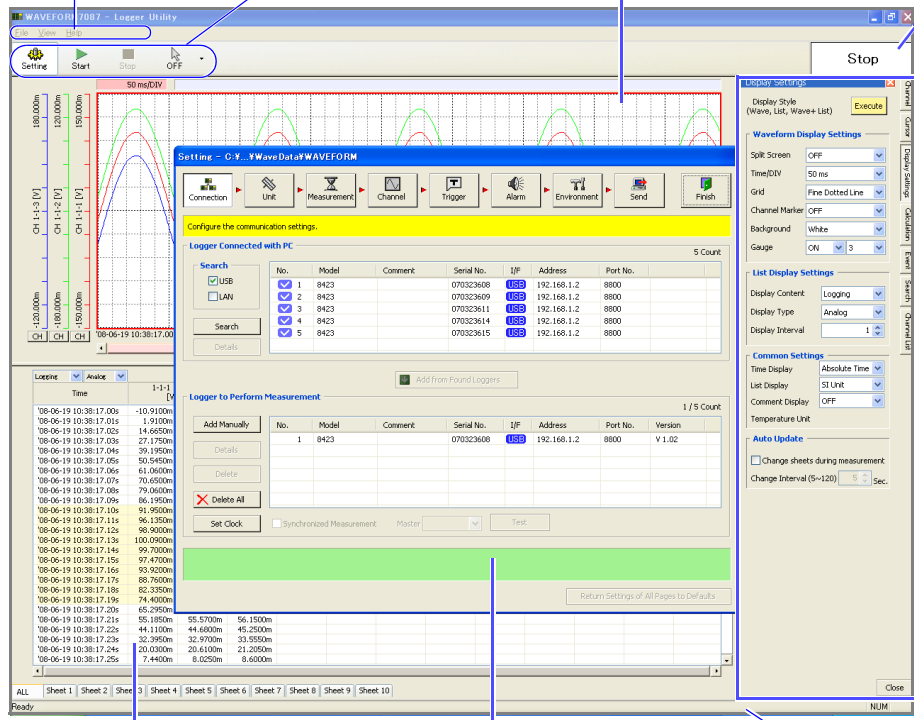

The screenshot shows the Logger Utility main screen. At the top is a menu bar with 'File', 'View', and 'Help'. Below it is a tool bar with 'Setting', 'Start', 'Stop', and 'OFF' buttons. The main area is divided into a waveform display area (top left) showing multiple colored waveforms, and a list display area (bottom left) showing a table of measurement data. On the right side, there are several settings windows, including 'Display Settings' and 'Common Settings'. At the bottom, there is a status bar showing 'Ready' and 'NUM'.

Menu Bar

[File] Menu

The menu bar contains three menus: File, Display, and Help.

This menu includes items for saving and loading files, printing waveforms, initializing Logger Utility, etc.

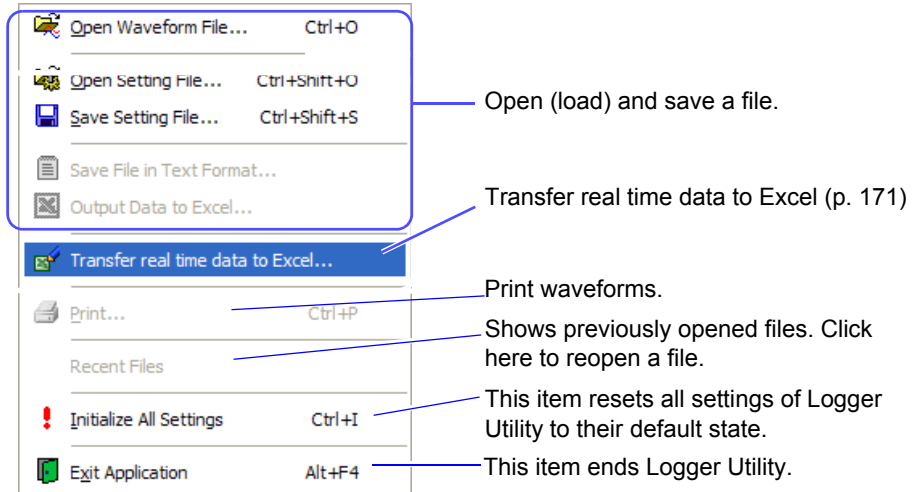

[View] Menu

This menu is for displaying/hiding the status bar.





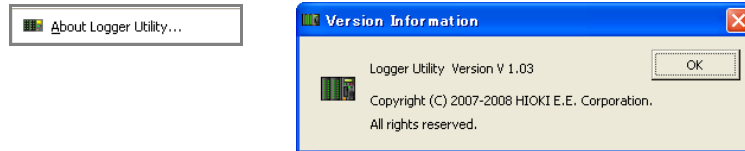

[Help] Menu

This menu is for displaying the software version of Logger Utility.



Tool Button

The tool buttons are for control such as displaying the measurement settings, or starting and stopping measurement.

Tool buttons	Explanations
	Displays the settings screen.
	Starts measurement.
	Stops measurement.
	Displays the A and B cursors, and inserts event marks.

Waveform Display Area

This area displays the measurement waveforms. You can also split the screen to display two waveforms. The frame of the active screen is emphasized. See "7.3 Changing Display Settings" (p. 142).

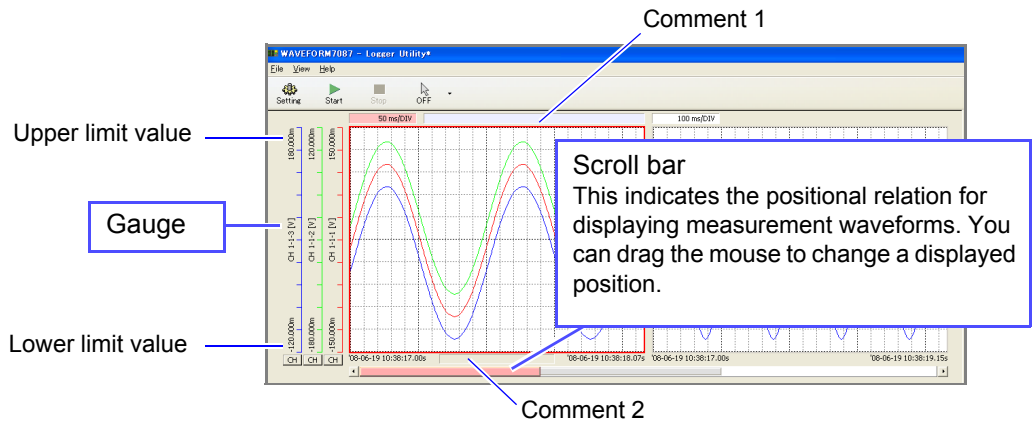

Double-clicking a comment enables it to be set. Enter characters with the keyboard, and then press the **Enter** key.

List Display Area

This area displays measurement waveforms and calculation results as numerical values.

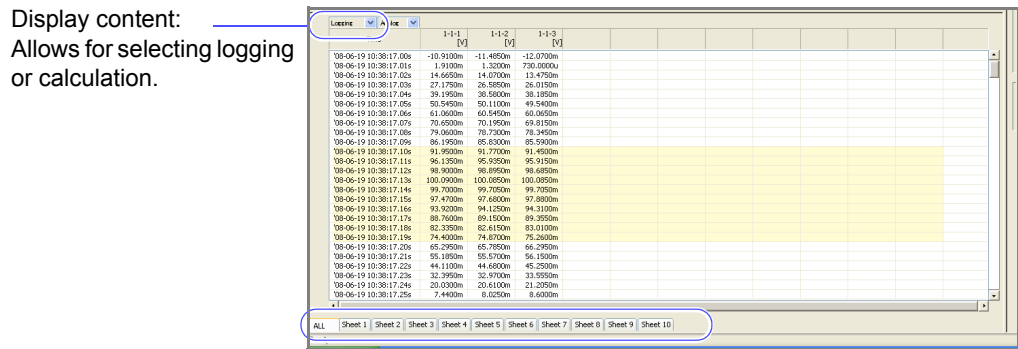







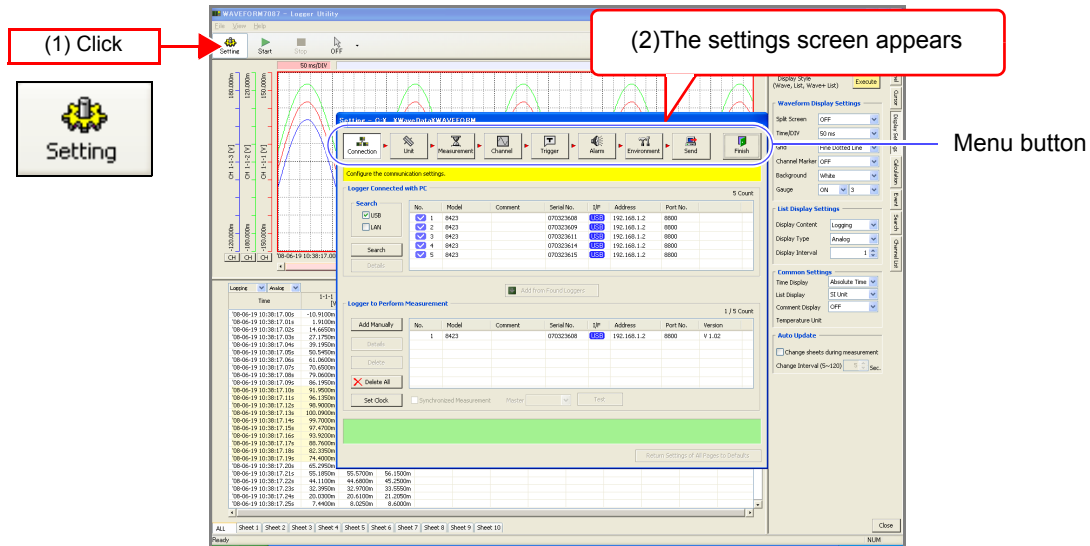

NOTE

- Scrolling and changing sheets apply to the active screen.
- When logging is selected for the display content, you can select the display type (analog, logic, alarm, waveform calculation, or all) for the next column on the right. When logging is selected and an alarm setting is enabled, the alarm status is displayed on the far left.

4.2 Settings Screens

Click the **[Setting]** button in the main screen to display the settings screen. Click the menu buttons to display various setting pages, and configure settings. See "Chapter 5 Setting Measurement Conditions" (p. 63).



Menu buttons	Setting pages	Explanations
	Connection (p. 64)	This page is for setting the logger for measurement.
	Unit (p. 75)	This page is for confirming the units attached to the logger, setting the digital filter, etc.
	Measurement (p. 77)	This page is for setting the measurement conditions, data save method, etc.
	Channel (p. 89)	This page is for setting the measurement range for each channel, display conditions, etc. This page is for setting the waveform calculation also.
	Trigger (p. 105)	This page is for setting trigger conditions.
	Alarm (p. 118)	This page is only enabled when the 8997 Alarm Unit is attached. It allows for setting the output condition and action upon alarm generation.
	Environment (p. 121)	This page is for setting the external control input terminals, CF card save format, etc. It is for operations that work only on the Memory HiLogger main unit.
	Send (p. 127)	This page is for sending the settings to the Memory HiLogger.

[Connection]

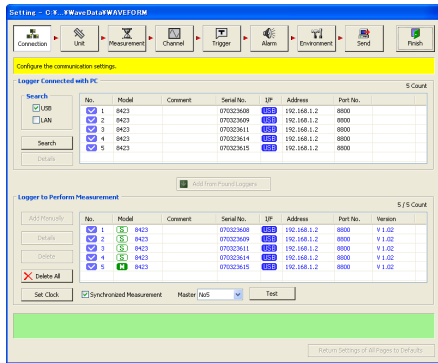

[Trigger]

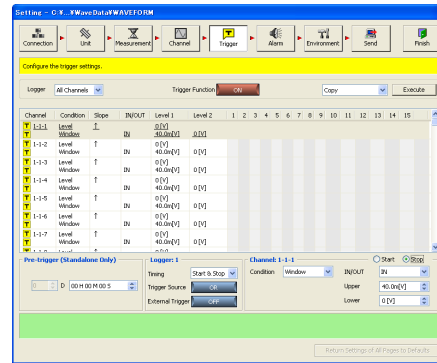

[Unit]

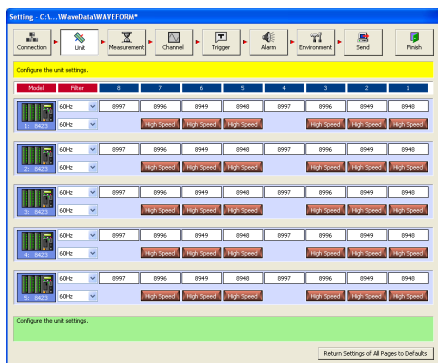

[Alarm]

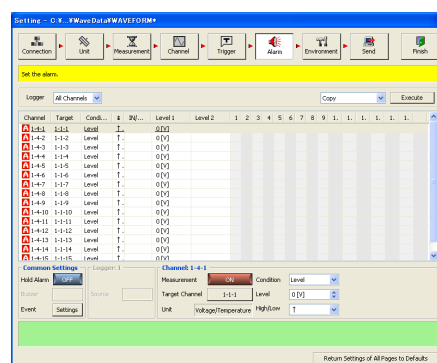

[Measurement]

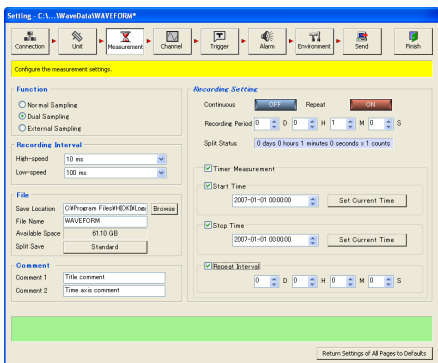

[Environment]

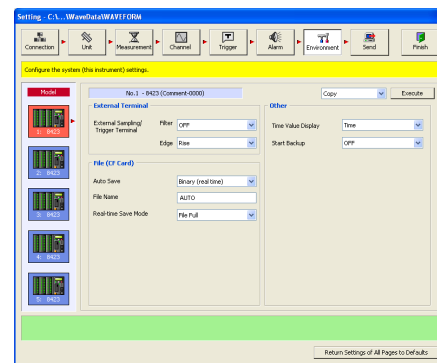

[Channel]

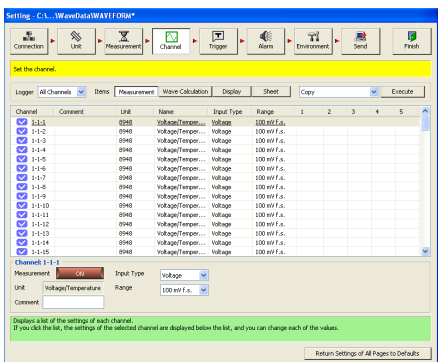



If part of the settings screen is not displayed:

Windows 2000

The DPI setting for the display may be set to other than [Normal size (96 DPI)]. Select [Control Panel] - [Display] - [Settings] - [Advanced] - [General] to open the following screen, and then set the setting to [Normal size (96 DPI)].

Windows XP

The DPI setting for the display may be set to other than [Normal size (96 DPI)]. Select [Control Panel] - [Appearance and Themes] - [Display] - [Settings] - [Advanced] - [General] to open the following screen, and then set the setting to [Normal size (96 DPI)].

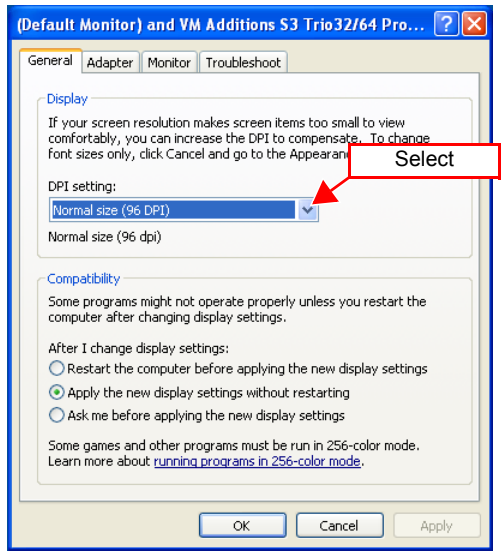
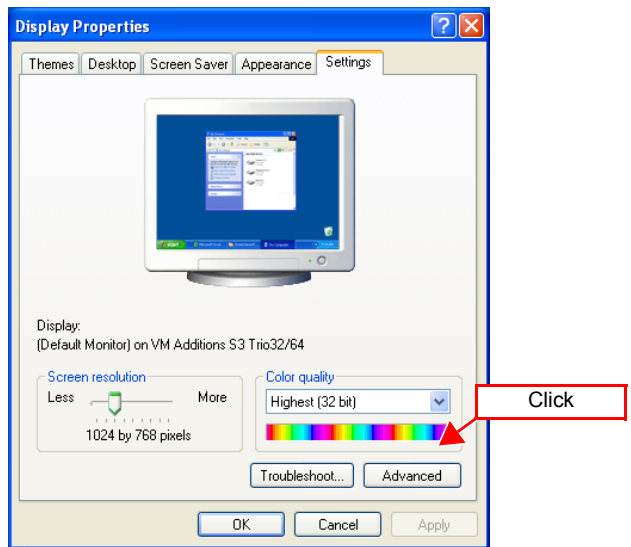



Windows Vista

Select [Control panel] - [Appearance and Personalization] - [Personalization] - [Adjust font size(DPI)]. The dialog asking for permission will appear, so that click [Continue]. On DPI Scaling Dialog, select the setting to [Default scale(96DPI)].

(1) Click

(2) Click

(3) Click

(4) Click

(5) Click

The sequence shows the following steps: 1. Clicking on 'Appearance and Personalization' in the Control Panel. 2. Clicking on 'Personalization' in the 'Appearance and Personalization' window. 3. Clicking on 'Adjust font size (DPI)' in the 'Personalization' window. 4. Clicking on 'Continue' in the 'User Account Control' dialog box. 5. Clicking on 'Default scale (96 DPI) - fit more information' in the 'DPI Scaling' dialog box.

Windows 7

Select [Control panel] - [Appearance Personalization] - [Display]. On Display Dialog, select the setting to [smaller - 100%(default)].

(1) Click

(2) Click

(3) Click

The sequence shows the following steps: 1. Clicking on 'Appearance and Personalization' in the Control Panel. 2. Clicking on 'Display' in the 'Appearance and Personalization' window. 3. Clicking on 'Smaller - 100% (default)' in the 'Display' dialog box.

4.3 Display Settings Windows

Click tabs on the right edge of the main screen to display windows for setting the waveform display area and confirming items such as measurement conditions. See "Chapter 7 Analyzing Measurement Data" (p. 139).

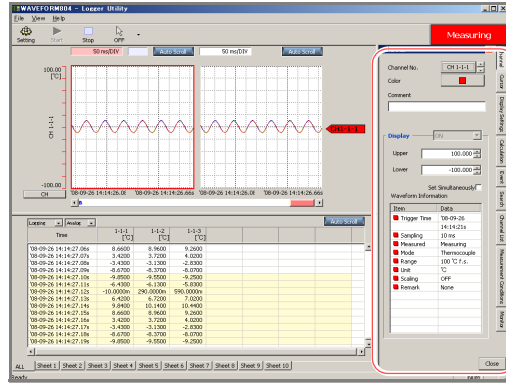
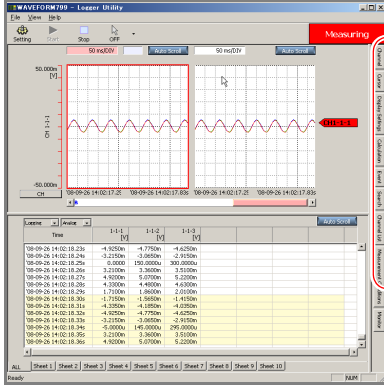

[Channel]

Channel No. CH1-1-1
Color
Comment
Display
Upper 50.000mV
Lower -50.000mV
Set Simultaneously
Waveform Information
Items Data
Trigger Time 10.00ms
Sampling 10ns
Measured 2556
Mode Voltage
Range 100 mV f.s.
Unit V
Scaling OFF
Remark None

Set the display method for any channel. Waveform information is also displayed.

[Calculation]

Channel All Channels
Range Whole Range
Filter OFF
Threshold Value
Channel No. CH1-1-1
+0.0000e+000 Y
Calculation Type
Average Off Time
P/P On Count
Maximum Off Count
Minimum Off Count
Trend to Maximum Off Count
Trend to Minimum Off Count
Time to Minimum Area Value
Time to Maximum Integral
Execute
Copy Result to Clipboard
Display Result in List

Set calculation items and calculation ranges.

[Channel List]

Display
Display Channel Priority
CH1-1-1 [C]
CH1-2-1 [C]
CH1-3-1 [C]
CH1-4-1 [C]
CH1-5-1 [V]
CH1-6-1 [V]
CH1-7-1 [V]
CH1-8-1 [V]
CH1-9-1 [V]
CH1-10-1 [V]
CH1-11-1 [V]
CH1-12-1 [V]
CH1-13-1 [V]
CH1-14-1 [V]
CH1-15-1 [V]
CH1-16-1 [V]
CH1-17-1 [V]
CH1-18-1 [V]
CH1-19-1 [V]
CH1-20-1 [V]
CH1-21-1 [V]
CH1-22-1 [V]
CH1-23-1 [V]
CH1-24-1 [V]
CH1-25-1 [V]
CH1-26-1 [V]
CH1-27-1 [V]
CH1-28-1 [V]
CH1-29-1 [V]
CH1-30-1 [V]

Switch the channel display for the currently selected sheet.

[Cursor]

ON/OFF
A 10.00ms
B 10.00ms
A-B 0.00ms
Move A and B simultaneously
All Channels Sheet Selected
CH A B
1-1-1 0.0000 0.0000
1-1-2 300.0000 300.0000
1-1-3 600.0000 600.0000
1-1-4 900.0000 900.0000
1-1-5 600.0000 600.0000
1-1-6 750.0000 750.0000
1-1-7 900.0000 900.0000
1-1-8 1.0000 1.0000
1-1-9 1.2000 1.2000
1-1-10 1.5000 1.5000
1-1-11 1.5000 1.5000
1-1-12 1.8000 1.8000
1-1-13 1.8000 1.8000
1-1-14 1.8000 1.8000
1-1-15 2.0000 2.0000
1-2-1 -2.0000 -2.0000
1-2-2 -1.8000 -1.8000
1-2-3 -1.8000 -1.8000
1-2-4 -1.8000 -1.8000
1-2-5 -1.8000 -1.8000

Set cursors A and B.

[Event]

Event Mark ON
Event No. 1
Position 10.00ms
Comment 10.00ms
Mark
Display The Position
Move Cursor A to This Position
Delete This Event
Delete All Events
No. Comment
1 10.00ms 14.16:21.94s
2 10.00ms 14.16:22.05s
3 10.00ms 14.16:22.07s
4 10.00ms 14.16:22.13s

Perform tasks such as switching and editing the event mark display.

[Measurement Conditions]

Start Time 10.00ms 14.20:32.00s
End Time
Elapsed Time 0.00:00.00s
Save Progress
CF Status
No. 1
No. 2
No. 3
No. 4
No. 5
No. 6
No. 7
No. 8
No. 9
No. 10
Measurement Information
Sampling 10ns
Set Max 356
Measured 356
Save Log
10.00ms 14.20:32.00s StartSEC
10.00ms 14.20:32.00s StartSEC
Alarm View

Display measurement progress. (Displayed only during measurement)

[Display Setting]

Display Mode (Wave, List, Wave List)
Waveform Display Settings
Split Screen OFF
TimeDiv 50ms
Grid Fine Dotted Line
Channel Marker Channel No.
Background White
Gauge ON
List Display Settings
Display Content Logging
Display Type Analog
Display Interval 1
Common Settings
Time Display Absolute Time
List Display ON USE
Comment Display OFF
Temperature Unit
Auto Update
Change sheets during measurement
Change Interval (5-120) Sec.

Set the display method for the waveform display area and list display area.

[Search]

Range Whole Range
Method Copy by Time
New Value
Search
Execute
Search Position
Move Cursor A to Search Position
Set Event at Search Position
Clear Search-Position Information

Search the measurement data for parts that match the conditions.

[Monitor]

CH	Value	Difference
1-1-1	4.4000	6.4000
1-1-2	4.7000	6.4000
1-1-3	3.7000	6.4000
1-1-4	7.2000	6.4000
1-1-5	3.8000	2.1500
1-1-6	3.9000	2.1500
1-1-7	4.1000	2.1500
1-1-8	4.2000	2.1500
1-1-9	4.4000	2.1500
1-1-10	4.5000	2.1500
1-1-11	4.7000	2.1500
1-1-12	4.8000	2.1500
1-1-13	5.0000	2.1500
1-1-14	5.1000	2.1500
1-1-15	5.3000	2.1500
1-2-1	5.6000	2.1500
1-2-2	5.8000	2.1500
1-2-3	5.9000	2.1500
1-2-4	6.1000	2.1500
1-2-5	6.2000	2.1500
1-2-6	6.3000	2.1500
1-2-7	6.4000	2.1500
1-2-8	6.5000	2.1500
1-2-9	6.6000	2.1500
1-2-10	6.7000	2.1500
1-2-11	6.8000	2.1500
1-2-12	6.9000	2.1500
1-2-13	7.0000	2.1500
1-2-14	7.1000	2.1500
1-2-15	7.2000	2.1500
1-2-16	7.3000	2.1500
1-2-17	7.4000	2.1500
1-2-18	7.5000	2.1500
1-2-19	7.6000	2.1500
1-2-20	7.7000	2.1500
1-2-21	7.8000	2.1500
1-2-22	7.9000	2.1500
1-2-23	8.0000	2.1500
1-2-24	8.1000	2.1500
1-2-25	8.2000	2.1500

Display the difference between the values of the sample immediately before and the current values. (Displayed only during measurement)

4.4 Channel Indication on Screens

Channel numbers are indicated on Logger Utility screens as shown below.

NOTE

Z1 to Z60 are displayed for the waveform calculation channel.

Example:

Channel number CH1-1-1

Instrument Unit Channel

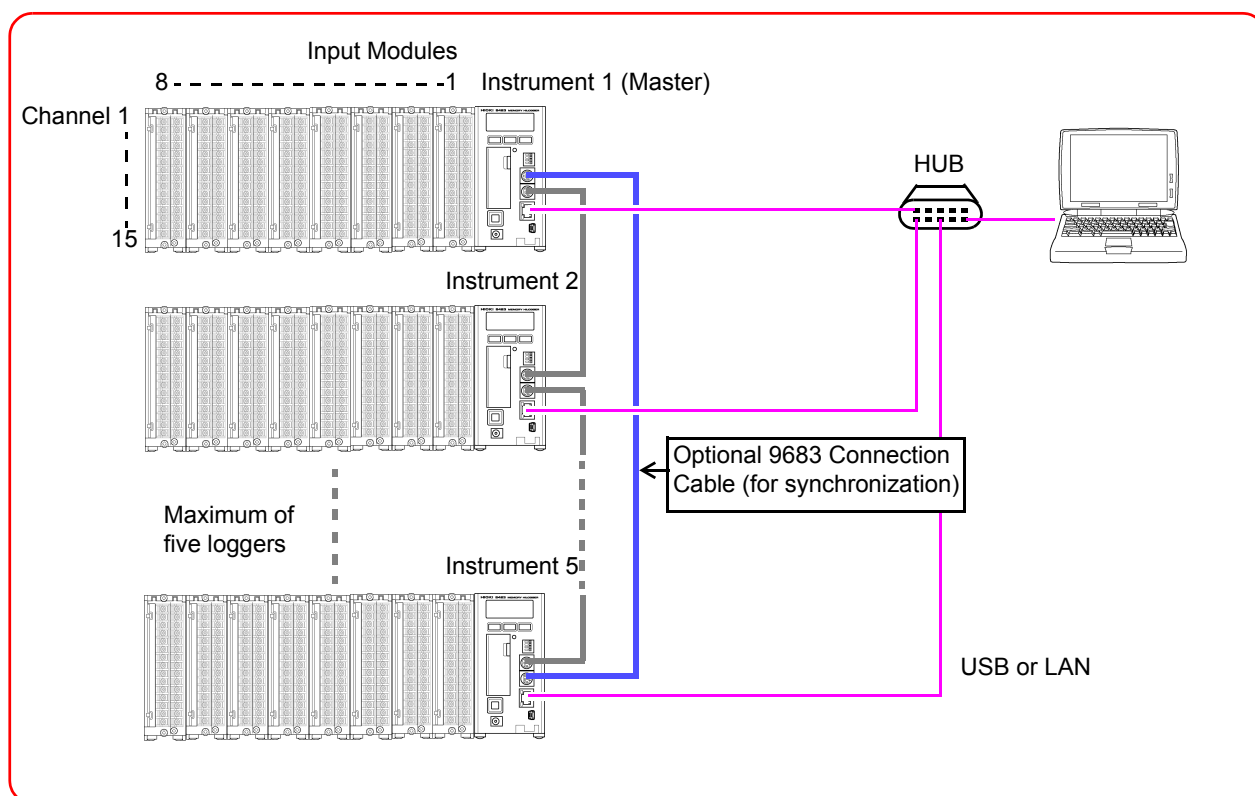

NOTE

For details on how to connect the 9683 Connection Cables (for synchronization), see "3.7 Connecting Synchronization Cables" (p. 48).

Setting Measurement Conditions Chapter 5

Before beginning measurement, set the measurement conditions in the settings screen of the supplied software Logger Utility. Click the **[Setting]** button in the main screen to display the settings screen. Install Logger Utility beforehand. (p. 17)

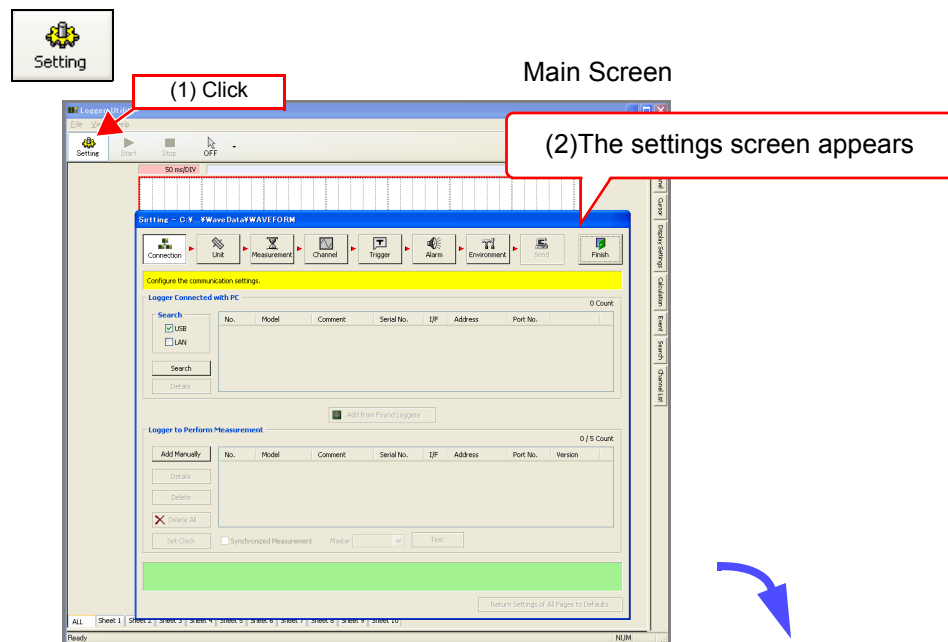

(1) Register the logger for measurement:
Connection settings page (p. 64)

(2) Confirm the unit configuration:
Unit settings page (p. 75)

(3) Configure basic settings for measurement:
Measurement settings page (p. 77)

(4) Configure settings such as the measurement conditions for each channel:
Channel settings page (p. 89)

When setting trigger:

(5) Configure settings for when using the trigger function:
Trigger settings page (p. 105)

When using the 8997:

(6) Configure settings for when using the alarm function:
Alarm settings page (p. 118)

(7) Set the environment conditions of the instrument:
Environment settings page (p. 121)

(8) Send the settings to the logger:
Send the settings (p. 127)

5.1 Registering Loggers in Logger Utility

This section describes registering loggers in Logger Utility, and configuring the connection settings for communication. There are two methods for registering loggers: searching for loggers connected to the computer and then registering them, or configuring settings manually. The search and register method can be used for a logger connected to the computer by a USB cable or a logger connected to the same network by a LAN cable. Searching is not possible if the network is split by, for instance, a router during LAN communication. In such a case, register loggers manually. (p. 68)

5.1.1 Searching and Registering

Search for loggers connected to the computer, and register the loggers for measurement from the found loggers. Up to 256 loggers can be found, and up to 5 of them can be registered. Connect the computer and loggers by LAN cable or USB cable beforehand.

1. Start Logger Utility.

2. Click the  button in the main screen to display the connection settings page of the settings screen.

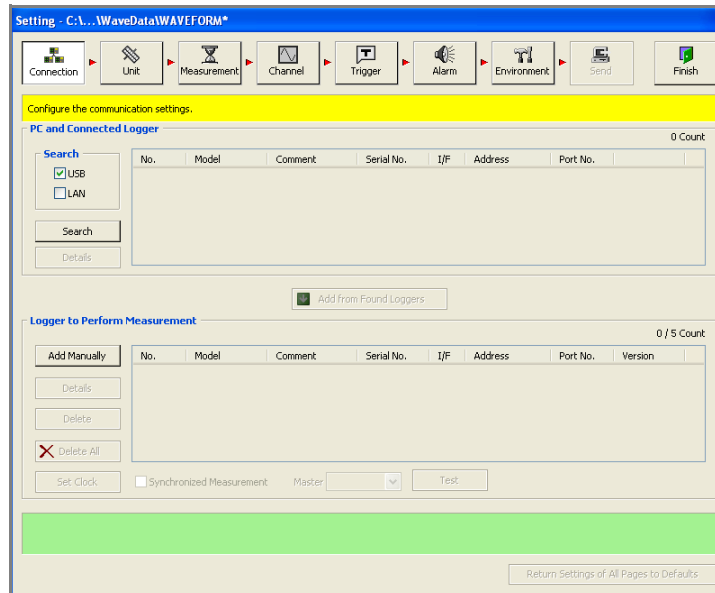

5.1 Registering Loggers in Logger Utility

3. Select the search object from USB and LAN, and then click the [Search] button.

The loggers connected to the computer appear.

 : Loggers that can be registered

 : Loggers performing measurement and loggers of another Logger Utility performing communication

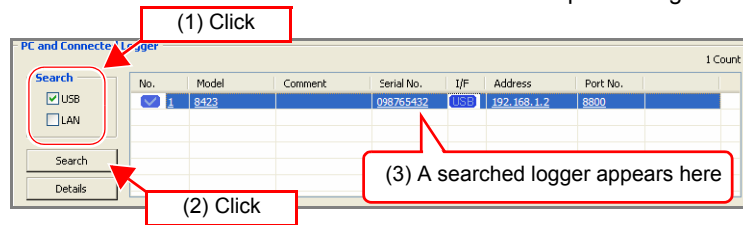

 : Loggers connected by LAN

 : Loggers connected by USB

Selectable Items	Explanations
USB	Searches for loggers connected to the computer by USB cable.
LAN	Searches for loggers connected to the computer by LAN cable. Searching is not possible if the network is split by, for instance, a router. In such a case, see "5.1.2 Registering Manually" (p. 68) and register loggers manually. Use port number 8809 for the logger search.

4. When measuring via LAN, select the logger from the list, and then click the [Details] button.

Configure the network settings in the [Detail Information] dialog box that appears. (This dialog box can also be displayed by right-clicking.)

When measuring via USB, proceed to Step 5.

Be sure to set the IP address and subnet mask.

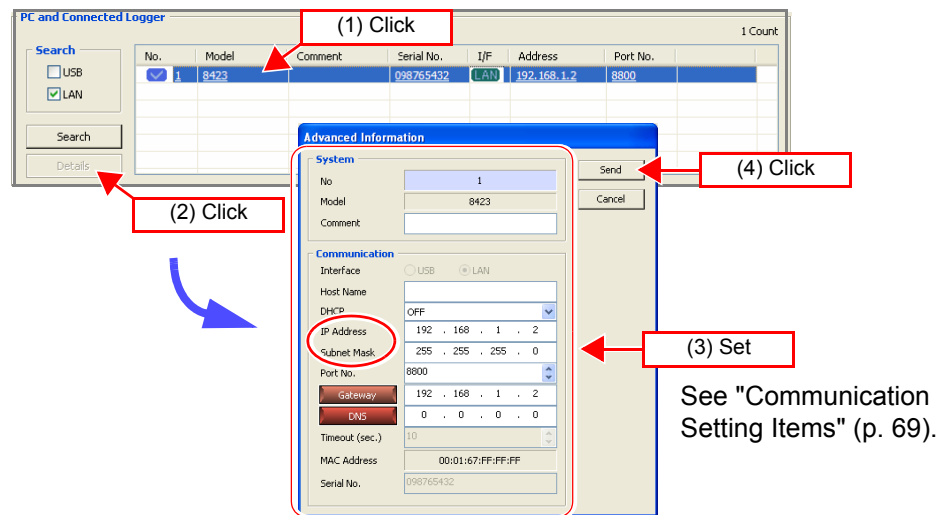

5.1 Registering Loggers in Logger Utility

- 5. Select the logger to register from the list.**
Click the **[Add from Found Loggers]** button to register the selected logger. (A logger can also be added by right-clicking.)

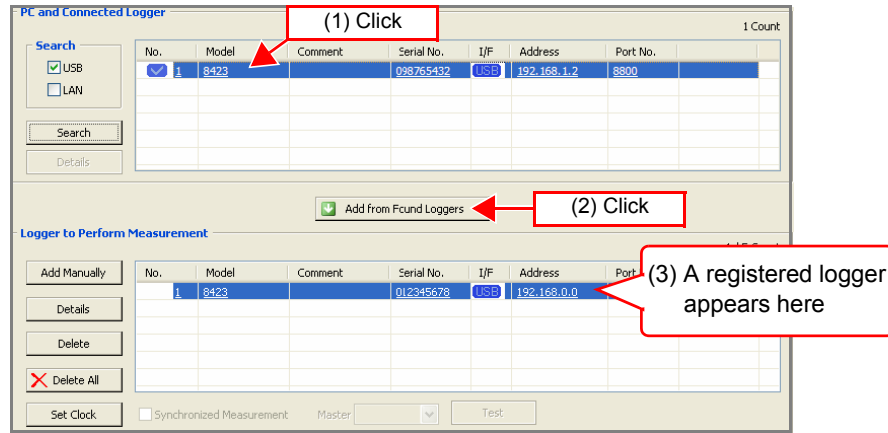

- 6. Register other loggers in the same way.**
When you want to measure with the sampling of multiple loggers synchronized, configure the settings while referring to "5.1.3 Settings for Synchronized Measurement" (p. 74).

NOTE Logger Utility differentiates instruments by serial No.s. It is not possible to register duplicate instruments, such as loggers with the same serial No. The serial No. is on the sticker affixed to the right side of the logger.

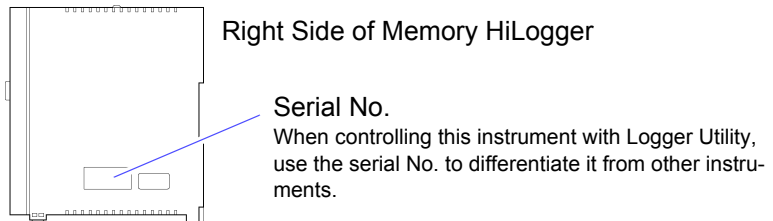

7. Click the **[Set Clock]** button to display the **[Synchronize Clock]** dialog box.

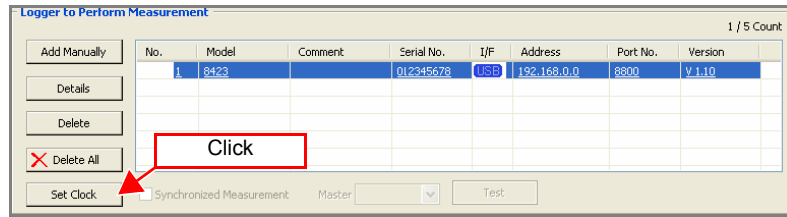

8. Click the **[Set Clock]** button to set the time of each logger to that of the computer.

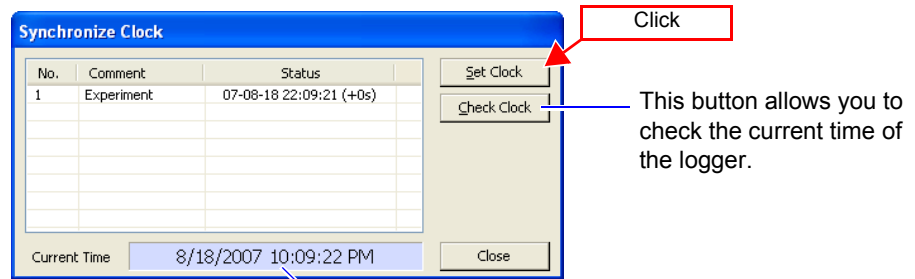

How to delete a specific logger from the registered loggers?

You can register up to five loggers for measurement. Delete a logger when you want to register more than five loggers or remove a registered logger. Select a logger from the list, and then click the **[Delete]** button. If you want to delete all loggers, click the **[Delete All]** button.

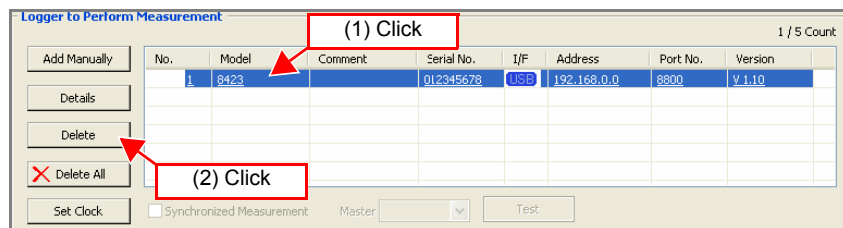

NOTE

- When measuring via a LAN, measurement may not possible if you just search for a logger and then add the logger without changing the communication parameters. Be sure to configure the communication settings.
- To terminate Logger Search task, press the **ESC** key on the keyboard.
- Depending on the timing in which the time is set, a difference of up to ± 1 second may be generated between Logger Utility and the 8423 main unit.

5.1.2 Registering Manually

If searching for a logger is not possible, register it manually. If there are already five loggers registered, a new logger cannot be registered. If you want to delete a registered logger, select the logger and then click the **[Delete]** button.

1. Click the **[Add Manually]** button on the connection settings page to display the **[Add New Logger]** dialog box.

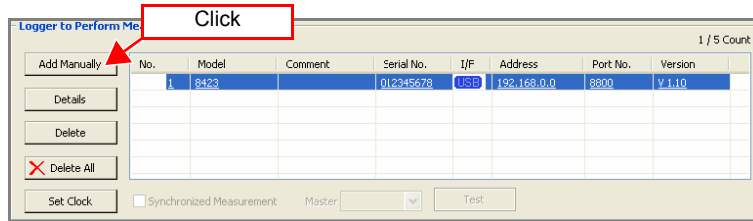

2. Configure the settings while referring to "Communication Setting Items" (p. 69).
Choose 8423 in **[Model]**.
Be sure to set the serial No. in the case of USB, and the IP address in the case of LAN. It is not possible to register duplicate instruments, such as loggers with the same serial No.
3. Click **[Receive]** to receive the logger measurement settings and reflect the settings in Logger Utility.

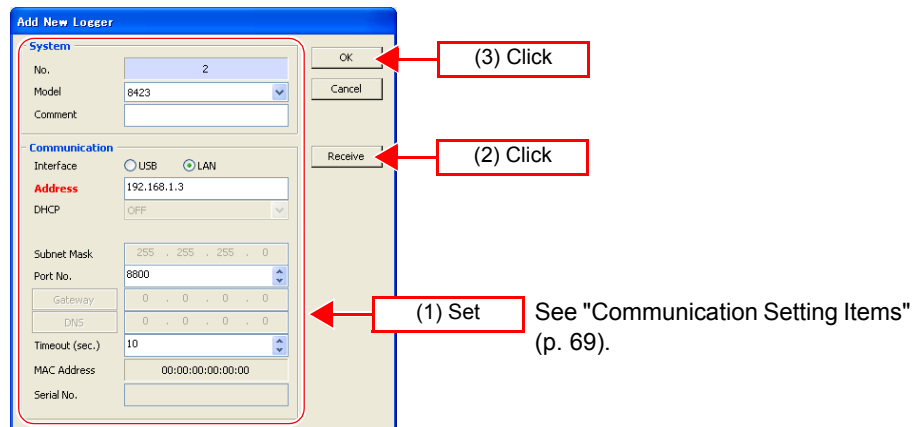

4. Click the **[Set Clock]** button to display the **[Synchronize Clock]** dialog box.
5. Click the **[Set Clock]** button to set the time of each logger to that of the computer.

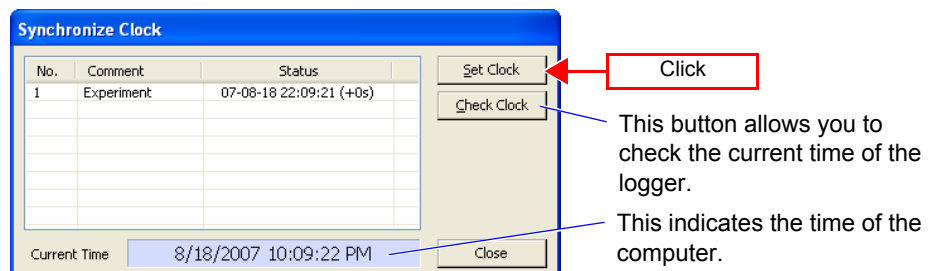

NOTE Depending on the timing in which the time is set, an offset of up to ± 1 second may be generated between Logger Utility and the 8423 main unit.

Communication Setting Items

Setting Items	Explanations	Interface	
		LAN	USB
No	Indicates the number of the logger selected in the list.	-	-
Model	Indicates the model of the logger selected in the list.	*4	*4
Comment	This is for setting the comment of each logger. You can set a comment up to 20 characters long.	*3	*3
Interface	Set whether communication is performed by USB or LAN.	*2	*2
IP Address	Set the IP address of the logger.	*3	-
Address	Set the address for identification on the network. Set an address that is not a duplicate of that of another device on the network. Enter an IP address. Example: 192.168.1.2 You can also enter a host name. If you use a host name, set DNS to ON. This cannot be used in an environment in which a DNS server is not running. You can enter up to 12 alphanumeric characters (0 to 9, a to z, A to Z, and -) to set as the host name. Example: LOGGER	*1	-
DHCP (Dynamic Host Configuration Protocol)	DHCP is a function that enables an instrument to automatically obtain information such as its own IP address and configure the LAN settings accordingly. If DHCP is set to ON and a DHCP server is running within the same network, it is possible to automatically obtain the IP address, subnet mask, and gateway, and configure the settings. IP address: An address for identifying individual devices connected to a network. Set an IP address that is not a duplicate of that of another device. If DHCP is set to ON, the setting is configured automatically. If DHCP fails, the logger sets DHCP to OFF and uses the preset IP address for communication.	*3	-
Subnet Mask	A setting for separating an IP address into the address portion that indicates the network and the address portion that indicates the device. Set the same setting as that of the subnet mask of devices within the same network. If DHCP is set to ON, the setting is configured automatically.	*3	-
Port No.	The logger uses the TCP/IP protocol during communication. TCP/IP allows each communication device to establish multiple connections, so port numbers are used to differentiate between the connections. The logger uses a pre-defined number from 8800 to 8009. There is normally no need to change a port number, but if there is a port that cannot be used because of a network security problem, change the value. The first digit of the port number is reserved.	*2	-
Gateway	When connecting to a network: If the computer is on a different network than the logger, set this to ON and specify the device that will be the gateway. If they are connected to the same network, generally this should be set to same gateway as the computer. When connecting directly to the computer: This setting is not necessary if the computer and logger are connected to the same hub, so set it to OFF. If DHCP is set to ON, the setting is configured automatically.	*3	-

5.1 Registering Loggers in Logger Utility

Setting Items	Explanations	Interface	
		LAN	USB
DNS (Domain Name System)	If DNS is set to ON, specify a communication partner by name instead of IP address. (Since an IP address is a difficult-to-understand sequence of numbers, the use of a name, which is more meaningful to humans, to specify a communication partner was made possible.) If a server (DNS server) capable of obtaining a name from an IP address is running within the network, it is possible to find out an IP address by making an inquiry to the server.	*3	-
Timeout	Set the communication timeout for when controlling the logger with the computer. If communication becomes no longer possible because some kind of trouble occurs during a connection, the computer cuts off communication with the logger and stops measurement after the specified time elapses.	*3	*3
MAC Address	Indicates the MAC address of the logger. The value cannot be changed.	-	-
Serial No.	Indicates the serial No. of the logger. When you add a logger or replace an instrument manually, enter the serial No. on the label affixed to the right side of the logger. If you use search and register, the serial No. is assigned automatically.	-	*1

- *1: Input required
- *2: Input possible
- *3: Setting possible during logger search
- *4: Setting possible during manual registration
- : Input not possible

NOTE

When measuring via a LAN, be sure to set the IP address and subnet mask. When connecting to a network, ask the network administrator for the settings.

LAN Connection Examples

Connecting one PC and one instrument with a 9642 LAN Cable

Network Addresses : 192.168.1.0/24 (Private IP addresses)

Subnet Mask : 255.255.255.0

PC (The settings are made manually)

IP Address : 192.168.1.1

For a network as shown above, set the PC and the instrument's Comm screen as shown next.

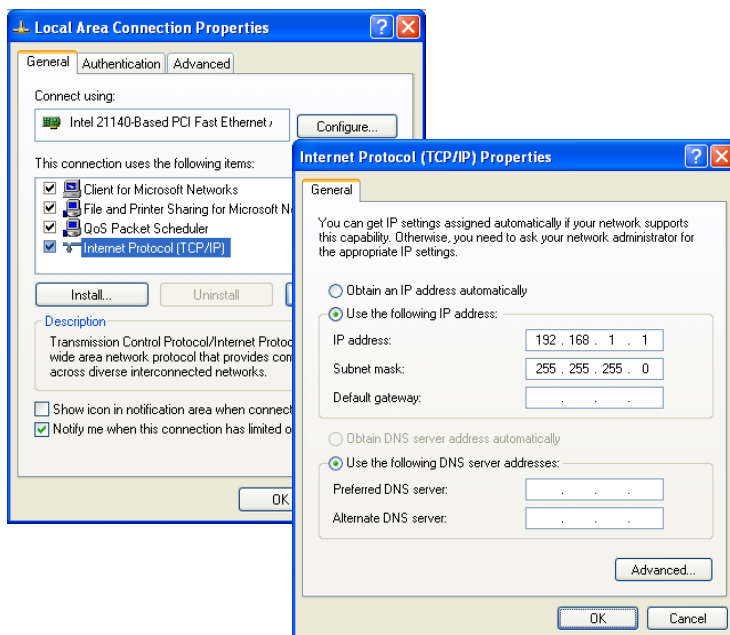

PC Settings

IP Address : 192.168.1.1
Subnet Mask : 255.255.255.0

The network settings on the PC are made in the **[Network]** dialog box. To get to this dialog box, double-click the **[Network]** icon in **[Control Panels]**.



Instrument Settings

Host Name : LOGGER*
DHCP : OFF
IP Address : 192.168.1.2
Subnet Mask : 255.255.255.0
Port Number : 880X
Gateway : OFF

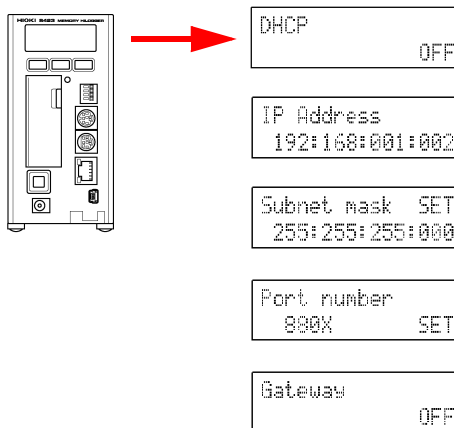

When connecting one PC and one instrument by the conversion connector of the 9642 LAN CABLE, the IP address can be specified arbitrarily, but there is no problem with using a private IP address.

Set the instrument as shown below, so that every instrument has a unique host name and IP address.

* If you set an IP address, it does not matter if a host name is not entered.

5.1 Registering Loggers in Logger Utility

Connecting one PC to multiple instrument's in a HUB.

Use a straight cable to connect the PC to the HUB and to connect the instrument to the HUB.

When building a local network with no outside connections, it is recommended that private IP addresses be used for the IP addresses.

Make the same settings on the PC as shown left. Set the IP address manually. Set the instrument as shown below, so that every instrument has a unique host name and IP address.

The first instrument (The settings are made manually)

Setting Items	Settings
Host Name	LOGGER1*
IP Address	192.168.1.2

The second instrument (The settings are made manually)

Setting Items	Settings
Host Name	LOGGER2*
IP Address	192.168.1.3

The third instrument (The settings are made manually)

Setting Items	Settings
Host Name	LOGGER3*
IP Address	192.168.1.4

Common settings

Setting Items	Settings
DHCP	OFF
Subnet Mask	255.255.255.0
Gateway	OFF
Port Number	880X

* If you set an IP address, it does not matter if a host name is not entered.

Communication Problems

Have you completed the LAN setting before connection?

The LAN setting is initialized when all the settings for communications have been made. Be sure to complete this LAN setting before you connect the instrument to the network. When you edit the settings while the instrument is connected to the network, you may accidentally send illegal address information to the network. For example, you may select the same IP address as that of another instrument on the network.

Is the LAN cable connected properly?

When you make one-to-one connection between the instrument and a PC, you must use a cross cable.

The short cable of the straight-cross converter supplied with the 9642 LAN CABLE is a cross cable. The connector is a straight male-female converter.

The cable might not be connected to the connector properly. Remove the cable and then connect it again.

Have you set the IP address of the PC correctly?

Choose **[Run]** from the Start menu. Type **[ipconfig /all]** and click **[Enter]**. Doing so will enable you to get the IP address of the PC's network interface, subnet mask, and gateway address.

When the IP address setting is not correct

Choose **[Settings]-[Control Panels]** from the Start menu.

Double-click the **[Network]** icon to get the Network Properties dialog box.

Edit the IP address setting.

Can the instrument communicate with the PC?

If the IP addresses of the instrument and the PC are correct, check to see whether the instrument receives signals from the PC using the ping protocol.

Choose **[Programs]-[Accessories]-[Command Prompt]** from the Start menu.

When the cursor starts blinking, type **[ping < IP address of the host you want to check >]**.

If the IP address can be obtained from DNS by providing the host name, you can type in the host name instead of the IP address.

For example, if the IP address of the instrument is 192.168.1.2, type **[ping 192.168.1.2]** and press Enter. If the screen display is as shown below, the instrument and the PC are communicating properly. "Time" represents how long it took for the instrument and the PC to communicate.

Pinging 192.168.1.2 with 32 bytes of data:

Reply from 192.168.1.2: bytes=32 time<10ms TTL=32

Reply from 192.168.1.2: bytes=32 time<10ms TTL=32

Reply from 192.168.1.2: bytes=32 time<10ms TTL=32

Reply from 192.168.1.2: bytes=32 time=1ms TTL=32

If the screen display is as shown above, the instrument and the PC are not communicating properly. Check the cable connection again.

Request timed out.

Request timed out.

Request timed out.

Request timed out.

Precautions on USB communication

To ensure safe transmission, disconnect all USB devices except the Memory HiLogger from the PC before carrying out measurement with the Logger Utility.

Do not unplug the USB cable of the Memory HiLogger or switch off the power during measurement. Communication from the Logger Utility will be interrupted (this applies even to loggers which are not measuring when multiple sets of Memory HiLoggers are connected).

Note) Communication may be interrupted, but the Memory HiLogger will continue to carry out measurement.

If you have accidentally switched off the power to interrupt the communication, re-connect the Memory HiLogger which cannot be communicated.

5.1.3 Settings for Synchronized Measurement

If you use special 9683 Connection Cables, it is possible to measure with the sampling of multiple loggers synchronized. You can set a master to be the reference for sampling (base), and measure with up to five loggers synchronized. With synchronized measurement, it is possible to perform measurement in which a trigger is used among multiple loggers.

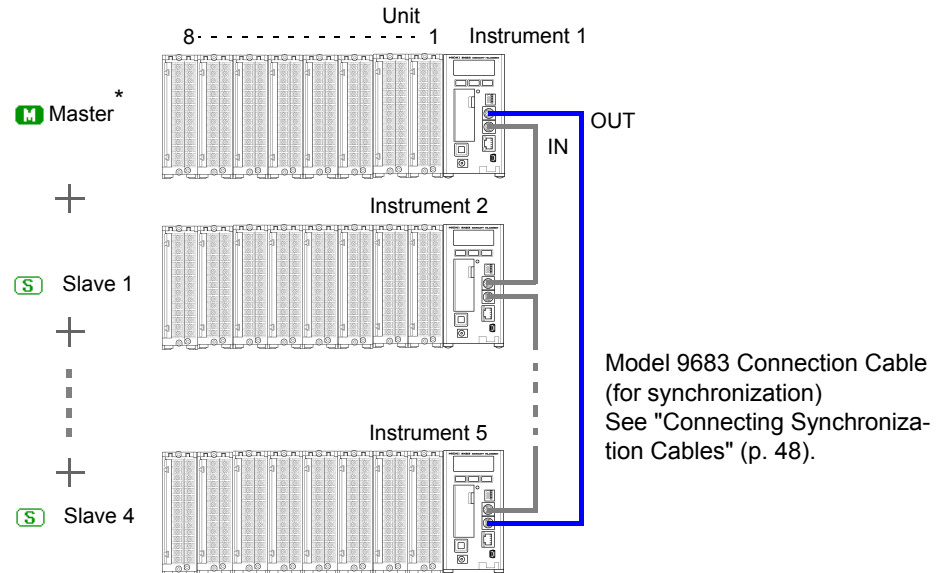

1. On the connection settings page, search and register or manually register the loggers for measurement.
2. Add a check to **[Synchronized Measurement]** to enable synchronized measurement. A check cannot be added if only one logger is registered.
3. Set the logger to be the reference for sampling (master).

M : Master **S** : Slave

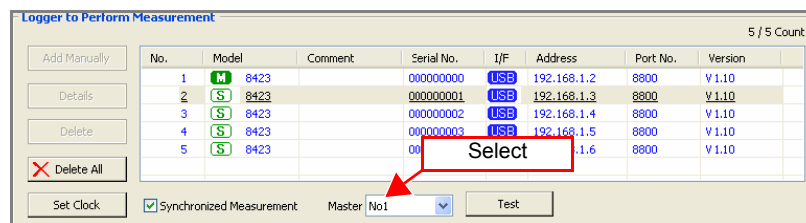

4. Click the **[Test]** button to display the synchronization test result.

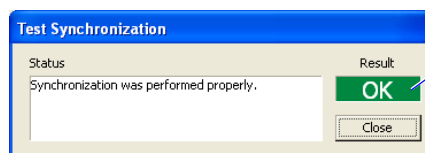

Synchronization test result
 OK: The loggers are connected properly.
 NG: Check the connections of the 9683 Connection Cables according to the status.

NOTE

- Always connect the 9683 Connection Cables when synchronized measurement will be performed. Furthermore, do not connect 9683 Connection Cables if there are six or more loggers. The loggers will not work properly.
- Synchronized measurement is not possible with only one logger.
- The trigger setting is invalid when synchronized measurement is not performed.

5.2 Confirming the Unit Configuration (Digital Filter Setting)

This section describes confirming the configuration of units attached to a logger and setting the digital filter on the unit configuration page. When dual sampling is set, also set the recording interval of each unit. If you set the digital filter, it is possible to eliminate noise superimposed on an input signal. The longer the recording interval is, the greater the effect of noise reduction. For the relation between the recording interval and cutoff frequency, see "12.3.1 Model 8948 Voltage/Temp Unit" (p. 221) and "Recording Interval and Cutoff Frequency Table" of "12.3.2 Model 8949 Universal Unit" (p. 223).

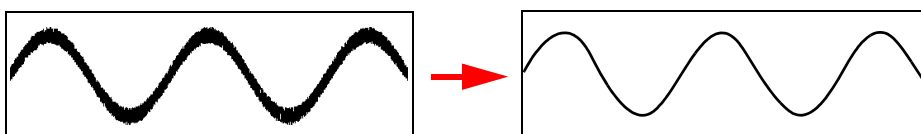

NOTE

- If the digital filter is set to 50 Hz or 60 Hz, the scanning time of each channel becomes almost as long as the time for obtaining all channel data within the recording interval. If the digital filter setting is OFF, the scanning time becomes approximately 10 ms.
- The digital filter is available for the measurement of voltage, temperature, and humidity. It is not available for logic, pulse, and alarm channels.

When a Logger is Registered by Searching

When a logger is registered by searching on the connection settings page, the instrument information is obtained automatically from the logger and then the unit configuration is displayed.

1. Confirm that the unit configuration shown on the unit configuration page matches the actual content.
2. Set the digital filter.

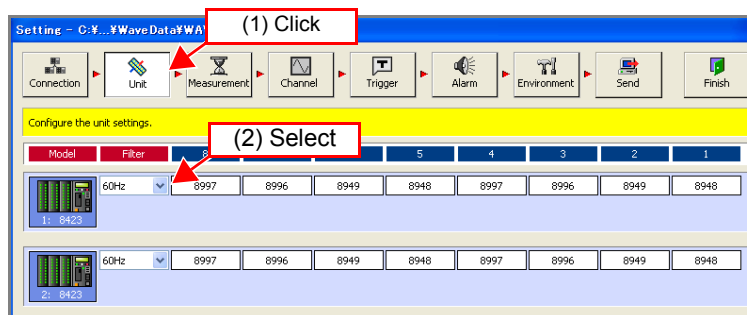

Selectable Items	Explanations
OFF	The filter is not used.
50 Hz	Select this to use at an operating power frequency of 50 Hz.
60 Hz	Select this to use at an operating power frequency of 60 Hz.

When a Logger is Registered Manually or When Changing the Unit Configuration after Searching and Registering

When a logger is registered manually on the connection settings page, you can also set the unit configuration manually. Furthermore, if you have changed the unit configuration of a logger since it was registered, change the unit configuration displayed in the screen.

1. Click the icon of a logger in the unit configuration page to switch the background color from blue to red and enable the unit to be changed.
2. Select a unit from the list.

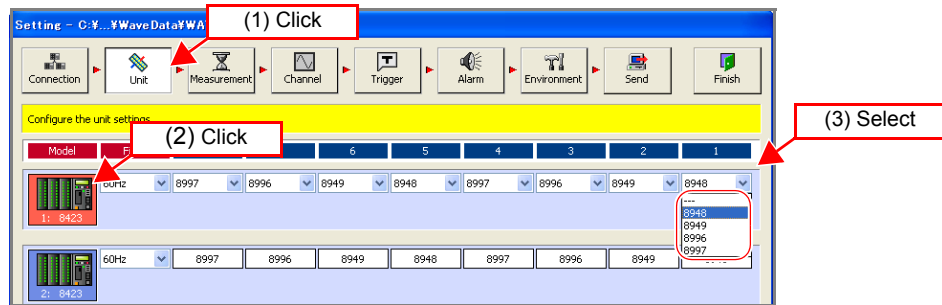

Selectable Items	Explanations
---	No unit
8948	Voltage/Temp Unit (Voltage and Thermocouple)
8949	Universal Unit (Voltage, Thermocouple, Resistance temperature detector, and Humidity)
8996	Digital/Pulse Unit (Logic input and Pulse input)
8997	Alarm Unit (Alarm output)

3. Click on the logger icon to change the background color from red to blue and confirm the unit changes.
4. Set the digital filter.

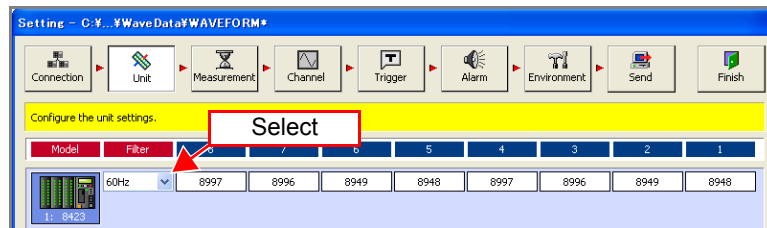

Selectable Items	Explanations
OFF	The filter is not used.
50Hz	Select this to use at an operating power frequency of 50 Hz.
60Hz	Select this to use at an operating power frequency of 60 Hz.

NOTE

- Register each unit in order from the right. It is not possible to leave a space between each unit when you configure the setting.
- Make the unit configuration the same as the actual unit configuration of the logger. Measurement will not be possible if the configurations do not match.
- If you select no unit "---," any unit to the left side of that will be disabled.
- Attach at least one unit other than the 8997 Alarm Unit to this instrument. If all of the units are 8997 Alarm Units, measurement will not be performed properly.

5.3 Configuring Basic Settings for Measurement

This section describes configuring basic settings for measurement such as the recording interval (sampling speed) and recording period. The screen settings differ depending on the sampling function you select.

5.3.1 Setting Function and Recording Interval

On the measurement settings page, select the sampling function in accordance with the purpose of measurement. The method for obtaining measurement data, settings, and available functions differ depending on the sampling function. Sampling cannot be set for the 8997 Alarm Unit.

Normal Sampling

Sampling is performed at a timing which is synchronized to the internal clock of the logger, and the data is recorded. The measurement data quantity is the same for all channels.

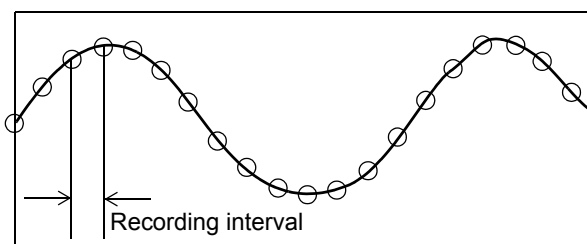

1. Click **[Normal Sampling]** on the measurement settings page.
2. Set the recording interval (high-speed).

Selectable Intervals
10, 20, 50, 100, 200, 500 ms, 1, 2, 5, 10, 20, 30 s, 1, 2, 5, 10, 20, 30 m, 1 h

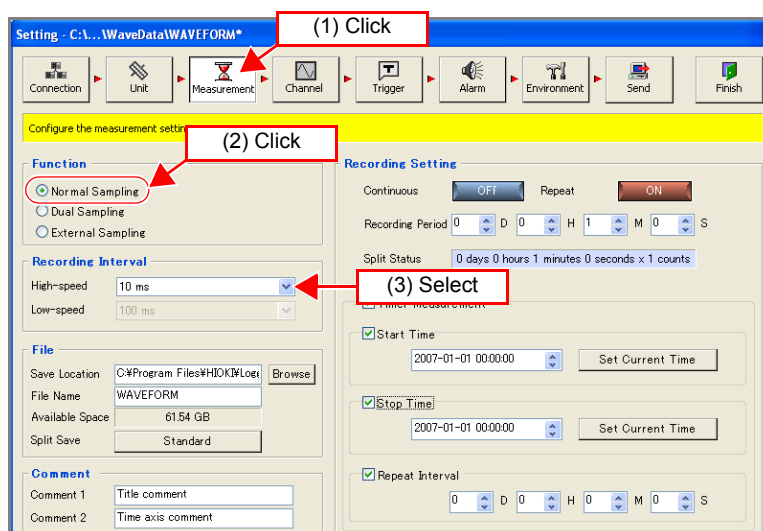

Dual Sampling

Since it is possible to set dual sampling intervals, you can measure with the measurement interval suitable for each measurement object. This enables the effective use of internal memory and CF card space. The measurement data quantity differs depending on the specified recording interval (high-speed or low-speed). Select the recording interval for each unit.

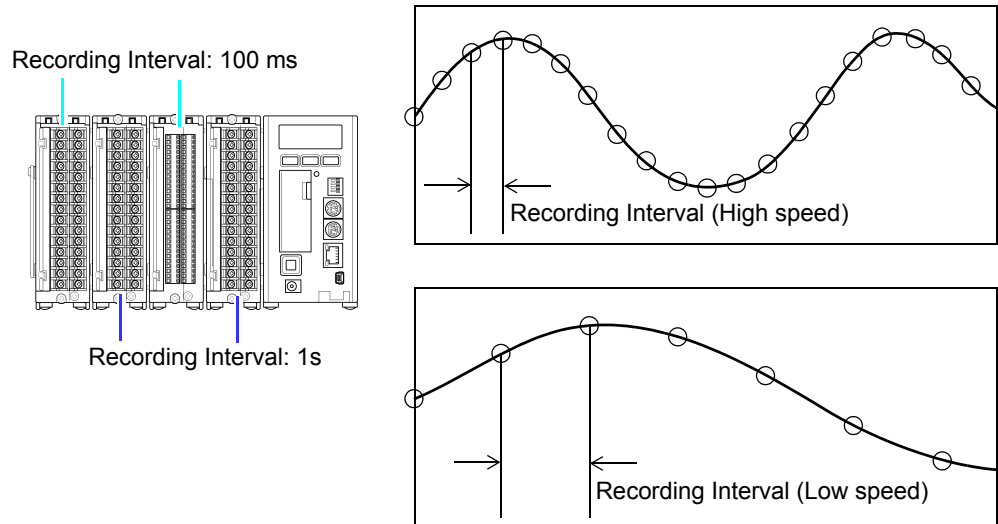

Possible Combination of High-speed Sampling and Low-speed Sampling Settings

The following table shows the combination of recording intervals that can be set when the function is dual sampling.

Low-speed High-speed	10 ms	20 ms	50 ms	100 ms	200 ms	500 ms	1 s	2 s	5 s	10 s	20 s	30 s	1 m	2 m	5 m	10 m	20 m	30 m	1 h
10 ms	—	—	—	1	1	1	1	1	1	1	—	—	—	—	—	—	—	—	—
20 ms	—	—	—	1	1	1	1	1	1	1	1	—	—	—	—	—	—	—	—
50 ms	—	—	—	1	1	1	1	1	1	1	1	1	—	—	—	—	—	—	—
100 ms	—	—	—	1	1	1	1	1	1	1	1	1	1	—	—	—	—	—	—
200 ms	—	—	—	—	1	—	1	1	1	1	1	1	1	1	—	—	—	—	—
500 ms	—	—	—	—	—	1	1	1	1	1	1	1	1	1	1	—	—	—	—
1 s	—	—	—	—	—	—	1	1	1	1	1	1	1	1	1	1	—	—	—
2 s	—	—	—	—	—	—	—	1	—	1	1	1	1	1	1	1	1	1	—
5 s	—	—	—	—	—	—	—	—	1	1	1	1	1	1	1	1	1	1	1
10 s	—	—	—	—	—	—	—	—	—	1	1	1	1	1	1	1	1	1	1
20 s	—	—	—	—	—	—	—	—	—	—	1	—	1	1	1	1	1	1	1
30 s	—	—	—	—	—	—	—	—	—	—	—	1	1	1	1	1	1	1	1
1 m	—	—	—	—	—	—	—	—	—	—	—	—	1	1	1	1	1	1	1
2 m	—	—	—	—	—	—	—	—	—	—	—	—	—	1	—	1	1	1	1
5 m	—	—	—	—	—	—	—	—	—	—	—	—	—	—	1	1	1	1	1
10 m	—	—	—	—	—	—	—	—	—	—	—	—	—	—	—	1	1	1	1
20 m	—	—	—	—	—	—	—	—	—	—	—	—	—	—	—	—	1	—	1
30 m	—	—	—	—	—	—	—	—	—	—	—	—	—	—	—	—	—	1	1
1 h	—	—	—	—	—	—	—	—	—	—	—	—	—	—	—	—	—	—	1

1: can be set, —: can be not set

1. Click [Dual Sampling] on the measurement settings page.
2. Set the recording interval.
(on each of the high-speed and low-speed)

Selectable Intervals
10, 20, 50, 100, 200, 500 ms, 1, 2, 5, 10, 20, 30 s, 1, 2, 5, 10, 20, 30 m, 1 h

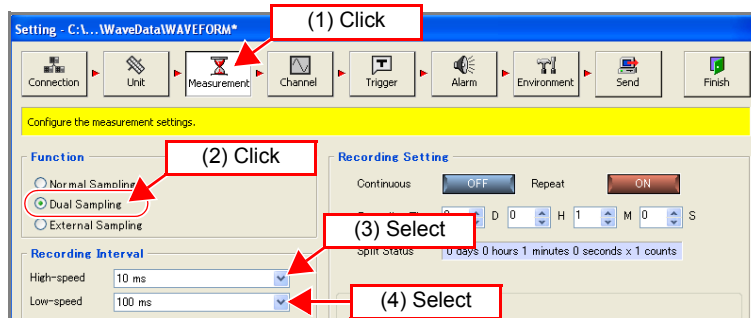

5.3 **Configuring Basic Settings for Measurement**

- Return to the unit configuration page and set the recording interval for each unit.
Each click of the button switches whether the recording interval is in the group for high speed or low speed.

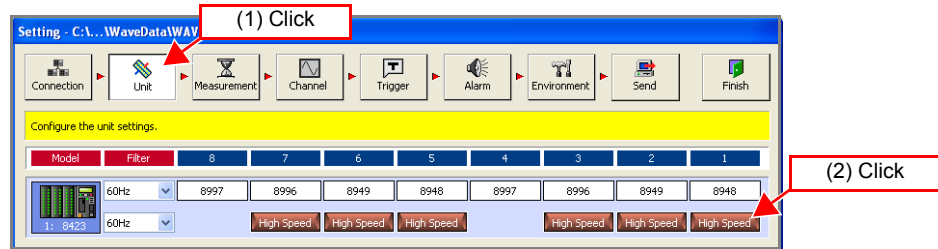

When simultaneously measuring different physical quantities, you can reduce the amount of data compared with measuring using normal sampling by selecting "High Speed" for high-speed phenomena such as voltage, and selecting "Low Speed" for capturing phenomena with gentle variations such as temperature and humidity.

- Set the digital filter for each of the high-speed and low-speed. (p. 75)

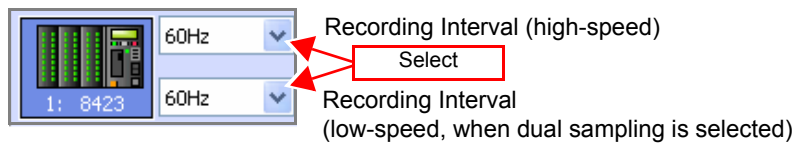

Selectable Items	Explanations
OFF	The filter is not used.
50Hz	Select this to use at an operating power frequency of 50 Hz.
60Hz	Select this to use at an operating power frequency of 60 Hz.

NOTE

- The sampling speed becomes slower on the low-speed side than the high-speed side.
- The maximum value for the sampling ratio of the high-speed side and the low-speed side is 1000 times. It is not possible to set recording intervals that exceed this ratio.
- Data of the high-speed side does not appear on the screen until scanning of the low-speed side ends. The scanning time differs depending on the recording period when the digital filter is not OFF, and becomes up to approximately 16 seconds longer. When the digital filter is OFF, the scanning time is 10 ms regardless of the recording interval. (p. 75)
- The sampling data is the data at the scanning start time regardless of the scanning time.

External Sampling

Sampling is synchronized to the timing of the clock input from an external control input terminal on the front of the instrument, and data is recorded. The measurement data quantity is the same for all channels. A recording interval cannot be set.

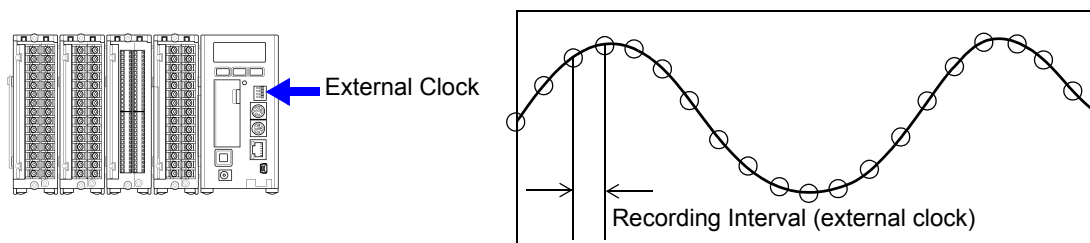

1. Click [External Sampling] on the measurement settings page.

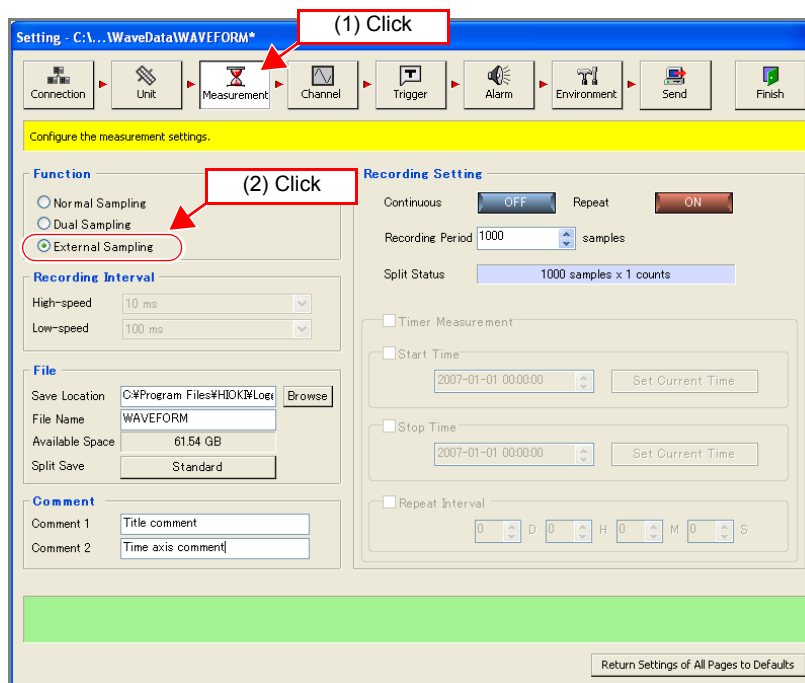

NOTE

- Set the clock provided from an external device to no more than 100 Hz. It is not possible to respond to a clock which is faster than that.
- For measurement in which a 9701 Humidity Sensor or digital filter is used, it is not possible to record data with a recording interval for which the clock is less than 5 seconds.
- The following table shows the maximum response speeds when external sampling is set.

Maximum Sampling Speed	Filter OFF	50 Hz	60 Hz
No humidity measurement	10 ms/S *	5 s/S	5 s/S
Humidity measurement	5 s/S	5 s/S	5 s/S

* The maximum sampling speed for when performing synchronized measurement is 20 ms/S.

5.3.2 File Save Settings

This section describes setting the save location and save method for measurement data.

1. Click the **[Browse]** button on the measurement settings page to display the **[Browse for Folder]** dialog box.
2. Specify a file save location, and then click the **[OK]** button.

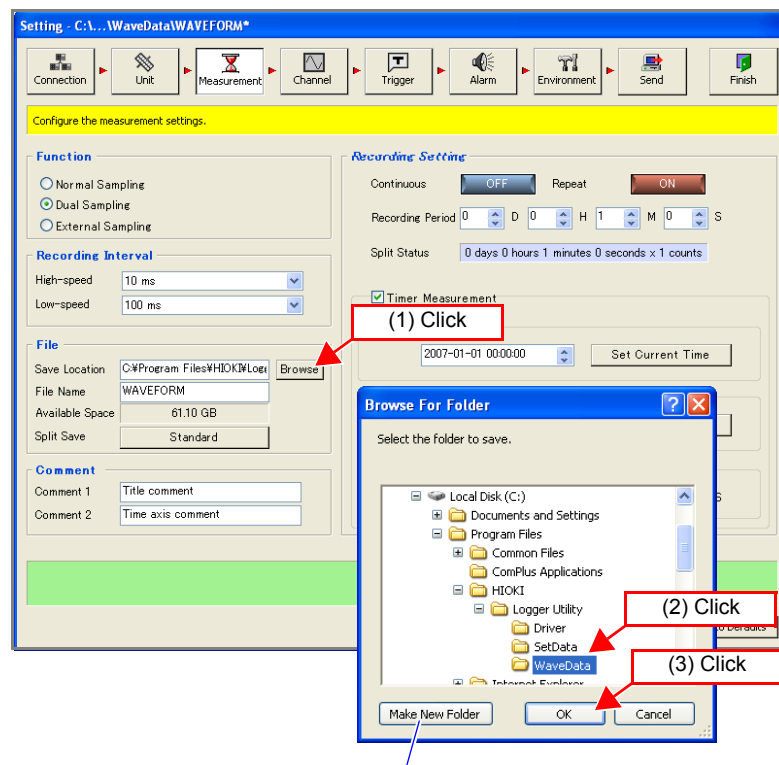

This button creates a folder under the directory currently selected in the list.

3. Enter the save file name.

4. Set divisible saving. Click the [Standard] button to display the [Folder Split Settings] dialog box. Set the file save method.

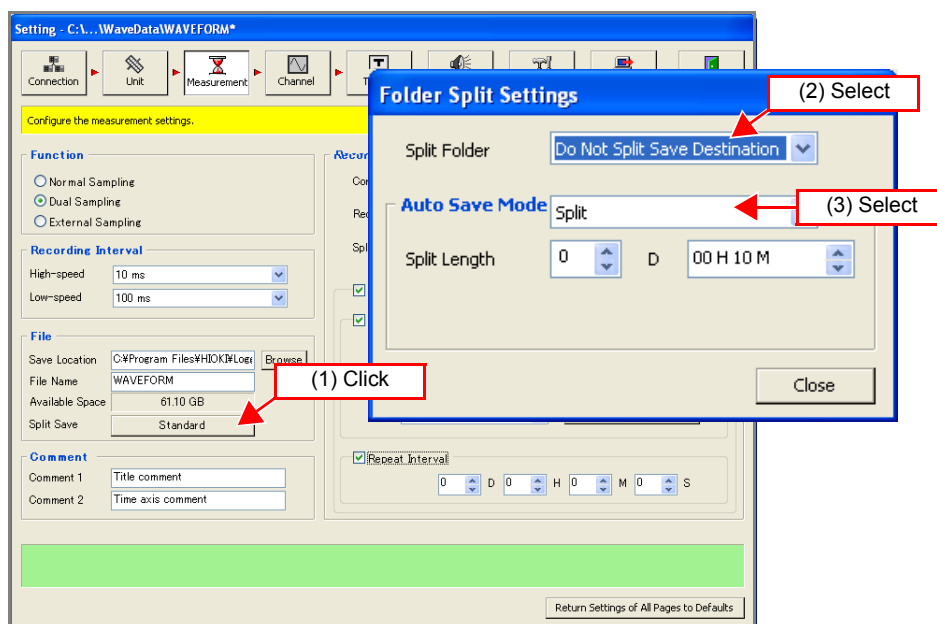

Split Folder (This setting is for saving with only the Logger Utility)

Selectable Items	Explanations
Do Not Split Save Destination	Saves files to the save location.
Split Each Day	Creates the sub-folder "YYYYMMDD" in the save location, and saves files in that sub-folder.
Split Each Week	Creates the sub-folder "YYYYMMDD" in the save location, and saves files in that sub-folder.
Split Each Month	Creates the sub-folder "YYYYMM" in the save location, and saves files in that sub-folder.
Split Each Year	Creates the sub-folder "YYYY" in the save location, and saves files in that sub-folder.

YYYY: Year (2000 to 2999), MM: Month (01 to 12), DD: Day (01-31)

Auto Save Mode (This setting is for saving with both the instrument and Logger Utility)

Selectable Items	Explanations
Standard	Creates one file per measurement.
Split	Splits the data at regular intervals from the start of measurement, and creates separate files. Set the split length. Setting range: 0 day, 0 hour, 1 minute to 30 days, 23 hours, 59 minutes
Split at Regular Intervals	Allows a reference time to be set within a 24 hour period, splits data at regular intervals from that reference time, and creates separate files. Set both the split time (data split interval) and reference time (data split reference time).

The auto save mode is not available when external sampling is set.

5.3 Configuring Basic Settings for Measurement

5.3.3 Comment Input

The comments that appear on the main screen can be set. Comments are effective for managing measurement data because you can enter whatever you want. A character string is displayed in the upper part of the main screen for Comment 1, and a character string is displayed in the lower part of the main screen for Comment 2.

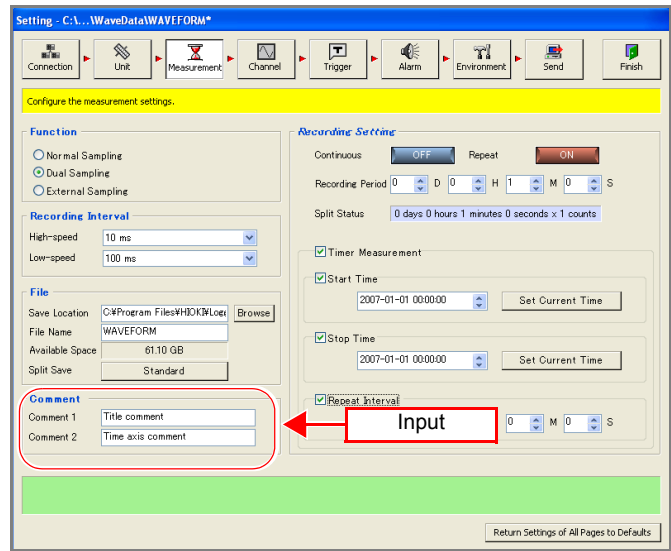

Waveform Display Area Comment 1

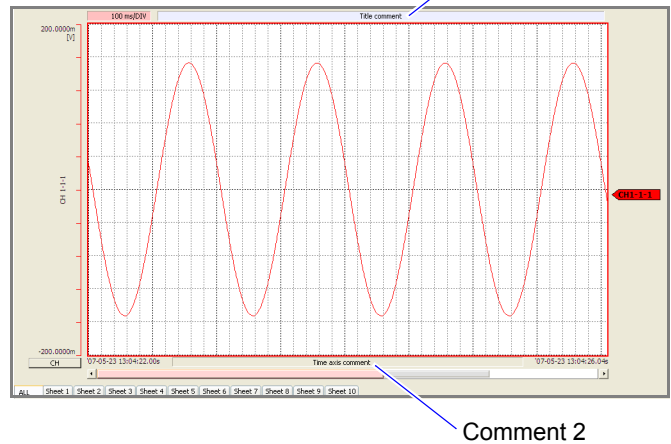

You can enter up to 80 characters for a comment.

5.3.4 Recording Settings

The following three types of recording method are available. It is also possible to measure in combination with timer measurement in order to specify a measurement start time and stop time. Make sure the current time of the computer is correct before you configure this setting.

Types of Recording	Explanations
Normal Recording	Measures from the start of measurement for the set recording period.
Continuous Recording	Measures continuously from the start of measurement.
Repeat Recording	Measures while splitting data each recording period.

Triggers are ignored during recording operation. For the relation between timer measurement and triggers, see "5.5.1 Recording Operation during Simultaneous Use of Timer Measurement and Triggers" (p. 105).

Normal Recording

1. On the measurement settings page, set **[Continuous]** (continuous recording) and **[Repeat]** (repeat recording) to OFF, and set the recording period. Each click of the button toggles the setting ON and OFF.

In the case of normal sampling and dual sampling

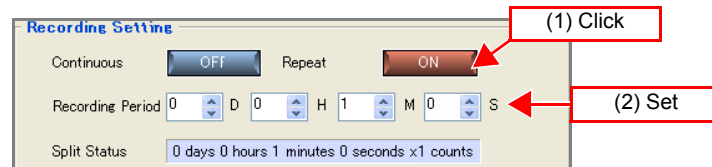

In the case of external sampling

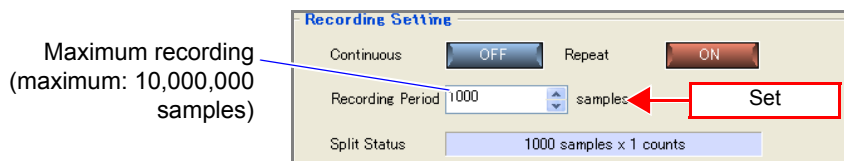

2. Start measurement to measure for the set recording period. If the **[Stop]** button is pressed before the recording period has elapsed, measurement ends.

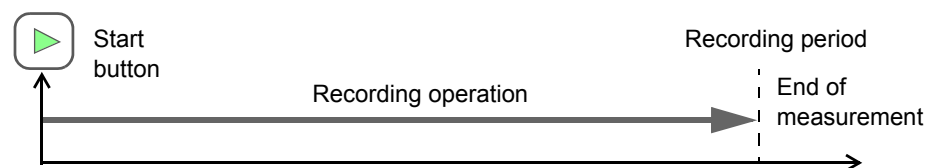

5.3 Configuring Basic Settings for Measurement

Maximum Recording Period for Each Recording Interval

Recording Interval (High-speed)	Maximum Recording Period	Recording Interval (High-speed)	Maximum Recording Period	Recording Interval (High-speed)	Maximum Recording Period
10 ms	1 day	1 s	100 days	1 m	500 days
20 ms	2 days	2 s	200 days	2 m	500 days
50 ms	5 days	5 s	500 days	5 m	500 days
100 ms	10 days	10 s	500 days	10 m	500 days
200 ms	20 days	20 s	500 days	20 m	500 days
500 ms	50 days	30 s	500 days	30 m	500 days
				1 h	500 days

Continuous Recording

Measure continuously without specifying a recording period.

1. Set **[Continuous]** on the measurement settings page to **ON**. Each click of the button toggles the setting ON and OFF.

In the case of normal sampling and dual sampling

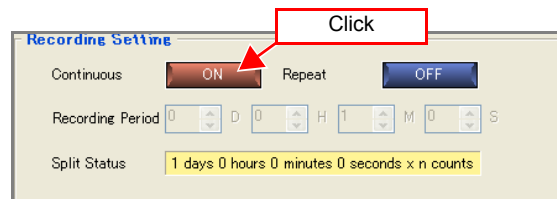

2. Start measurement to measure continuously until measurement is stopped.

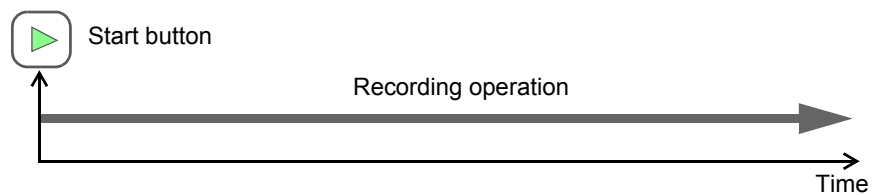

(Stop trigger, when repeat recording is ON)

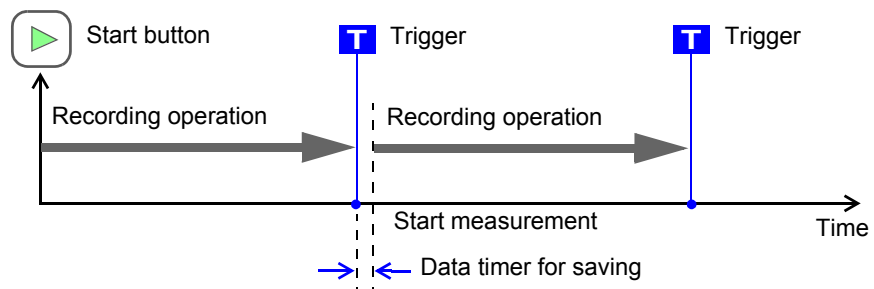

Repeat Recording

Measure while splitting data each recording period.

1. Set **[Repeat]** on the measurement settings page to ON. Each click of the button toggles the setting ON and OFF.
2. Set the recording period.

In the case of normal sampling and dual sampling

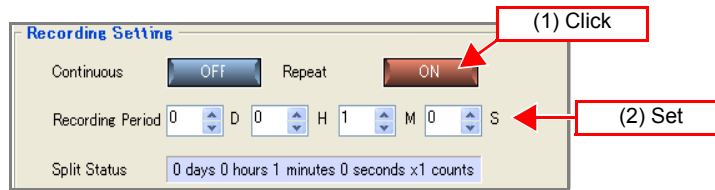

In the case of external sampling

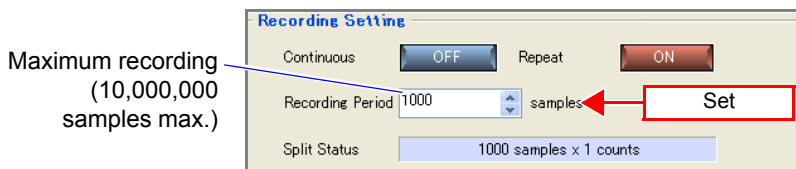

3. Start recording to measure data for the recording period length repeatedly until measurement is stopped.

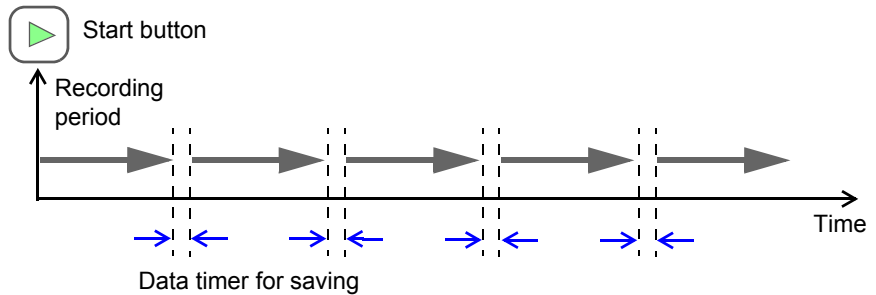

If you set a repeat measurement interval for timer measurement, it is possible to repeat measurement while leaving a gap at a fixed interval as shown in the figure below.

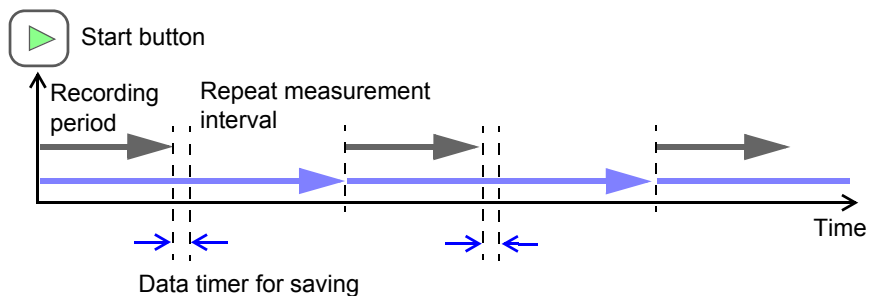

Timer Measurement

The start time and stop time of measurement can be specified. If you combine timer measurement and repeat measurement, measurement such as the following is possible. Specify a measurement start time and a measurement stop time, and measure data from 9:00 to 17:00 every day during the period of January 1, 2007, to January 10, 2007.

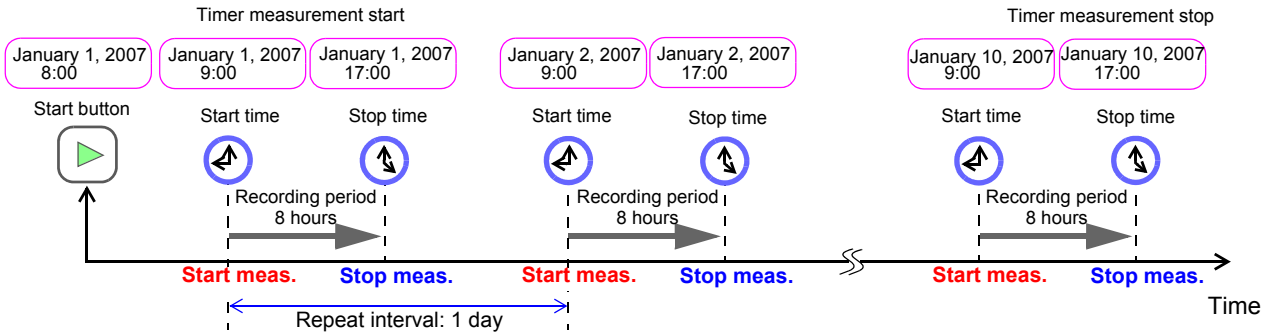

1. On the measurement settings page, set **[Continuous]** (continuous recording) to OFF and **[Repeat]** (repeat recording) to ON, and set the recording period.
2. Add a check to **[Timer Measurement]**. Each click of the check box toggles timer measurement ON and OFF. In the case of normal sampling and dual sampling

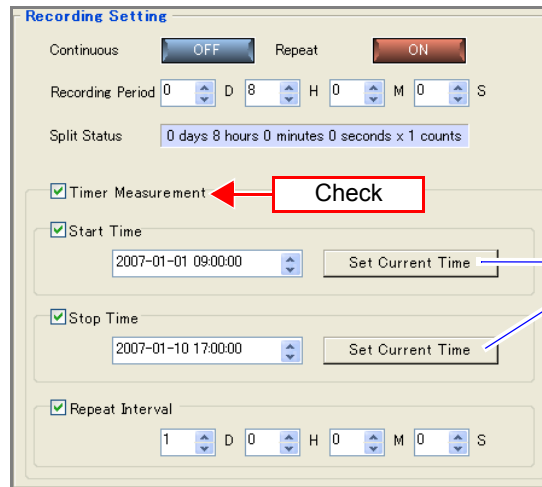

These allow you to set the current time of the computer.

3. To set a measurement start time, add a check to **[Start Time]** and set a time. You can use the [← →] left and right arrow keys on the keyboard to move to an input item, and the [↑ ↓] up and down arrow keys to increase and decrease the value.
4. To set a measurement stop time, add a check to **[Stop Time]** and set a time.
5. To set a repeat measurement interval time, add a check to **[Repeat Interval]** and set a time.
6. Click the  button. Then the measurement starts and stops when the specified conditions are satisfied.

NOTE

If timer measurement is set to OFF, the measurement start time, measurement stop time, and repeat measurement interval are disabled.

5.4 Advanced Settings for Each Channel

This section describes setting measurement conditions such as input type and range, and display settings such as display color and sheet assignment for each channel.

5.4.1 Setting Measurement Conditions

Configure settings such as the input type, range, and comment of each channel on the measurement settings page.

1. Select the channel for measurement on the measurement settings page of the channel settings.

Each click of the [Measurement] button toggles measurement ON and OFF.

Narrowing down of display channels (p. 129)

: Measurement ON

Copy the channel setting information to another channel. (p. 128)

Channel	Address	Unit	Input Type	Range	Resolution
1-1-1	8948	Voltage/Temper...	Voltage	100 mV F.s.	
1-1-2	8948	Voltage/Temper...	Voltage	100 mV F.s.	
1-1-3	8948	Voltage/Temper...	Voltage	100 mV F.s.	
1-1-4	8948	Voltage/Temper...	Voltage	100 mV F.s.	
1-1-5	8948	Voltage/Temper...	Voltage	100 mV F.s.	
1-1-6	8948	Voltage/Temper...	Voltage	100 mV F.s.	
1-1-7	8948	Voltage/Temper...	Voltage	100 mV F.s.	
1-1-8	8948	Voltage/Temper...	Voltage	100 mV F.s.	
1-1-9	8948	Voltage/Temper...	Voltage	100 mV F.s.	
1-1-10	8948	Voltage/Temper...	Voltage	100 mV F.s.	
1-1-11	8948	Voltage/Temper...	Voltage	100 mV F.s.	
1-1-12	8948	Voltage/Temper...	Voltage	100 mV F.s.	
1-1-13	8948	Voltage/Temper...	Voltage	100 mV F.s.	
1-1-14	8948	Voltage/Temper...	Voltage	100 mV F.s.	
1-1-15	8948	Voltage/Temper...	Voltage	100 mV F.s.	

2. Set the input type.

Select

Comment input field (entering up to 40 characters is optional)

3. Configure various settings in accordance with the input type.

For details, see the sections from the next page onwards.

When Voltage is Selected

Measurement is possible when an 8948 Voltage/Temp Unit or 8949 Universal Unit is connected. Set the range.

Selectable Items	Measurable Ranges	Maximum Resolution
100 mV f.s.	-150 to 150 mV	5 μ V
1 V f.s.	-1.5 to 1.5 V	50 μ V
10 V f.s.	-15 to 15 V	500 μ V
20 V f.s.	-30 to 30 V	1 mV
100 V f.s.	-100 to 100 V ^{*1}	5 mV
1-5 V f.s. ^{*2}	1 to 5 V	500 μ V

*1: The range for the 8949 Universal Unit is -60 to 60 V.

*2: The 1-5 V f.s. range for voltage measurement is intended for use with measurement devices that provide an output of 1-5 V at 4-20 mA. The upper limit 5 V and the lower limit 1 V of the 10 V f.s range is set automatically. The measurement accuracy is the same as for 10 Vf.s. When inputting a 4-20 mA electric current, connect a 250 Ω resistance as a shunt resistance across the + and - analog input terminals. See "3.2.2 Connecting a Cable" (p. 37).

When Thermocouple is Selected (Temperature Measurement)

Measurement is possible when an 8948 Voltage/Temp Unit or 8949 Universal Unit is connected. Set the range, type of thermocouple, reference junction compensation, and burn out detection.

Range

Selectable Items	Measurable Ranges	Maximum Resolution
100°C f.s.	-100 to 100°C	0.01°C
500°C f.s.	-200 to 500°C	0.05°C
2000°C f.s.	-200 to 2000°C	0.1°C

Thermocouple

(the ranges that can be selected differ depending on the type)

Items	Measurable Ranges	Items	Measurable Ranges	Items	Measurable Ranges
K	-200 to 1350°C	J	-200 to 1200°C	E	-200 to 1000°C
T	-200 to 400°C	N	-200 to 1300°C	R	0 to 1700°C
S	0 to 1700°C	W	0 to 2000°C	B	0 to 1800°C

RJC (Reference junction compensation format)

Selectable Items	Explanations
Internal	Performs reference junction compensation within the instrument. Measurement accuracy is the sum of temperature measurement accuracy and reference junction compensation accuracy.
External	Does not perform reference junction compensation within the instrument. Select this setting when using an external device to perform reference junction compensation. Measurement accuracy is equivalent to temperature measurement accuracy.

Burn Out

Selectable Items	Explanations
ON	Enables burn out detection. If a wire is broken, a reading that is off the scale is displayed at the top of the main screen, and +OVER appears in the list display area. A broken wire is detected by applying a very small current of approximately 400 nA to the thermocouple. If a thermocouple that is long or has a large resistance is used, measurement errors may occur. In such a case, use the thermocouple with burn out detection OFF when taking measurements of high-accuracy.
OFF	Disables burn out detection. When the thermocouple is burn out, the value is usually unstable or undecided.

NOTE

Only when the recording interval falls within 100 ms to 1h, and the digital filter is set at 50Hz/60Hz can the **[Burn Out]** be set to **[ON]**.

When Resistance Temperature Detector is Selected (Temperature Measurement)

Measurement is possible when an 8949 Universal Unit is connected. Set the range, type of resistance temperature detector, and connection type.

Range

Selectable Items	Measurable Ranges	Maximum Resolution
100°C f.s.	-100 to 100°C	0.01°C
500°C f.s.	-200 to 500°C	0.05°C
2000°C f.s.	-200 to 2000°C	0.1°C

Type of resistance temperature detector

Selectable Items	Measurable Ranges
Pt100	-200 to 800°C
JPt100	-200 to 500°C

Connection type

Selectable Items	Explanations
3-wire	Connect a 3-wire measurement resistance detector.
4-wire	Connect a 4-wire measurement resistance detector.

When Humidity is Selected

Measurement is possible when an 8949 Universal Unit is connected and a 9701 Humidity Sensor is connected to the 8949 Universal Unit. The range is fixed to 100%f.s.

NOTE

If humidity is selected for even one of the channels, the recording interval can only be set to a setting longer than 5 seconds because the sensor response speed is limited. If a recording interval of less than 5 seconds is selected, it is automatically changed to 5 seconds.

When Pulse is Selected (Totalized Pulse Measurement)

Measurement is possible when an 8996 Digital/Pulse Unit is connected. Set the mode, chattering prevention, count mode (pulse/rotation rate), slope, and threshold value. A range cannot be selected. It is fixed to 1000 Mcf.s. (measurable range: 0 to 1000 M pulses) when count mode is selected, and automatically selected in accordance with the setting for the number of pulses per rotation when revolve mode is selected. If the scaling function is used, it is possible to convert to the physical quantity for measurement.

Mode

Selectable Items	Explanations
Count	Totalizes and measures the number of pulses output from an integrating wattmeter, flowmeter, etc.
Revolve	Measures the pulses output according to the rotation rate of a rotary encoder, rotation meter, etc. The rotation rate is obtained by counting the number of pulses input for a one-second period.

Chattering prevention filter

Selectable Items	Explanations
ON	Enables use of the chattering prevention filter. Use this filter when connecting a device with a mechanical contact output.
OFF	Disables use of the chattering prevention filter.

Count mode (only settable when count is selected as the mode)

Selectable Items	Explanations
Add	Measures the totalization value from the start of measurement.
Instantaneous	Sets the instantaneous value for each recording interval. The instantaneous value is reset for each recording interval.

Pulse/rotation rate (only settable when revolve is selected as the mode)

Selectable Items	Measurable range
n = 1 to 1000	0 to 5000/n r/s f.s. (n is the number of pulses per rotation)

Slope

Selectable Items	Explanations
↑	Totalizes the number of times the pulse transitions from LOW to HIGH.
↓	Totalizes the number of times the pulse transitions from HIGH to LOW.

Threshold (threshold value of the pulse detection level)

Selectable Items	Explanations
1 V	Sets the threshold value to 1 V.
4 V	Sets the threshold value to 4 V.

Measuring Pulses (Rotation Rate)

The instrument measures the pulses output according to the rotation rate of a rotary encoder, rotation meter, etc. The rotation rate is obtained by counting the number of pulses input for a one-second period. Use of the scaling function enables converting the measured rotation rate to the physical quantity of the measurement object to perform measurement.

Measurement Principle of the Rotation Rate

When the range is set to "Rotation Rate," the number of pulses is totalized internally every 10 ms.

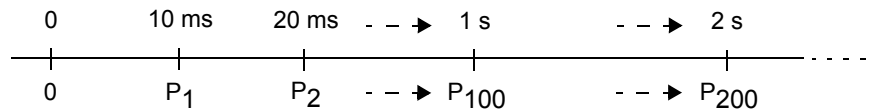

The rotation rate r at time t [s] is calculated by dividing the number of pulses from $(t-1)$ to t [s] by the number of pulses per rotation.

$$r = \frac{\text{Totalized number of pulses at } t \text{ [s]} - \text{totalized number of pulses at } (t-1) \text{ [s]}}{\text{Pulse / Rotation rate}} \text{ [rps]}$$

Example: Pulses per rotation = 4

When 1 s, totalized number of pulses $P_{10} = 1000$ counts

When 2 s, totalized number of pulses $P_{20} = 2000$ counts

In this case, the rotation rate $r_{t=2}$ for $t = 2$ s is calculated as follows:

$$r_{t=2} = \frac{2000 - 1000}{4} = 250 \text{ [rps]}$$

When time t [s] < 1 second

The totalized number of pulses of $t-1$ [s] is not measurable, so the value that is a hundred times the totalized number of pulses between $t-0.01$ [s] and t [s] is calculated as the totalized number of pulses during 1 s in order to calculate the rotation rate. For this reason, the rotation rate when t is less than 1 second may vary.

$$r = \frac{(\text{Totalized number of pulses at } t \text{ [s]} - \text{totalized number of pulses at } (t-0.01) \text{ [s]})}{\text{Pulse / Rotation rate}} \times 100 \text{ [rps]}$$

When Logic is Selected

Measurement is possible when an 8996 Digital/Pulse Unit is connected. Set the chattering prevention filter and threshold.

Chattering prevention filter

Selectable Items	Explanations
ON	Enables use of the chattering prevention filter. Use this filter when connecting a device with a mechanical contact output.
OFF	Disables use of the chattering prevention filter.

Threshold (threshold value of the pulse detection level)

Selectable Items	Explanations
1 V	Sets the threshold value to 1 V.
4 V	Sets the threshold value to 4 V.

5.4.2 Waveform Calculation Settings

The measured data is calculated with preset arithmetic expression to display the waveform. (Calculation is allowed during or after measurement)
 Four arithmetic operations (+, -, * and /) are employed between channels. Calculation is allowed for calculation channel.

1. Click **[Wave Calculation]** tab.
2. Click **[ON]** button to turn on **[Calculate Function]**.
 Each click of the button switches between ON and OFF.
3. Select the channel to calculate.
4. Click **[ON]** button to turn on **[Calculate]**.
 Each click of the button switches between ON and OFF.

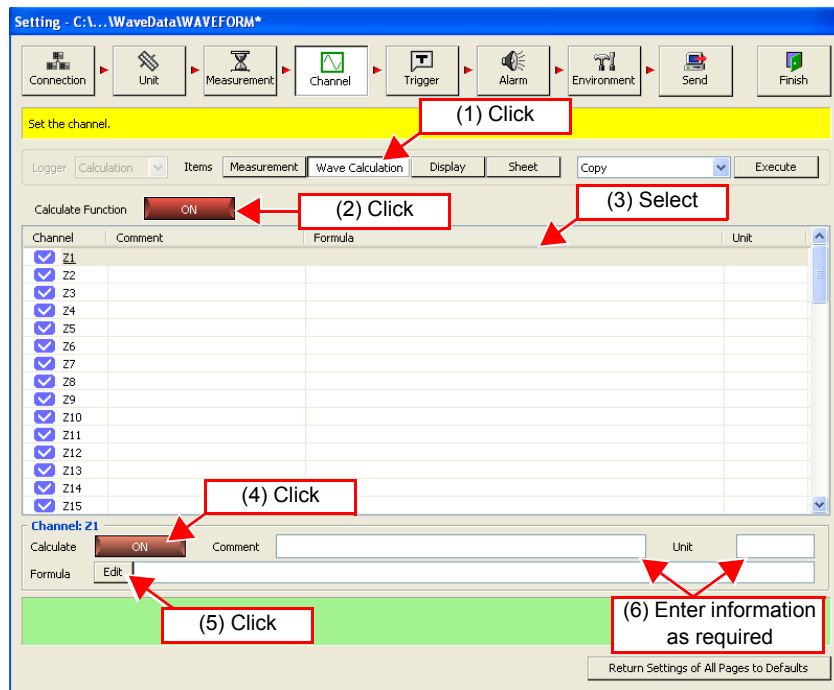

5. Click **[Edit]** button to display dialog box. Preset arithmetic expression and click **[Enter]** button.
 Up to 80 characters are allowed for arithmetic expression.

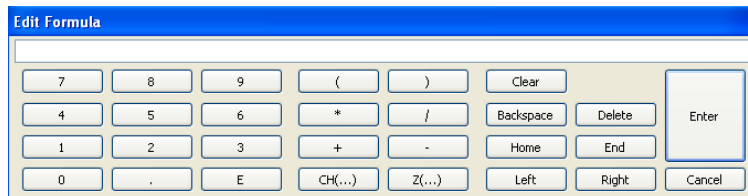

NOTE

In the following cases, an error icon **ERR** will appear at the front of the calculation expression. Measurement cannot start when the error icon is displayed so please enter the calculation expression again.

- After entering the calculation expression, the structure of the device changes and the channel in the calculation expression cannot be referred to.
- The calculation expression of a high speed channel is combined with the calculation expression of a low speed channel in dual sampling.

Key	Description
Clear	Erase the arithmetic expression totally.
Backspace	Erase the character preceding the cursor one by one.
Delete	Erase the character following the cursor one by one.
Home	Moves the cursor to the head of the arithmetic expression.
←	Moves the cursor left.
→	Moves the cursor right.
End	Moves the cursor to the end of the arithmetic expression.
CH (...)	Displays the dialog box. (See "Selecting measurement channel".) Select the measurement channel in the dialog box. Select device → unit → channel. The selected channel reflects on the arithmetic expression.
Z (...)	Displays the dialog box. (See "Selecting calculation channel".) Select the calculation channel in the dialog box. The selected calculation channel reflects on the calculation expression.
E	To enter constant number with exponential. (Example: 10000→1E4)

Selecting measurement channel

Example: To select 8423 Device 1, Unit 1 and Channel 1.

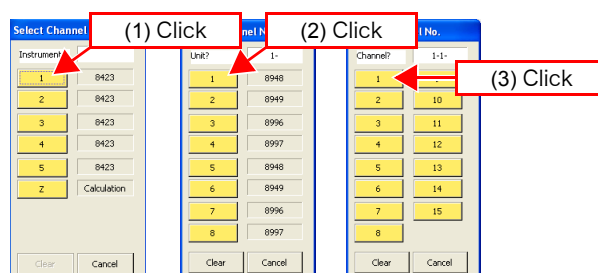

Selecting calculation channel

Example: To select Channel Z1.

* When a two-digit channel such as Z11 is entered, it reflects on the arithmetic expression without clicking **[OK]**.

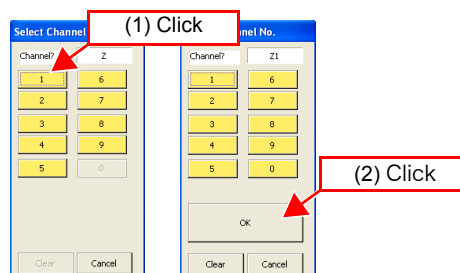

Sample arithmetic expression

Calculation	Arithmetic expression
"Measured value of Unit 3 Channel 3 in 8423 Device 1 "**3+6	3*CH(1,3,1)+6
"Measured value of Unit 1 Channel 9 in 8423 Device 2""Measured value of Unit 3 Channel 1 in Device 8423"	CH(2,1,9)*CH(1,3,1)
The result of arithmetic expression Z3**5	Z(3)*5

6. Enter unit and comment as required.

Up to 7 characters for unit and up to 40 characters for comment can be entered.

5.4.3 Setting the Display Method

This section describes configuring settings such as the display color, number of display digits, and scaling for each channel on the display settings page of the channel settings.

Scaling Function

In the case of the 8948 Voltage/Temp Unit and 8949 Universal Unit:

Use of the scaling function enables converting the output voltage obtained from, for instance, a sensor to the physical quantity of the measurement object in order to perform measurement. The gauge graduations, scale (vertical axis upper limit value and lower limit value) values, and A-B cursor measurement values can be displayed as scaled values and units. The following two types of scaling methods are available.

- **Setting by ratio**

Set the physical quantity per 1 V input signal (ratio eu/V), offset value, and unit name for conversion (eu: engineering unit), and convert the measurement values obtained as voltage values to values of the set unit.

Example

Ratio: Value of A/V

Offset Value: B

Unit name: A

Convert from slope (ratio) and offset value

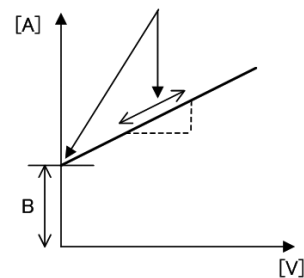

- **Setting by 2 points**

Set the voltage values at 2 points of the input signal, the conversion value of those 2 points, and the unit name for conversion, and convert the measurement values obtained as voltage values to values of the set unit.

Example

Unit values for conversion of voltage values at 2 points

V_H : High voltage point

A_H : Conversion value for the high voltage point

V_L : Low voltage point

A_L : Conversion value for the low voltage point

Unit name: A

Calculate ratio from 2 points and offset value and then convert

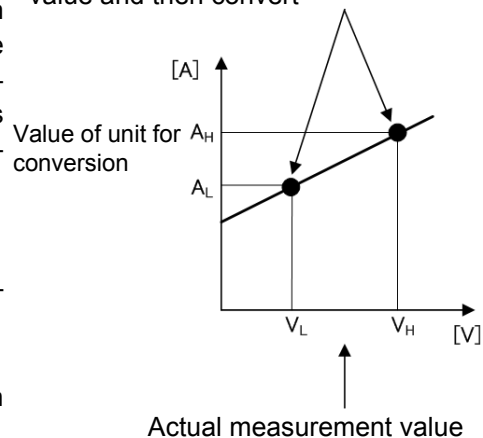

In the case of the 8996 Digital/Pulse Unit (totalization measurement):

Use of the scaling function enables converting the totalized number of pulses to the physical quantity (Wh, VA, etc.) of the measurement object in order to perform measurement. For pulse output devices, the physical quantity per pulse or the number of pulses per fundamental unit (e.g., 1 kWh, 1 liter, 1 m³) is determined. You can use either of the settings in the scaling settings. The following two types of scaling methods are available.

- **Setting method 1**
Enter the physical quantity per pulse.
- **Setting method 2**
Enter the number of pulses per fundamental unit.

In the case of the 8996 Digital/Pulse Unit (rotation rate measurement):

Use of the scaling function enables converting the number of pulses per second to the rotation rate per unit time in order to perform measurement.

- **Setting by ratio**
Set the unit time and offset value, and convert to the rotation rate per unit time.
- **Setting by 2 points**
Set the rotation rate at 2 points of the number of input pulses, the conversion value of those 2 points, and the unit name for conversion, and convert to the rotation rate per unit time.

1. **Select the channel you want to set on the display settings page of the channel settings.**

Narrowing down of display channels (p. 129)

Copy the channel setting information to another channel (p. 128)

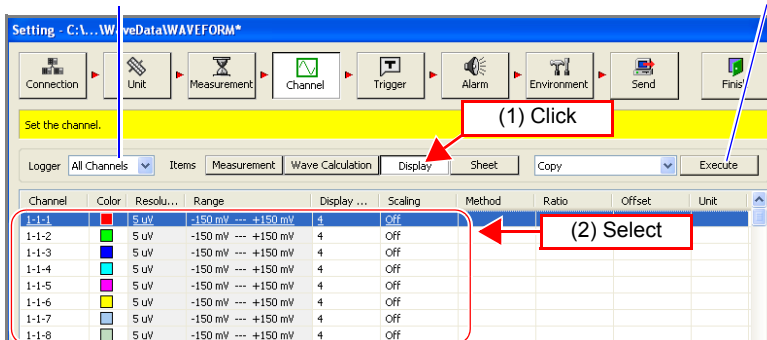

2. **Set the number of display digits and scaling.**

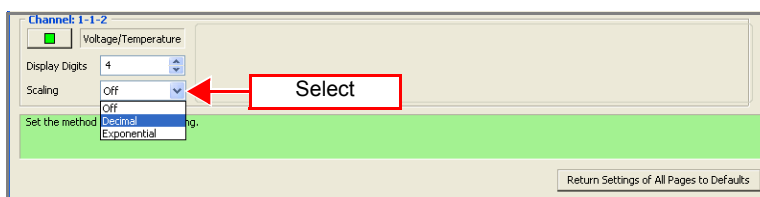

Selectable Items	Explanations
OFF	Scaling will not be converted.
Decimal	Scaling will be converted and the value displayed by decimal.
Exponential	Scaling will be converted and the value displayed by exponential.

5.4 Advanced Settings for Each Channel

3. Set the setting method.

In the case of the 8948 Voltage/Temp Unit or 8949 Universal Unit:

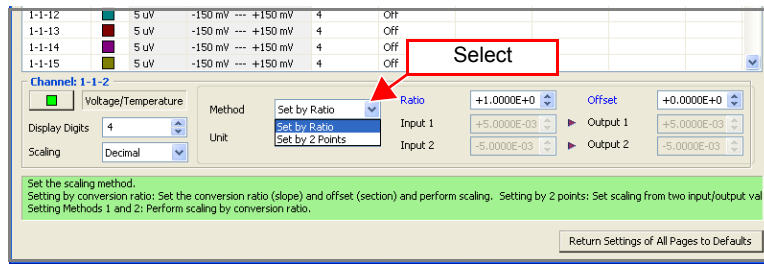

Selectable Items	Explanations
Set by Ratio	Set the ratio and offset.
Set by 2 Points	Set the values of any 2 points.

In the case of the 8996 Digital/Pulse Unit (totalization measurement):

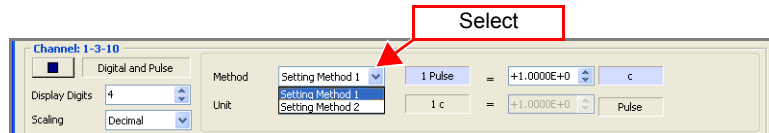

Selectable Items	Explanations
Setting Method 1	Set scaling by the physical quantity per pulse.
Setting Method 2	Set scaling by the number of pulses per fundamental unit.

In the case of the 8996 Digital/Pulse Unit (rotation rate measurement):

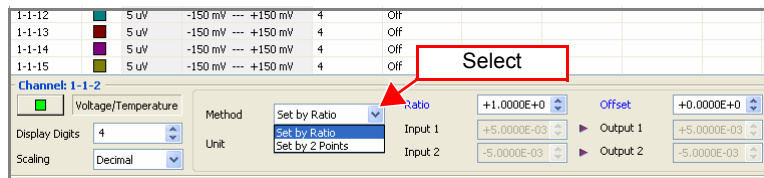

Selectable Items	Explanations
Set by Ratio	Set the ratio and offset.
Set by 2 Points	Set the values of any 2 points.

4. If the setting method is "Set by Ratio", set the unit, ratio, and offset.

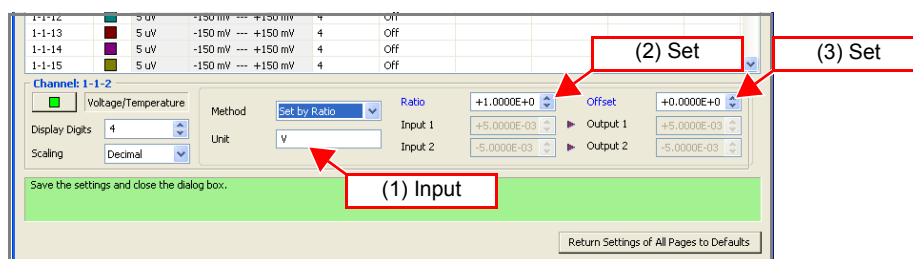

5. If the setting method is "Set by 2 Points", set the unit, inputs 1 and 2, and outputs 1 and 2.

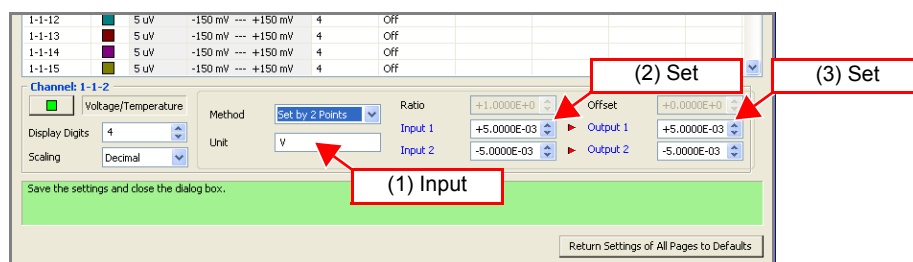

6. If the setting method is "Setting Method 1," set the physical quantity per pulse.

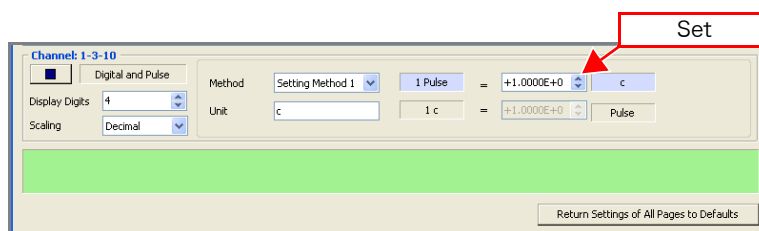

7. If the setting method is "Setting Method 2," set the number of pulses per fundamental unit.

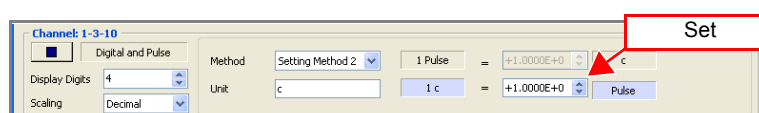

NOTE

- The values of "Set by Ratio" and "Set by 2 Points" are linked so that the settings become the same.
- The values of "Setting Method 1" and "Setting Method 2" are linked so that the settings become the same.
- Up to 7 byte characters can be entered for the unit. Double byte characters are displayed as "*" in the display area of the instrument.

5.4 Advanced Settings for Each Channel

Scaling Examples:

- **In the case of the 8948 Voltage/Temp Unit or 8949 Universal Unit:**
Use Hioki's 9322 DIFFERENTIAL PROBE to measure the effective value of the voltage of a commercial power supply

Set "Set by Ratio"

Set the ratio to 1000 (ratio of the 9322: 1/1000)

Set the unit to [Vrms]

Channel: 1-1-2

Method: Set by Ratio, Ratio: 1000, Offset: 0

Unit: Vrms

Input 1: +5.0000E-03, Input 2: -5.0000E-03

Output 1: +5.0000E+00, Output 2: -5.0000E+00

Display Digits: 4, Scaling: Decimal

- **In the case of the 8996 Digital/Pulse Unit (totalization measurement):**
Connect a 50,000 pulse/kWh supply meter for measurement
Set setting method 2
Set the unit to [kWh]
1 [kWh] = [50000] pulses

Channel: 1-3-8

Method: Setting Method 2

Unit: kWh

1 Pulse = +2.0000E-5 kWh

1 kWh = 50000 Pulse

Display Digits: 4, Scaling: Decimal

Connect a 10 liter/pulse flowmeter for measurement

Set setting method 1

Set the unit to [L]

1 pulse = [10] [L]

Channel: 1-3-9

Method: Setting Method 1

Unit: L

1 Pulse = 10 L

1 L = +1.0000E-1 Pulse

Display Digits: 4, Scaling: Decimal

- **In the case of the 8996 Digital/Pulse Unit (rotation rate measurement):**
Measure using rotation rate per minute r/min (rpm)
Set "Set by Ratio"
Set the ratio to 60 (Reference: If per hour, the ratio is 3600)
Set the unit to [r/min]

Channel: 1-10

Method: Set by Ratio, Ratio: 60, Offset: 0

Unit: r/min

Input 1: +5.0000E-03, Input 2: -5.0000E-03

Output 1: +3.0000E-01, Output 2: -3.0000E-01

Display Digits: 4, Scaling: Decimal

5.4.4 Assigning Channels to Sheets

There are 11 sheets in the waveform display area of the main screen. You can select the channels you want to display and assign them to sheets. The 11 sheets include an ALL sheet for displaying all of the channels.

1. Select the sheet you want to set on the sheet settings page of the channel settings. You can rename the sheet as you wish.
2. Select a channel to display on the sheet, and click the [Display] button to turn display ON.

Narrowing down of display channels (p. 129)

3. In the case of the 8948 Voltage/Temp Unit, 8949 Universal Unit, and 8996 Digital/Pulse Unit (input type: pulse), set the upper limit and lower limit of the screen display.

Channel: 1-1-1

Unit: Voltage/Temperature Upper: +1.5000E-01

Display: ON Lower: -1.5000E-01

Selectable Items	Setting Ranges
Upper	0.0000E+00 to 9.9999E+29
Lower	-0.0000E+00 to -9.9999E+29

NOTE

To directly input the screen display upper limit and lower limit values, press the Enter key on the keyboard each time after each value has been inputted to set it.

5.4 Advanced Settings for Each Channel

- In the case of the 8996 Digital/Pulse Unit (input type: logic), set the display position on the screen.

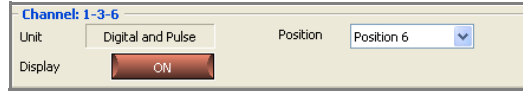

Selectable Items	Setting Ranges
Position	Position 1 to 25

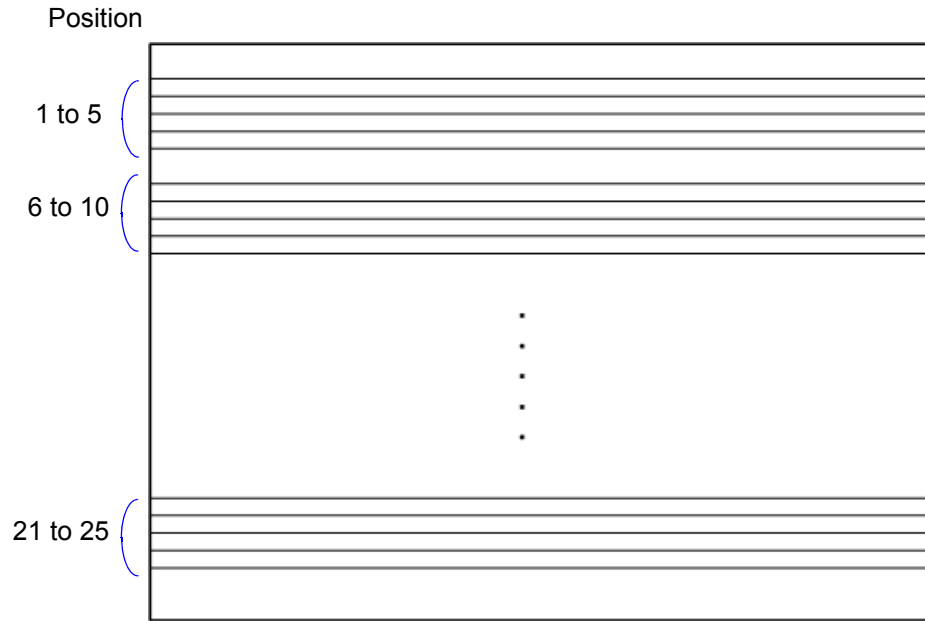

Waveform Display Area

5.5 Setting the Trigger Function

This section describes setting the trigger function. The trigger function can be set to start or end measurement when a set condition is satisfied. The following signals (trigger sources) are available for applying triggers. Triggers are ignored during recording operation.

Trigger Sources	Explanations
Analog trigger (p. 114)	A trigger is applied by an input signal of an analog channel. (Level trigger, window trigger)
Logic trigger (p. 117)	AND/OR is set for the input signal (1/0/x) of a logic channel in order to apply a trigger when the condition is satisfied.
External trigger (p. 113)	A trigger is applied by an input signal of the SMPL/TRIG terminal (external control input terminal).

NOTE

The trigger setting is invalid if synchronized measurement is not performed with at least two instruments.

5.5.1 Recording Operation during Simultaneous Use of Timer Measurement and Triggers

The following sections show the relation with repeat recording during the simultaneous use of timer measurement and triggers.

Repeat Recording Off

Normal recording operation

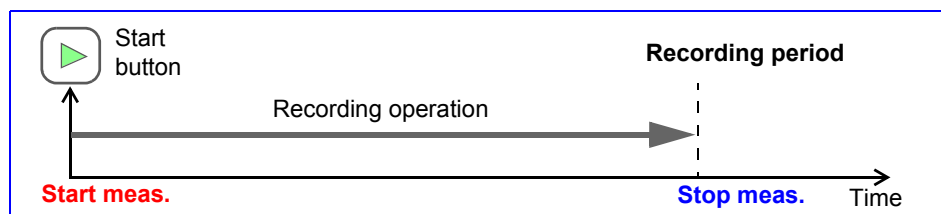

When measurement stopped within recording period

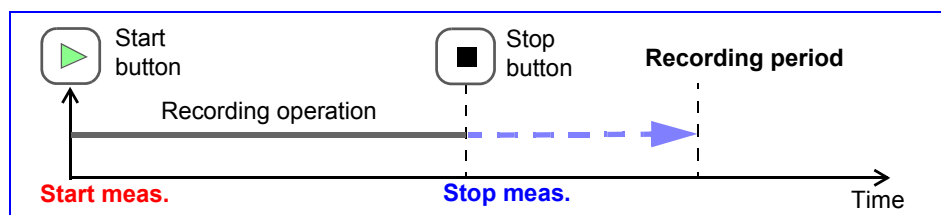

When measurement start time is set for timer measurement

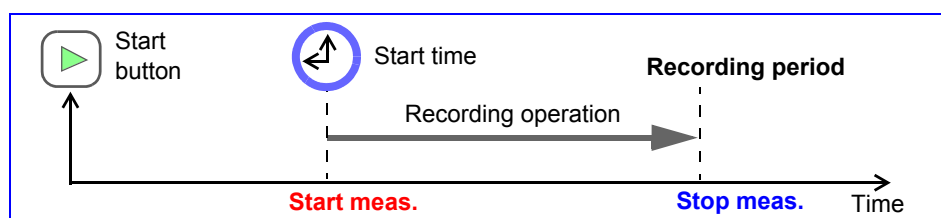

5.5 Setting the Trigger Function

When measurement stop time is set after recording period for timer measurement

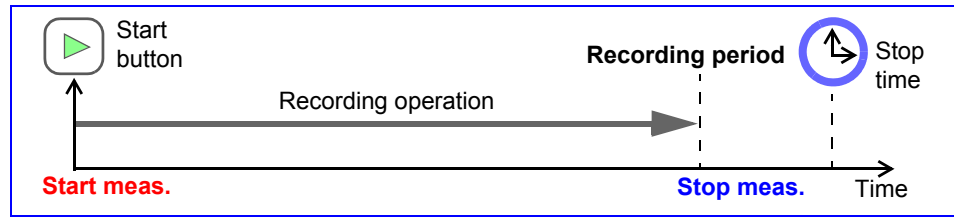

When measurement stop time is set within recording period for timer measurement

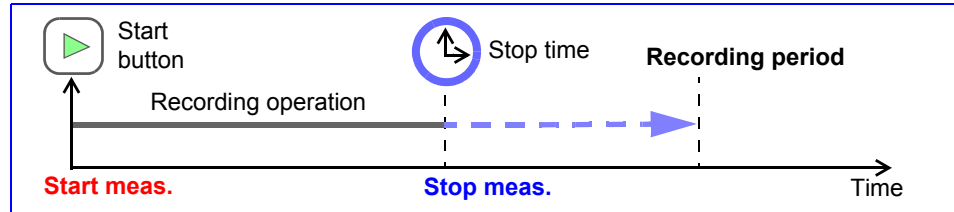

When measurement start time is set for timer measurement and stop time is set within recording period

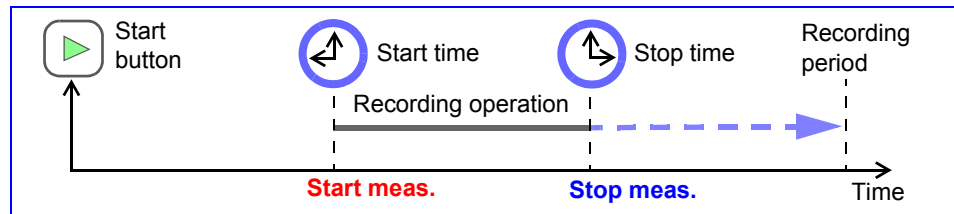

When start trigger is set

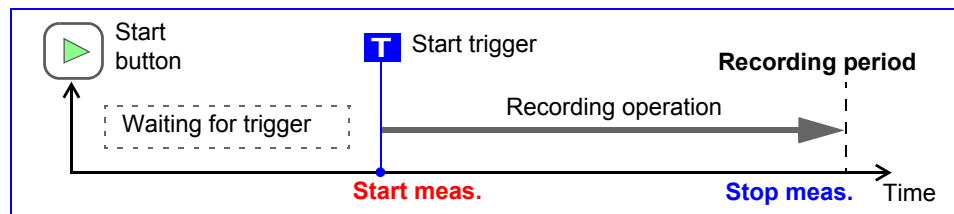

When stop trigger is set and stop trigger is applied before recording period

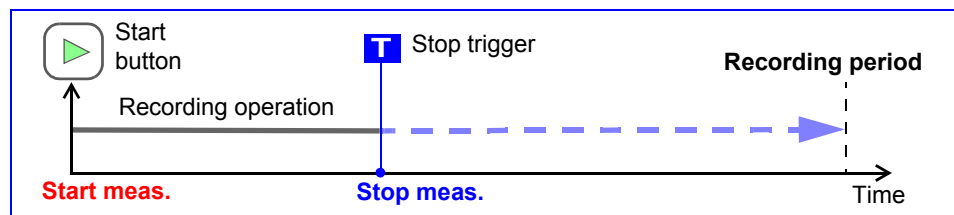

When start trigger is applied during timer measurement and stop trigger is applied before measurement stop time

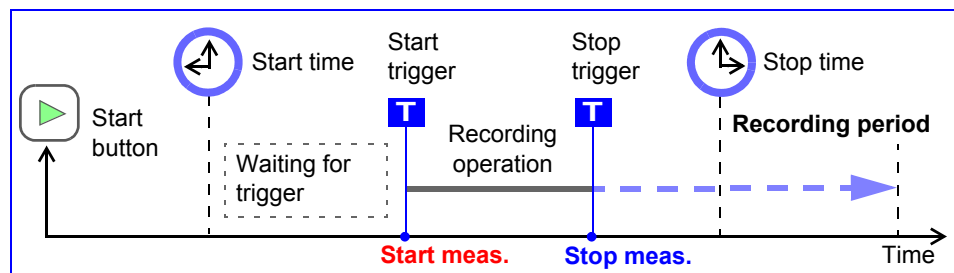

Repeat Recording On

Normal repeat recording operation

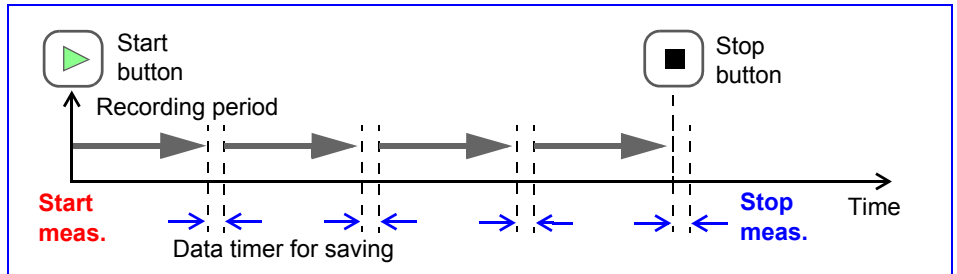

When measurement stopped within recording period

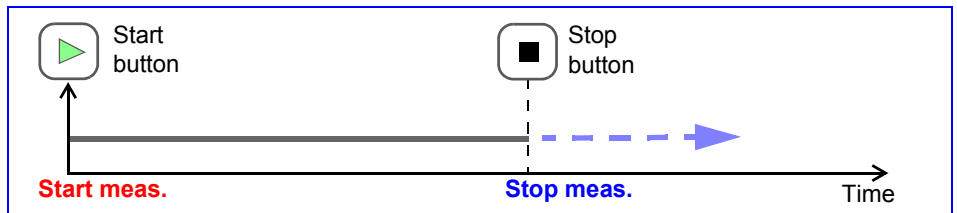

When measurement start time is set for timer measurement

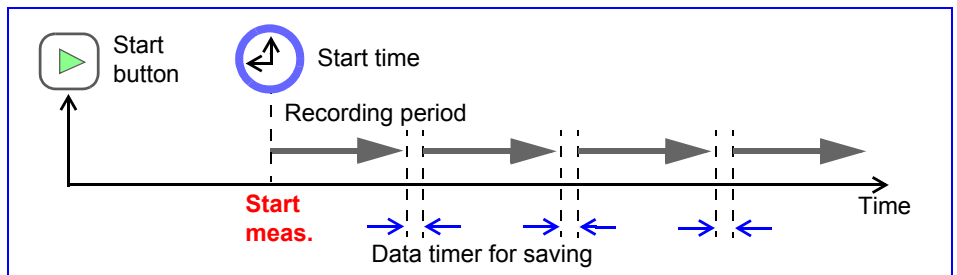

When measurement stop time is set after recording period for timer measurement

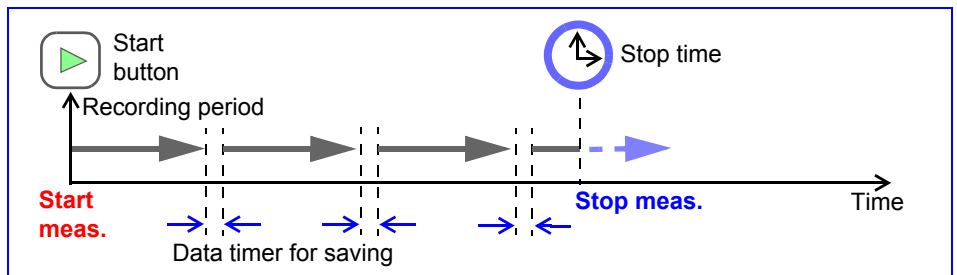

When measurement stop time is set within recording period for timer measurement

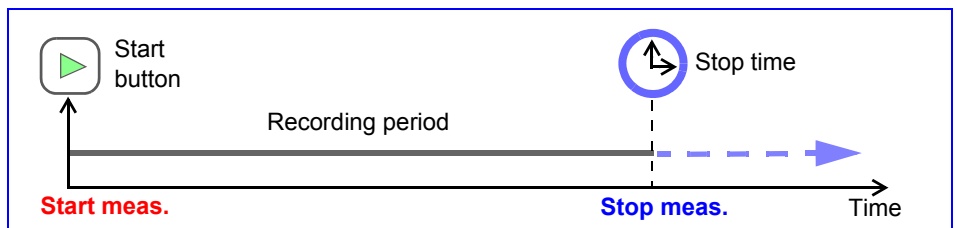

5.5 Setting the Trigger Function

When measurement start time is set for timer measurement and stop time is set after recording period

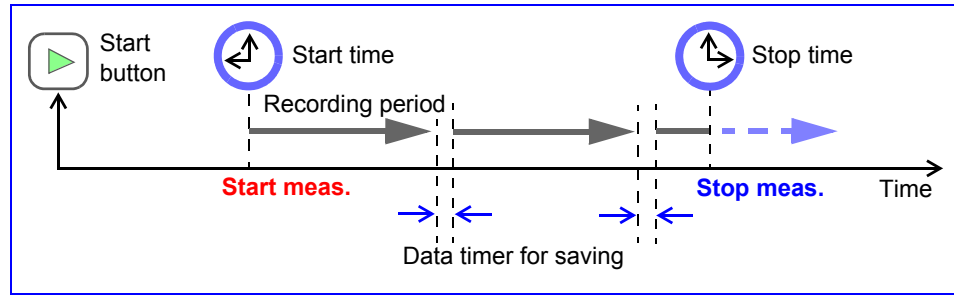

When start trigger is set

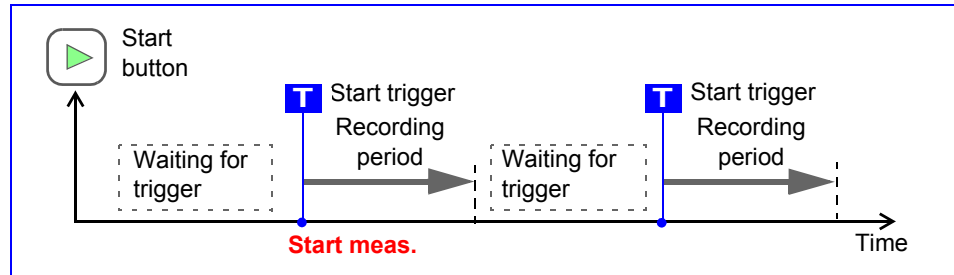

When stop trigger is set and stop trigger is applied before recording period

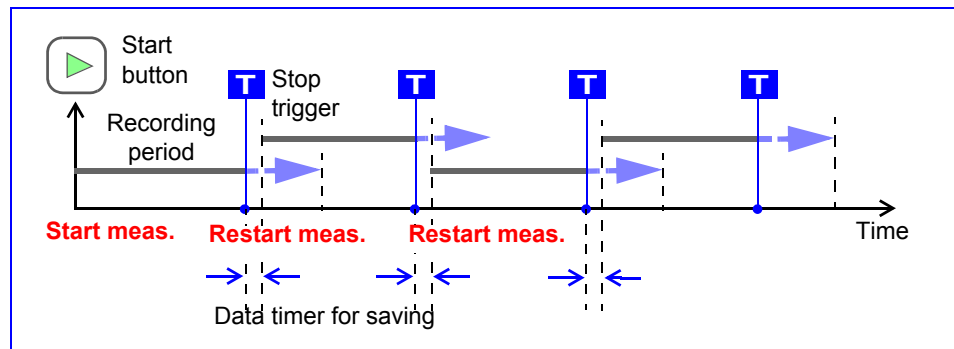

When start trigger is applied during timer measurement and stop trigger is applied before measurement stop time

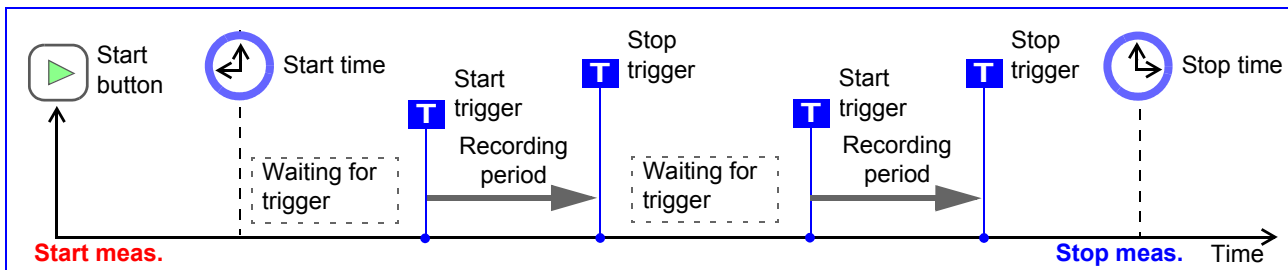

5.5.2 Pre-trigger

If the pre-trigger is set, waveforms are recorded not just after a trigger but both before and after a trigger.

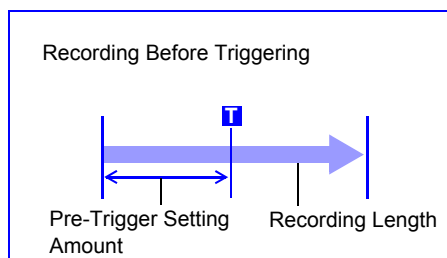

1. Open the trigger settings page.
2. Set the trigger function to ON.

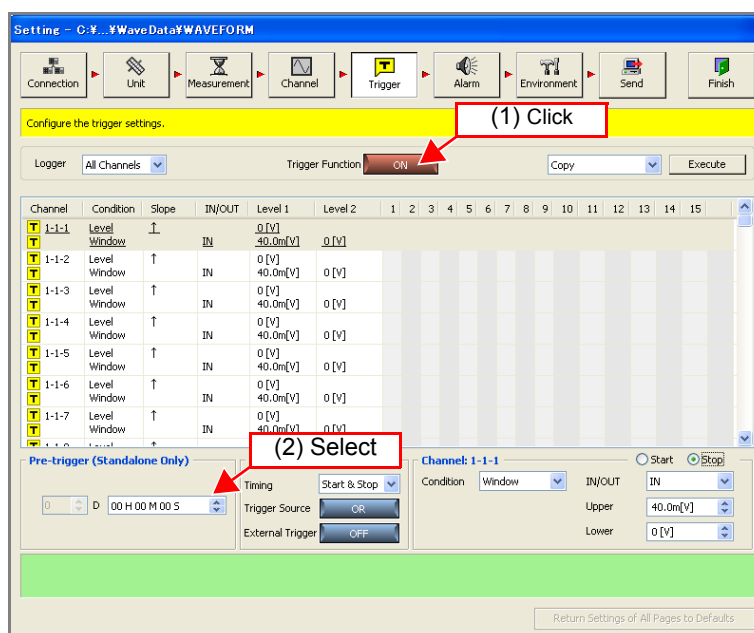

3. Set the pre-trigger. Enter the time to apply the trigger.

You can use the [← →] left and right arrow keys on the keyboard to move to an input item, and the [↑ ↓] up and down arrow keys to increase and decrease the value.

NOTE

- The pre-trigger function is only enabled when you perform standalone measurement. The setting is ignored when you use Logger Utility to perform computer based measurement.
- The pre-trigger cannot be used when the function is set to external sampling.
- The settable range for the pre-trigger varies depending on the recording interval that is set.
Possible setting range: 0 to 100,000 x Recording interval
- If a pre-trigger is set, the status becomes **[Waiting for Pre-trigger]** and a trigger cannot be accepted during the period of time from the start of measurement to the time set for the pre-trigger. **[Waiting for Trigger]** is displayed until the instrument enters the trigger accept status and a trigger is applied.
- To record the waveform generated after trigger, set the recording duration longer than pretrigger.

See "Relationship between pretrigger and recording duration" (p. 110)

Relationship between pretrigger and recording duration

<Recording duration shorter than pre-trigger>

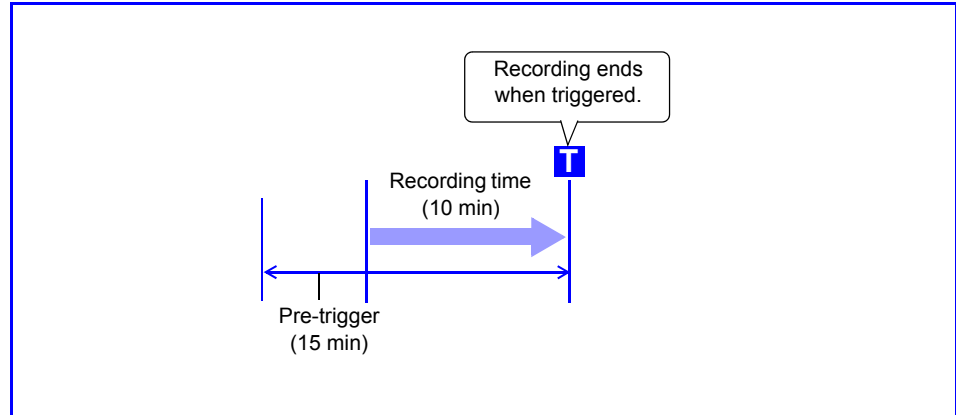

<Recording duration longer than pre-trigger>

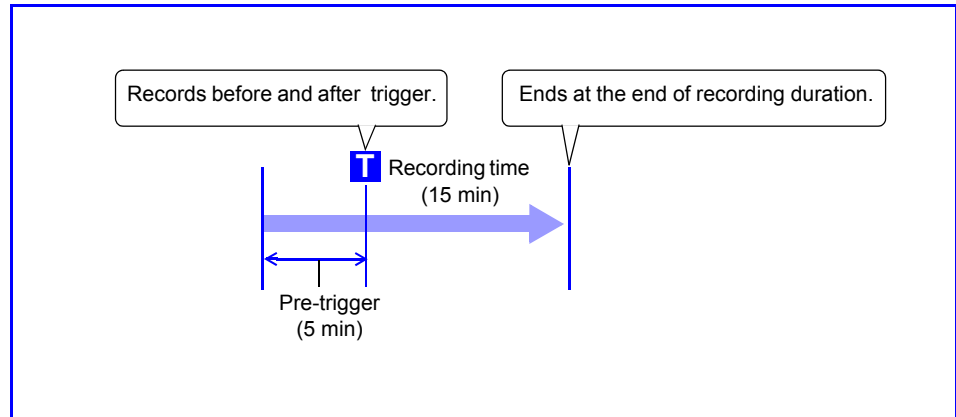

5.5.3 Trigger Timing

This section describes setting the time relation between the satisfying of a trigger condition and the waveforms recorded.

You can set a trigger condition for each of start and stop.

Set the trigger timing condition for each logger.

1. **Set the trigger function on the trigger settings page to ON.**
Each click of the button toggles the trigger function ON and OFF.
2. **Select the trigger timing.**

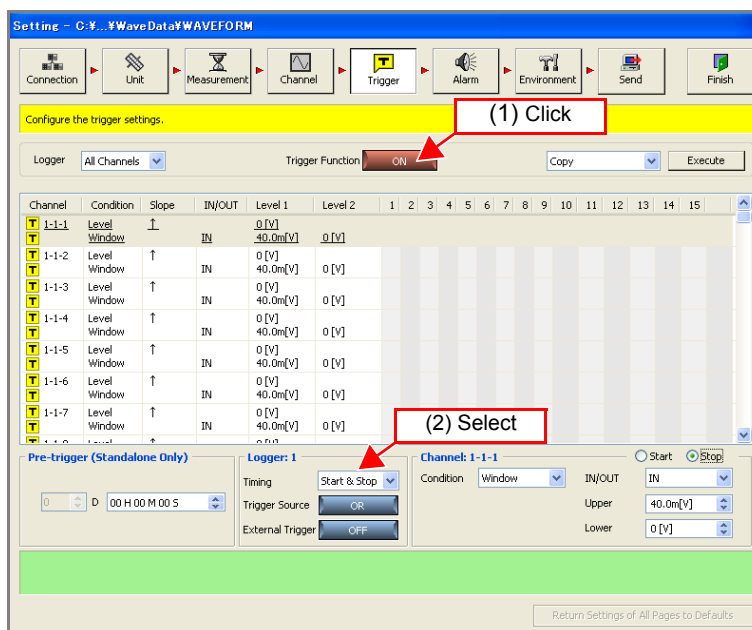

Selectable Items	Explanations
Start	Waveforms are recorded from the point in time a trigger is applied.
Stop	Recording is performed from the point in time  button is clicked to the point in time a trigger is applied.
Start & Stop	Waveforms are recorded from the point in time a trigger is applied to the point in time the next trigger is applied.

5.5.4 Trigger Sources

An analog trigger, logic trigger, and external trigger can be linked with AND/OR logical operators. This sets the time relation between the satisfying of a condition and the waveforms recorded. You can set AND/OR for each of start and stop. Set the trigger source condition for each logger.

1. **Set the trigger function on the trigger settings page to ON.**
Each click of the button toggles the trigger function ON and OFF.
2. **Select the trigger source.**
Each click of the button toggles the trigger source AND and OR.

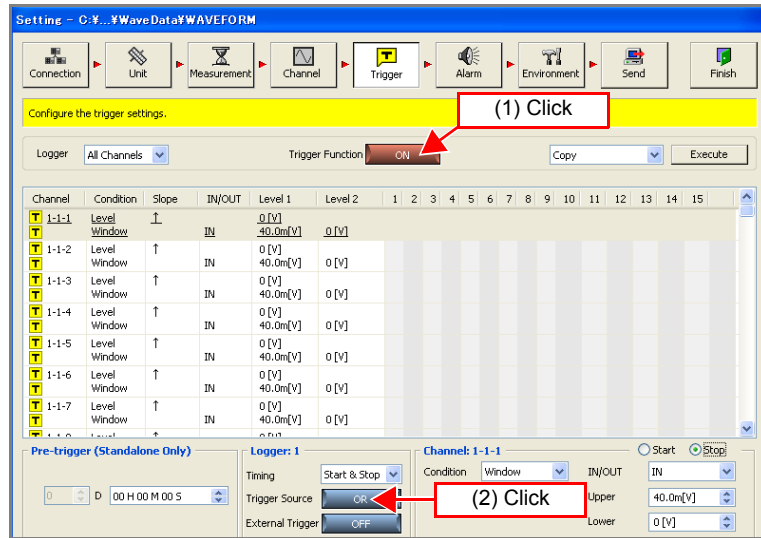

Selectable Items	Explanations
OR	A trigger is applied when any one of the trigger conditions is satisfied.
AND	A trigger is applied when all of the trigger conditions are satisfied.

If channel 1-1-1 and channel 1-1-2 are set to a level trigger of 0.00 V (↑), a trigger is applied for each of AND and OR as shown below. (p. 115)

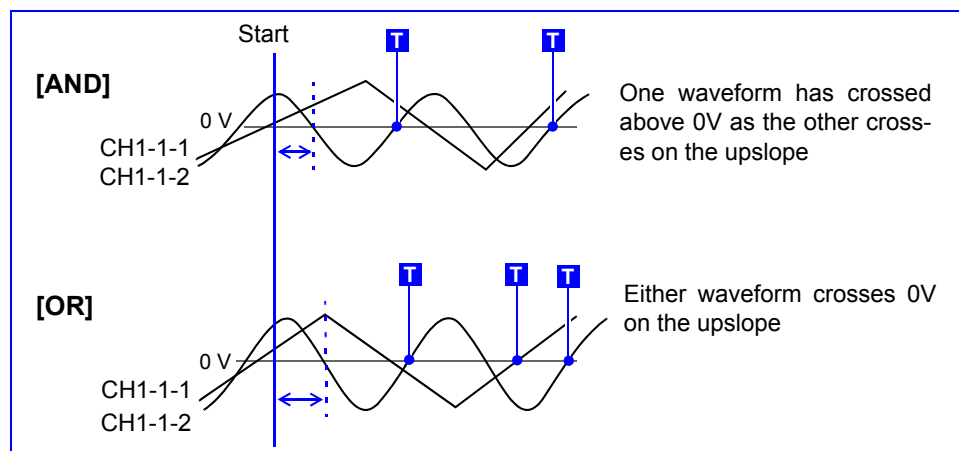

NOTE

A trigger is not applied if the trigger condition is already satisfied when measurement starts. If the condition of one of the trigger sources is no longer satisfied and then the condition is satisfied again, a trigger is applied.

5.5.5 External Triggers

A trigger can be applied from an input signal of the SMPL/TRIG terminal (external control input terminal). Set an external trigger for each logger. For details on the signal input conditions of the SMPL/TRIG terminal, see "5.7.1 Setting External Control Input Terminals" (p. 121).

1. **Set the trigger function on the trigger settings page to ON.**
Each click of the button toggles the trigger function ON and OFF.
2. **Select the external trigger.**
Each click of the button toggles the external trigger ON and OFF.

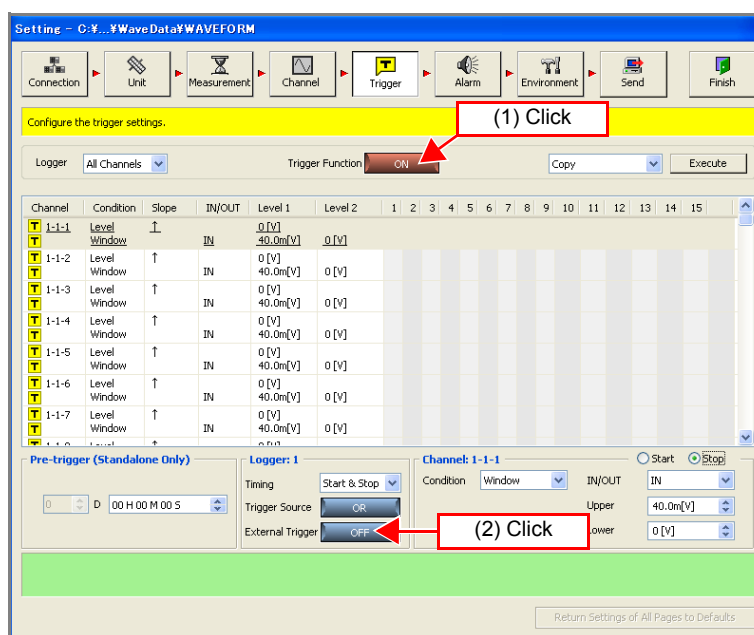

Selectable Items	Explanations
OFF	The external trigger is disabled.
ON	The external trigger is enabled.

NOTE

If the measurement function is set to "External Sampling," the external trigger cannot be used.

5.5.6 Analog Triggers

This section describes setting a trigger that uses an analog input signal. This can be set for each channel.

1. **Set the trigger function on the trigger settings page to ON.**
Each click of the button toggles the trigger function ON and OFF.
2. **Select the channel for which to set the trigger function on the trigger settings page.**
If you want to reduce the number of display channels, use the narrow down feature to select the channels to display.
3. **Set the trigger condition.**
The setting values differ depending on setting of the trigger condition. For details, see the following.

The screenshot shows the 'Setting - C:\... \WaveData\WAVEFORM' window. The 'Trigger' tab is active. A yellow banner at the top says 'Configure the trigger settings.' Below it, the 'Trigger Function' is set to 'ON'. A table lists channels and their conditions. At the bottom, the 'Pre-trigger (Standalone Only)' section is expanded for 'Channel: 1-1-1', showing 'Timing' (00 H 00 M 00 S), 'Trigger Source' (Start & Stop), and 'Condition' (Window). The 'Upper' and 'Lower' limit values are set to 40.0m[V] and 0[V] respectively.

T : Trigger ON

When the trigger timing is "Start & Stop," set each of the start trigger condition and stop trigger condition.

Selectable Items	Explanations
Level	<p>A trigger can be applied when the input signal crosses the set level value (threshold value) on the set slope (↑ or ↓).</p> <p>Trigger level</p> <p>Input signal</p> <p>Trigger slope: [↑] [↓]</p>
Window	<p>Set the upper limit value and lower limit value to apply a trigger when the input signal enters (IN) or exits (OUT) the corresponding range.</p> <p>Upper limit value</p> <p>Lower limit value</p> <p>IN</p> <p>OUT</p>

When Level Trigger is Selected

Set the level value and slope.

Level value:

Set the level value for applying a trigger. The scaling setting is reflected.

Slope:

Select the slope for when the input signal crosses the level value for applying a trigger.

Selectable Items	Explanations
↑	A trigger is applied when the level value is crossed on the rising slope.
↓	A trigger is applied when the level value is crossed on the falling slope.

NOTE

A trigger is not applied if the trigger condition is satisfied at start time.

Trigger Resolution

Measurement Object	Range	Trigger Resolution	Maximum Resolution
Voltage	100 mV f.s.	100 μ V	5 μ V
	1 V f.s.	1 mV	50 μ V
	10 V f.s.	10 mV	500 μ V
	20 V f.s.	20 mV	1 mV
	100 V f.s.	100 mV	5 mV
	1-5 V f.s.	10 mV	500 μ V
Temperature	100°C f.s.	0.1°C	0.01°C
	500°C f.s.	0.5°C	0.05°C
	2000°C f.s.	2°C	0.1°C
Humidity	100%RH	0.1%RH	0.1%RH
Pulse totalization	1000 Mpulses f.s.	1 pulse	1 pulse
Pulse rotation rate	5000 [r/s]	1/ (Pulse rotation rate) [r/s]	1/ (Pulse rotation rate) [r/s]

When Window Trigger is Selected

Set IN/OUT and the upper limit value and lower limit value.

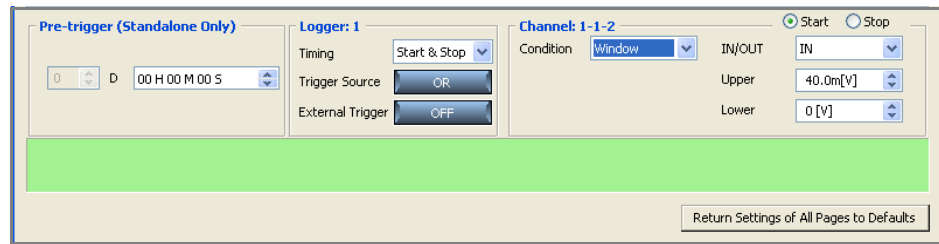

IN/OUT:

Selectable Items	Explanations
IN	A trigger is applied when a value enters within the range of the window (upper and lower limit values).
OUT	A trigger is applied when a value exits from the range of the window (upper and lower limit values).

Upper/Lower:

Set the level value for applying a trigger. The scaling setting is reflected. It is not possible to set an upper limit value that is smaller than the lower limit, and a lower limit value that is larger than the upper limit value.

NOTE

A trigger is not applied if the trigger condition is satisfied at start time.

Example:

Window out trigger (upper limit value: 1 V, lower limit value: -1 V)

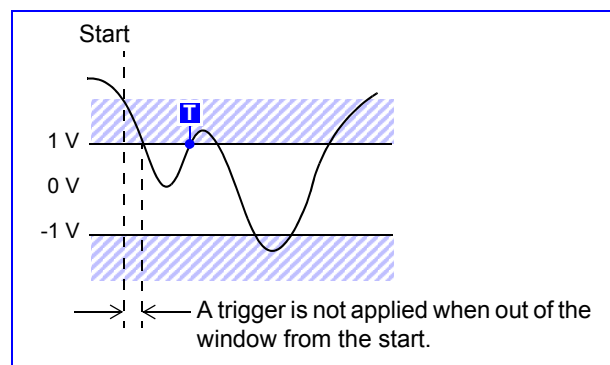

5.5.7 Logic Triggers

This section describes setting a trigger that uses a logic input signal. A logic trigger can be set when the input type of the 8996 Digital/Pulse Unit is set to **[Logic]**. (p. 95) Set the trigger pattern (1/0/x) and the AND/OR of the trigger pattern in order to apply a trigger when a condition is satisfied. This can be set for each channel.

NOTE

A logic trigger is applied immediately if a trigger condition is satisfied at start time.

1. Select the unit for which to set the trigger settings on the trigger settings page. Select a pattern for the whole of the unit for which logic is selected.

T : Trigger On

When the trigger timing is "Start & Stop," set each of the start trigger condition and stop trigger condition.

If you want to reduce the number of display channels, use the narrow down feature to select the channels to display.

2. Select the trigger conditions.

Selectable Items	Explanations
OR	A trigger is applied when any one of the trigger conditions set with the pattern is satisfied.
AND	A trigger is applied when all of the trigger conditions set with the pattern are satisfied.

3. Set the trigger pattern.

Selectable Items	Explanations
1	HIGH level signal
0	LOW level signal
x	Ignore signal

Clicking the **[All x]**, **[All 0]**, or **[All 1]** button allows you to convert all selected logic to the same value simultaneously.

5.6 Setting the Alarm Function

Connect the 8997 Alarm Unit when you want to use the alarm function. This alarm function is for outputting an alarm signal (open collector) from the channel of the 8997 Alarm Unit to an external device when the alarm condition set for the alarm function and the measurement value of a certain channel match. The output channel allows for an alarm condition to be set for any input channel.

1. Configure the common settings for the alarm on the alarm settings page.

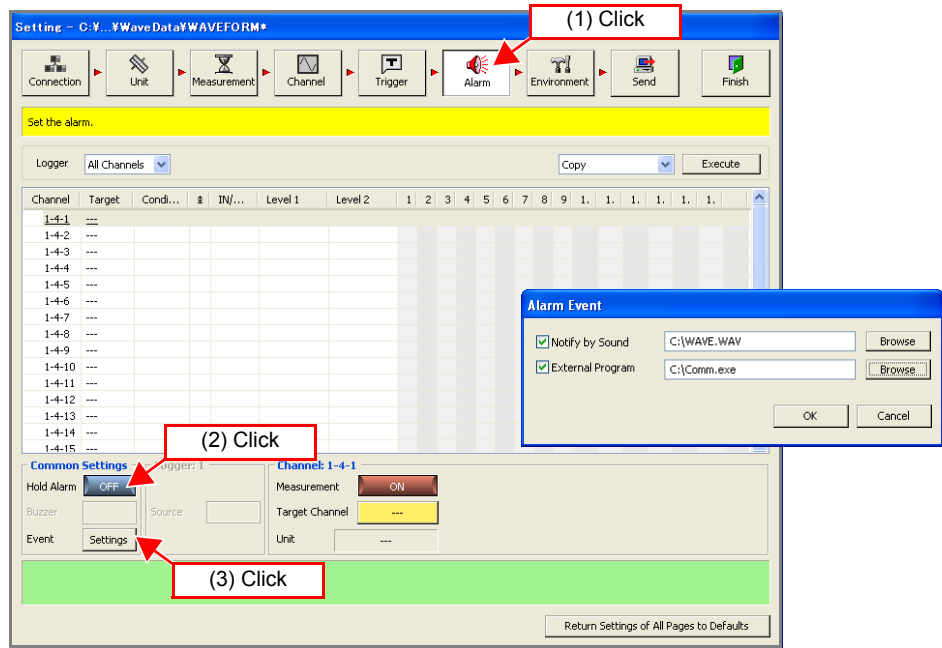

Alarm Hold: This sets whether to hold output when the alarm condition of a certain alarm channel is satisfied, and the alarm is output.

Selectable Items	Explanations
OFF	Stop alarm output when the alarm condition is no longer satisfied.
ON	Hold alarm output until measurement ends.

Event: Set a specific action to execute when an alarm is output.

Selectable Items	Explanations
Notify by Sound	Play any audio file (WAV format) when an alarm is output. Specify the location of the file.
External Program	Execute any external program when an alarm is output. Specify the location of the file.

2. Use the narrow down feature to select the instruments to set.

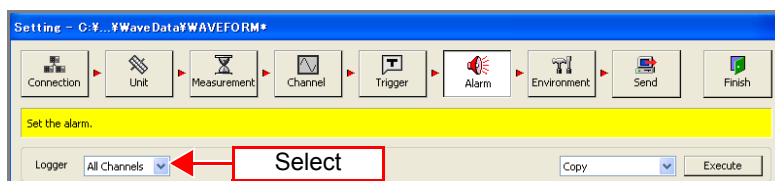

3. Set the alarm setting for each channel.

Example: Configure the alarm settings so that the voltage range of channel 13 (channel 1-1-13) of the 8948 Voltage/Temp Unit is the alarm target channel

(1) Click

(2) Click

(3) Click

(4) Click

(5) Set

When not using the alarm function even after setting the conditions, click to [OFF].

Alarm ON (displayed when the alarm function is set correctly)

Set the input channel for setting the alarm condition.

Condition:

Selectable Items	Explanations
Level	Output an alarm when the input signal satisfies the set level.
Window	Output an alarm when the input signal enters or exits the set range.

Level: (Setting is only possible when level is selected under certain conditions)
Set the level (threshold value). Setting for scaling will be reflected.

High/Low: (Setting is only possible when level is selected under certain conditions)

Selectable Items	Explanations
↑	Output an alarm when the value is larger than the set level value.
↓	Output an alarm when the value is less than the set level value.

IN/OUT: (Setting is only possible when window is selected under certain conditions)

Selectable Items	Explanations
IN	Alarm will be output whenever a value is within the range of the window (Upper/Lower limit values)
OUT	Alarm will be output whenever a value is outside the range of the window (Upper/Lower limit values)

5.6 Setting the Alarm Function

Upper/Lower: (Setting is only possible when window is selected under certain conditions)

Set the upper and lower limit values of the window. Setting for scaling will be reflected. The upper limit value cannot be set lower than the lower limit value and the lower limit value cannot be set higher than the upper limit value.

NOTE

- Only a channel within the same logger can be set as the alarm target channel. (Waveform calculation channel cannot be set up for alarm.)
 - If the alarm target channel is not valid, the target channel button is displayed in yellow.
 - When you use the alarm function, a minimum of at least one unit other than the 8997 Alarm Unit is required.
 - The alarm is output immediately if the condition is met at the start of measurement.
 - If a channel of the 8948 Voltage/Temp Unit or 8949 Universal Unit assigned to the low-speed side with dual sampling is set as the alarm target channel, alarm output may be delayed by a few samples from when the alarm condition is satisfied.
-

5.7 Setting Environment Conditions

This section describes configuring settings such as external control for the instrument and file saving for the CF card.

5.7.1 Setting External Control Input Terminals

This section describes setting the functions of the external control input terminals on the front of the instrument. Refer to "Chapter 3 Setting Up the Instrument" (p. 31) and connect the cables to the terminals beforehand.

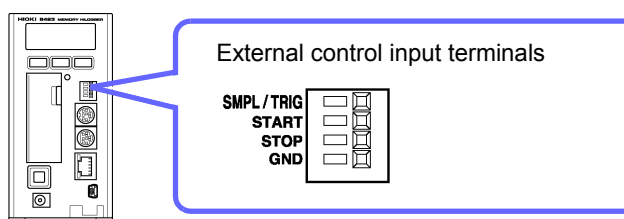

1. Click the icon of the logger you want to set on the environment settings page so that the background of the icon turns red.

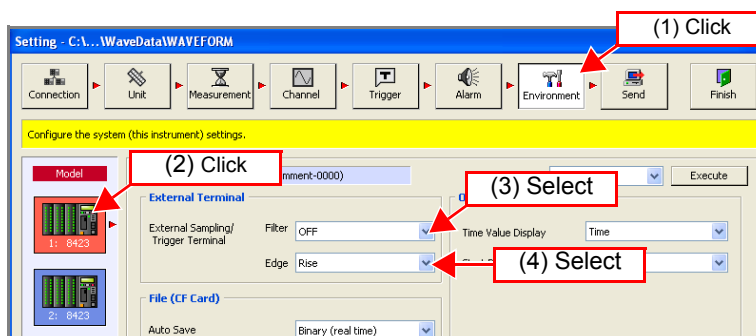

2. Set ON or OFF for the filter of the signal of each of the SMPL/TRIG, START, and STOP inputs of the external control input terminals.

By setting the filter to ON, you can reduce erroneous operation of the logger caused by chattering when performing control using, for example, a mechanical contact output.

3. Set the detection edge.

Set whether the sampling operation or trigger operation is performed with the rising or falling edge.

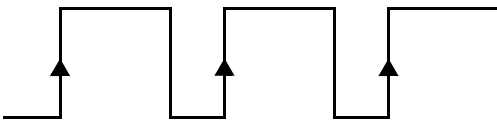
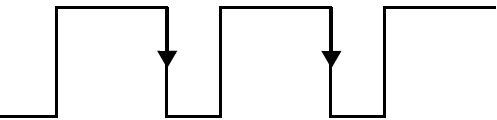
Selectable Items	Explanations
Rise	Perform sampling or trigger with the rise of the pulse. HIGH: 2.5 to 5.0 V LOW: 0 to 1.0 V 
Fall	Perform sampling or trigger with the fall of the pulse. HIGH: 2.5 to 5.0 V LOW: 0 to 1.0 V 

Functions of External Control Input Terminals

Terminal	Explanations	Accept Condition
SMPL/TRIG	This terminal is for controlling the external sampling operation or external trigger operation. If the measurement function is set to "External Sampling," the external trigger function cannot be used.	Edge
START	This terminal is for controlling the start operation from an external device. Shorting this terminal and the GND terminal performs the same operation as pressing START/MARK of the instrument.	Level
STOP	This terminal is for controlling the stop operation from an external device. Shorting this terminal and the GND terminal performs the same operation as pressing STOP of the instrument.	Level
GND	This is the GND terminal. It is common to the internal GND of the instrument.	-

Signal Input Condition of SMPL/TRIG Terminal

Filter OFF

Sampling is performed or a trigger is applied at a rise of a pulse or fall of a pulse of 1 ms or more at the HIGH level and 2 μs or more at the LOW level.

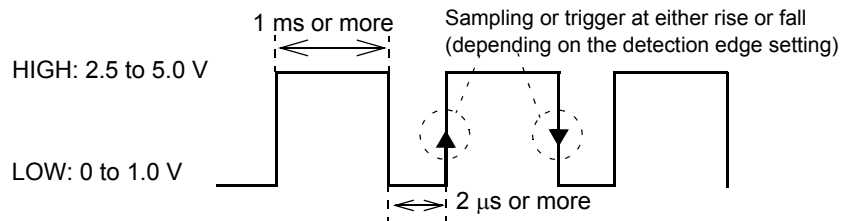

Filter ON

Sampling is performed or a trigger is applied at a rise of a pulse or fall of a pulse of 2.5 ms or more at the HIGH level and 2.5 ms or more at the LOW level. It is possible to reduce erroneous operation caused by chattering.

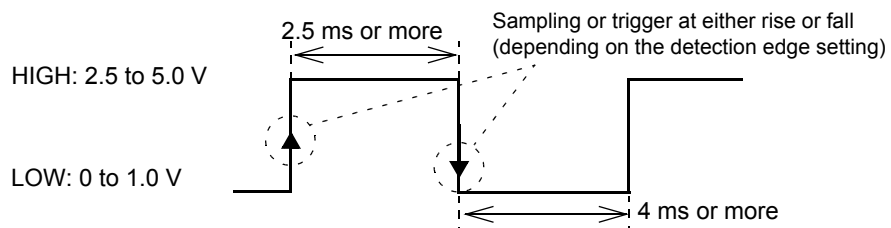

NOTE

- Each type of control will not be accepted if the input signal does not satisfy the condition above.
- A signal with an interval shorter than the maximum response speed for external sampling is ignored. (p. 81)

Signal Input Condition of START/STOP Terminal

Input a pulse of 50 ms or more at the LOW level.

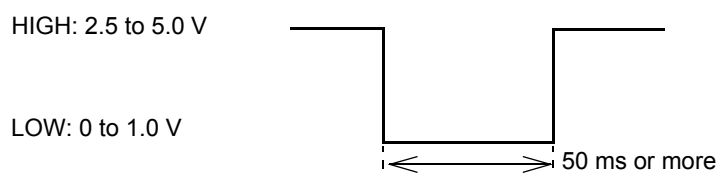

5.7.2 CF Card Save Settings

This section describes setting the method for saving data to a CF (compact flash) card inserted in the logger.

1. Click the icon of the logger you want to change the settings of on the environment settings page.
The background color of the selected icon turns red.
2. Configure the file (CF card) settings.

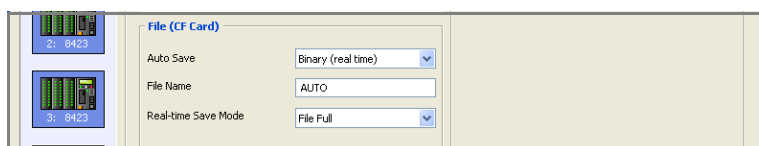

Select the auto save method.

Use the mouse to select the desired setting from the list.

Selectable Items	Explanations
OFF	Do not save measurement data to the CF card inserted in the logger.
Binary (real time)	Save measurement data in binary format to the CF card inserted in the logger, while measuring.

Enter the file name.

Use the keyboard to enter the file name to use for saving to the CF card. Enter up to 8 single-byte characters. If a file of the same name exists, a sequence number is added to the file name.

Select the real-time save mode.

Use the mouse to select the desired setting from the list.

Selectable Items	Explanations
File Full	Ends saving when there is no longer much available space on the CF card. However, measurement continues.
Delete and Save	When the amount of available space of the CF card reaches a certain level during measurement, the oldest file in the directory currently being recorded to is deleted and the new data is saved. If a file was unable to be deleted, the same operation as for [File Full] is performed.

NOTE

Go to the **[Auto Save Mode]** in the Measurement Setting page to carry out split saving (p. 83).

Delete and Save Conditions

- The files in the directory in which measurement files are created are subject to deletion.
 - Files with the ".MEM" extension are recognized as waveform files. Therefore, even a file of a completely different type is likely to be deleted if it has the ".MEM" extension, because it is recognized as waveform file.
 - Files are determined to be new or old by their time stamp (date and time of creation).
 - A file is not deleted if there is no more than one waveform file for which recording has finished in the directory. If an attempt is made to delete a waveform file that is too large for the capacity of the CF card, the file may not be able to be deleted. As a guideline, ensure the size of one file becomes less than a 1/4 that of the available space.
 - A search can be performed for up to 5000 files in a directory. If there are more files than that, the oldest file may not be able to be deleted.
 - If you are using split save, the operation is the same as when auto save is performed multiple times without splitting files. Therefore, even a file that was created by splitting after measuring once is deleted when regarded as old in terms of time.
-

5.7.3 Time Value Display

This section describes setting the display method for the time values of measurement data handled by the instrument. Set the display method for the time values shown when using the HTTP function (p. 209) to obtain internal memory data in text format.

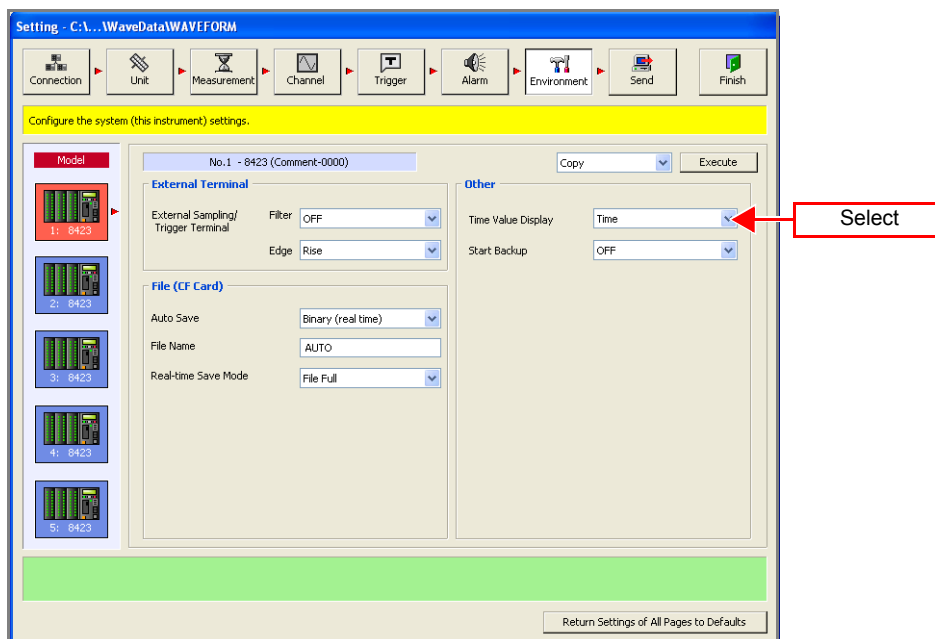

Selectable Items	Explanations
Time	Display the time since the start of measurement in hours, minutes, and seconds. If a trigger is set, the time since the trigger.
Date	Display the date and time the data was obtained.
Point	Display the number of data items since the start of measurement. If a trigger is set, the number of data items since the last trigger point.

5.7.4 Start Backup

This section describes setting the action to perform after the power supply is restored when there was a power cut (power outage) during recording. This setting is only enabled during standalone measurement.

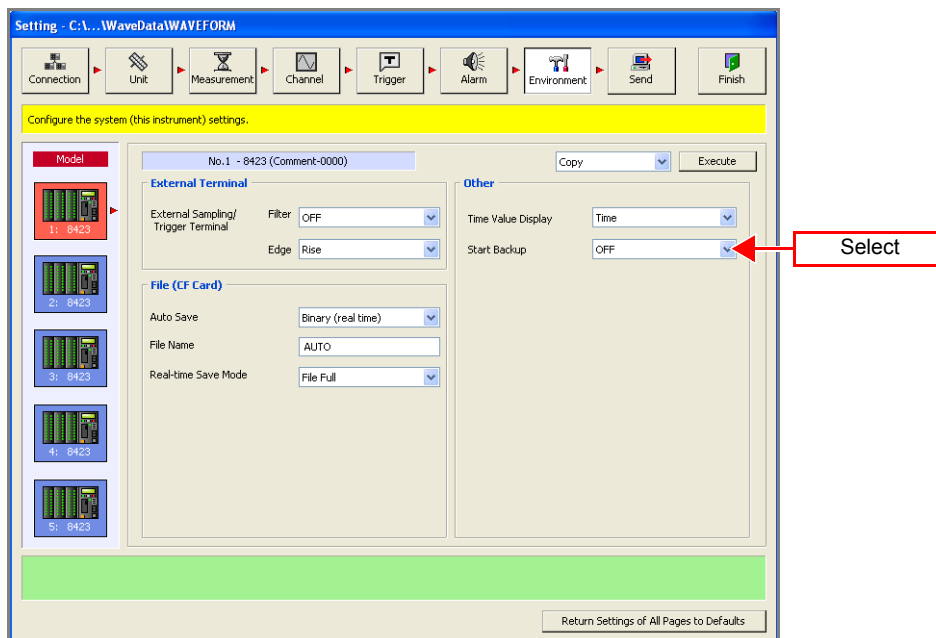

Selectable Items	Explanations
OFF	Stop measurement when there is a power cut.
ON	When the power supply is restored, the instrument enters the restart state and starts the recording operation. (Previous measurement data is discarded from the memory of the instrument.) If a trigger is being used, the instrument enters the trigger wait state.

NOTE

Even when the start backup function is ON, if the logger was being controlled by Logger Utility when the power outage occurred, the instrument will resume measurement but Logger Utility will not be able to resume measurement.

5.8 Send Settings

When you want to use just the logger for measurement without using a computer (standalone), send the settings to the logger beforehand.

1. Configure the settings in "5.1 Registering Loggers in Logger Utility" to "5.7 Setting Environment Conditions".
2. Click the [Send] button.

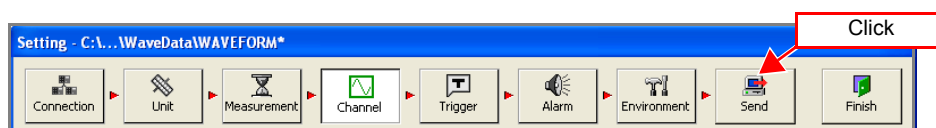

NOTE

- It is not possible to send the settings for a logger that is already measuring.
- There is no need to send the settings if you are using Logger Utility for control, because the settings are sent automatically at the start of measurement.

5.9 Process All

You can copy the setting information for any channel and paste it to other channels. This function is available on the following pages.

Setting Pages	Copy	Copy to Other Sheets	Reset Waveform Position
Measurement settings page of the channel settings	Yes	No	No
Waveform calculation setting page of the channel settings	Yes	No	No
Channel settings page of the channel settings	Yes	No	No
Sheet settings page of the channel settings	Yes	Yes	Yes
Trigger settings page	Yes	No	No
Alarm settings page	Yes	No	No
Environment settings page	Yes	No	No

1. If you want to copy the settings information to other channels, select [Copy], and click the [Execute] button after selecting the copy source channel.

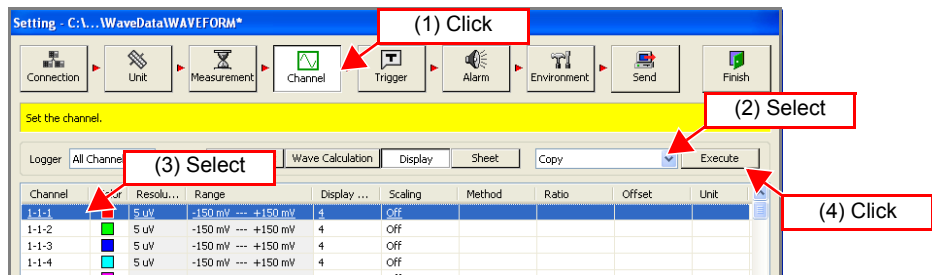

2. Select the parameters to copy and copy destinations, and then click [Copy].

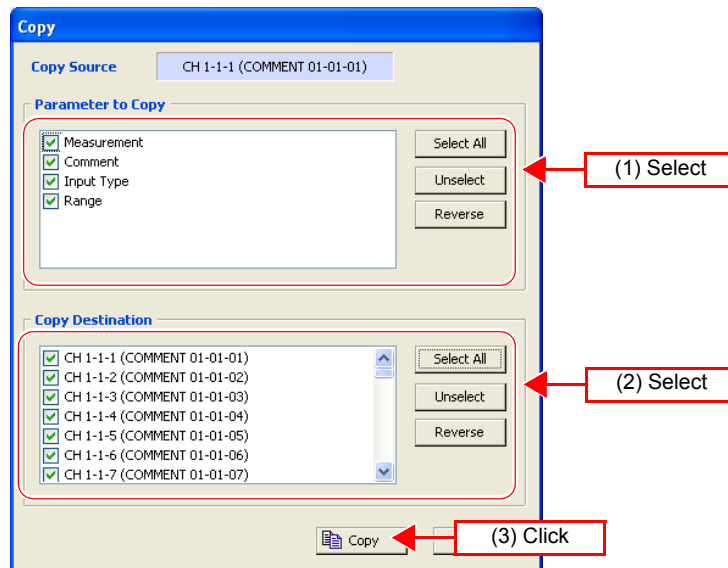

Selectable Items	Explanations
Select All	Select all the parameters to copy or copy destinations.
Unselect	Clear the selection for all the parameters to copy or copy destinations.
Reverse	Reverse the selection for the parameters to copy or copy destinations.

5.10 Narrowing Down of Display Channels

Normally, all channels are displayed on the pages for channel settings (measurement settings, display settings, and sheets), trigger settings, and alarm settings, but you can also use **[Logger]** to display channels by logger.

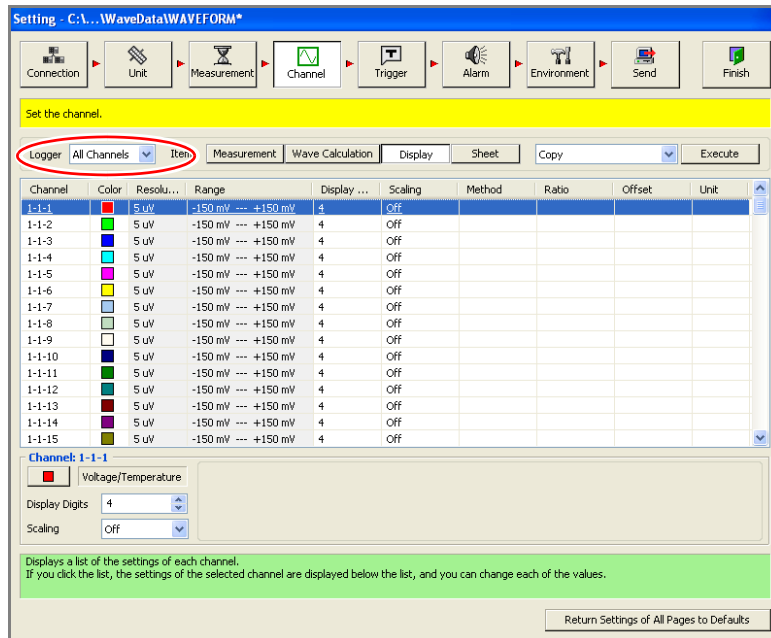
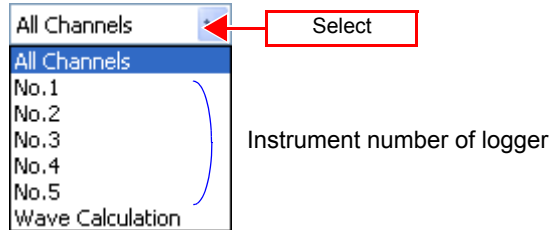

Starting and Stopping Measurement

Chapter 6

The instrument is capable of two measurement methods: computer based measurement which allows for the instrument to be controlled from a computer and data to be collected and observed in real time, and standalone measurement which allows for data to be saved to a CF card inserted in the instrument. With either of these methods, use the supplied software Logger Utility to set and send the measurement conditions.

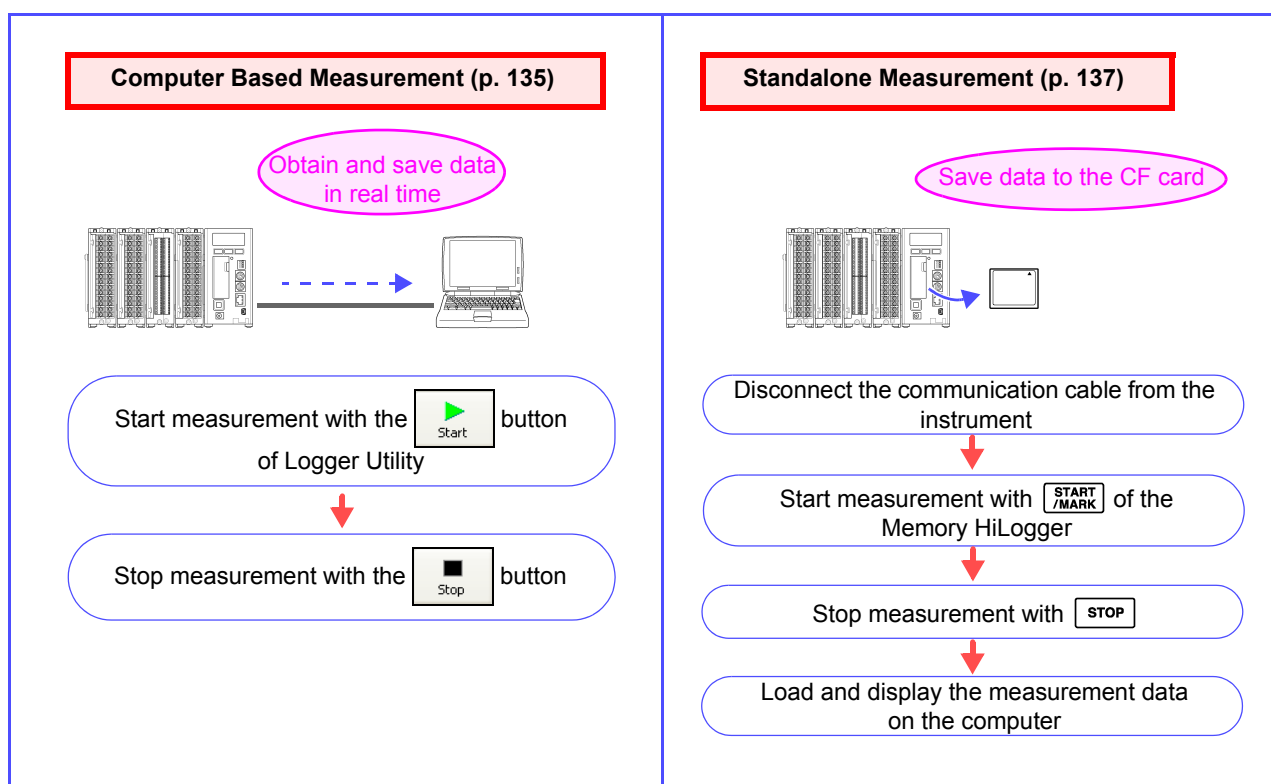

NOTE

The measurement conditions are also set and sent from a computer when you perform standalone measurement. When you have finished setting all of the measurement conditions, click the **[Send]** button in the settings screen.

To ensure measurement is performed safely, observe the following precautions.

! WARNING

- The maximum input voltage, maximum rated voltage to earth, and maximum rated voltage between channels for the input/output terminals of each unit and the external control input terminals of the 8423 Memory HiLogger main unit are as shown in the table below. To avoid an electric shock accident or damage to the instrument, do not input the corresponding voltages or above.
- Channels are isolated by semiconductor relays. Never apply a voltage in excess of the specifications between channels as doing so could damage the semiconductor relays by causing them to short out. Exercise particular care concerning surge protection against lightning and other threats. If the instrument yields erroneous measured values, have it inspected.

! CAUTION

- Do not input a voltage that exceeds the measurement range of each range. Doing so will damage the unit.
- Do not directly input a voltage into the output terminal of the 8997 Alarm Unit. Doing so will damage the unit.
- The GND of the external control input terminals and the GND of the Memory HiLogger main unit are not commonly insulated. To avoid damaging the instrument, make sure wiring is done in such a manner that no potential difference can result between the GND of the external control input terminals and the GND of the equipment or device to be connected.

Input/Output Terminals		Maximum Input Voltage	Maximum Rated Voltage to Earth	Maximum Rated Voltage between Channels
Model 8948 Input terminals		100 VDC	600 V AC/DC	200 VDC
Model 8949 Input terminals		60 VDC	600 V AC/DC	120 VDC
Model 8996 Input terminals		50 V DC	600 V AC/DC* ¹	33 Vrms or 70 VDC* ²
Model 8997 Output terminals		--	600 V AC/DC	33 Vrms or 70 VDC
External Control Input Terminals	SMPL / TRIG	-5 to 10 VDC	Not insulated	--
	START			
	STOP			

*1 Between each of the input channels 1 to 5 and the logger main unit, between each of the input channels 6 to 10 and the logger main unit, between each of the input channels 11 to 15 and the logger main unit, and between each unit

*2 Between each of the input channels 1 to 5 and each of the input channels 6 to 10, between each of the input channels 6 to 10 and each of the input channels 11 to 15, and between each of the input channels 1 to 5 and each of the input channels 11 to 15 (GND is common for each of channels 1 to 5, channels 6 to 10, and channels 11 to 15)

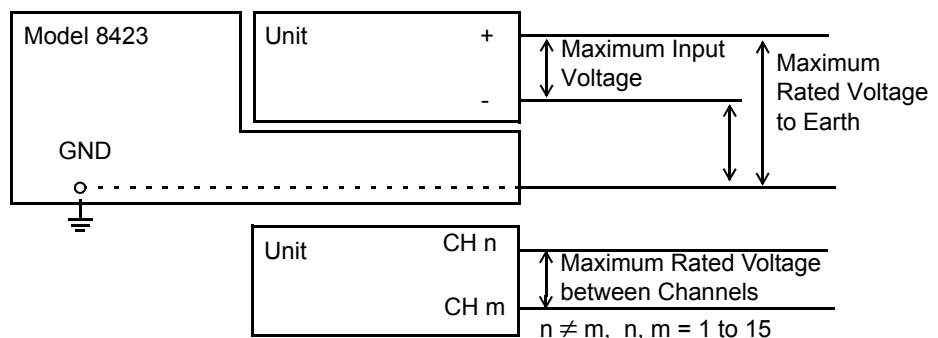

Units' circuit architecture

Model 8948 Voltage/Temp Unit and 8949 Universal Unit Input Circuit Diagram

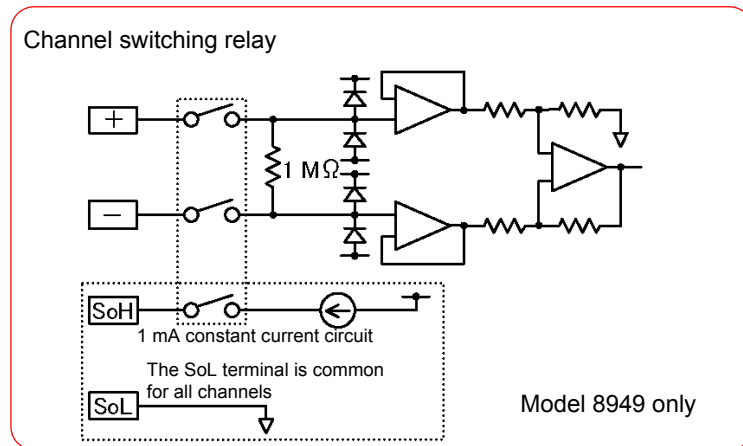

Model 8996 Digital/Pulse Unit Input Circuit Diagram

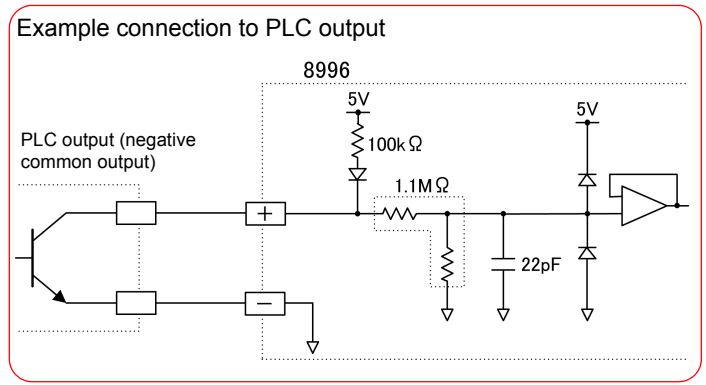
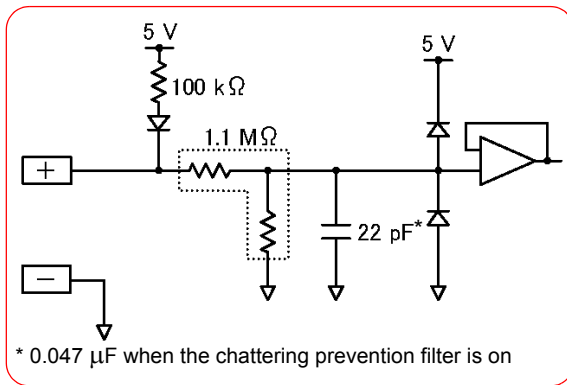

Model 8997 Alarm Unit Output Circuit Diagram

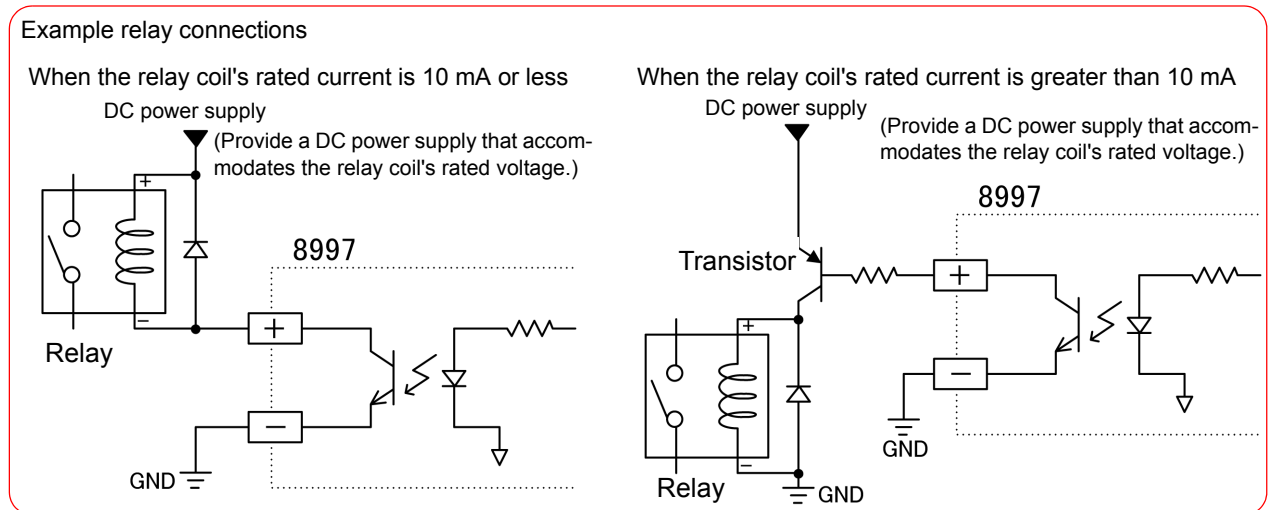
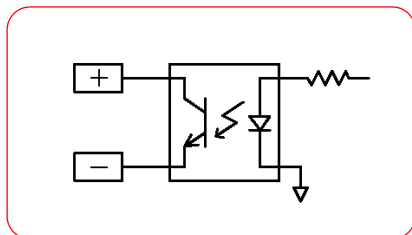

6.1 Pre-Operation Inspection

Inspect the following items before beginning measurement. Furthermore, to ensure accurate measurement, allow the equipment to warm up for 30 minutes.

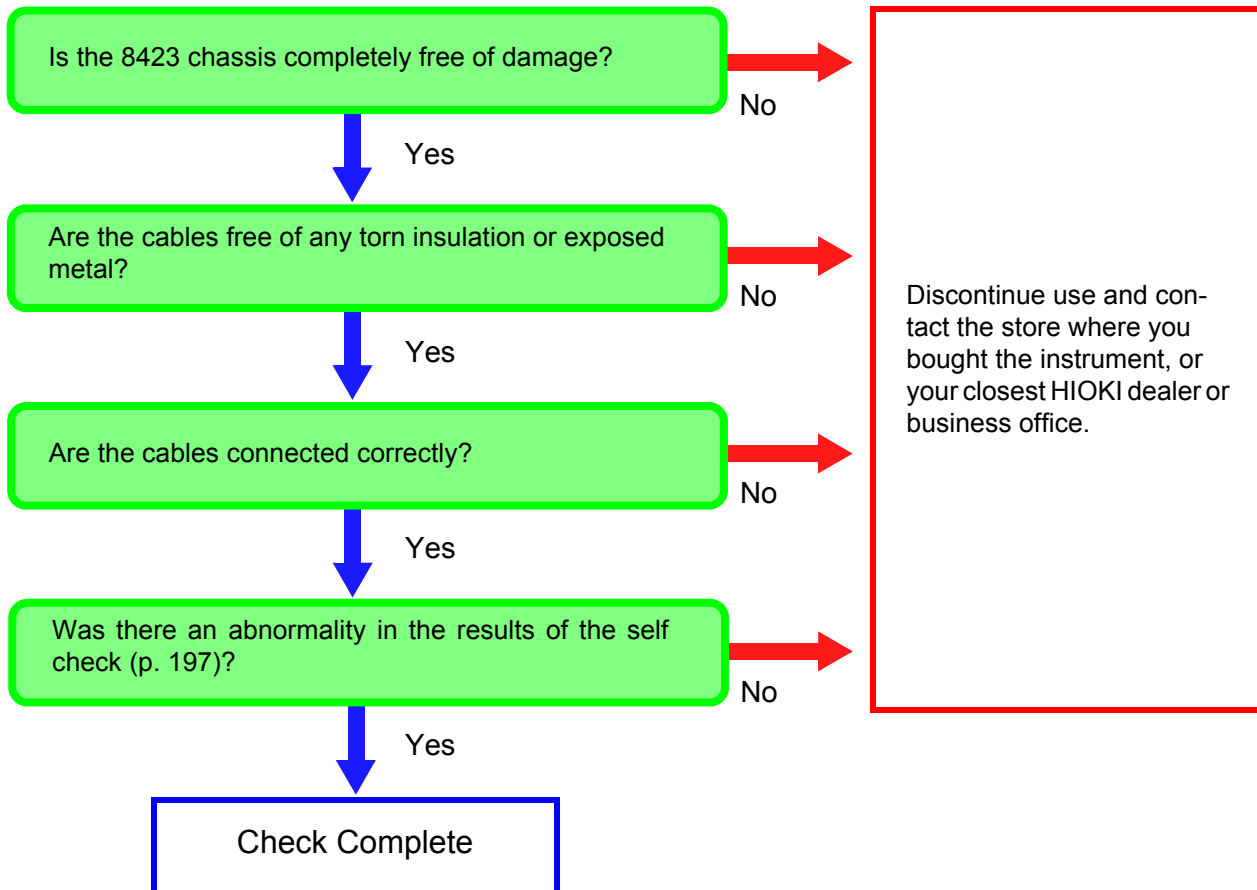
**NOTE**

Also confirm that there is no abnormality in the same way after measurement ends.

6.2 Starting and Ending Measurement

6.2.1 Computer Based Measurement

1. Click the  button in the main screen of Logger Utility to start measurement.

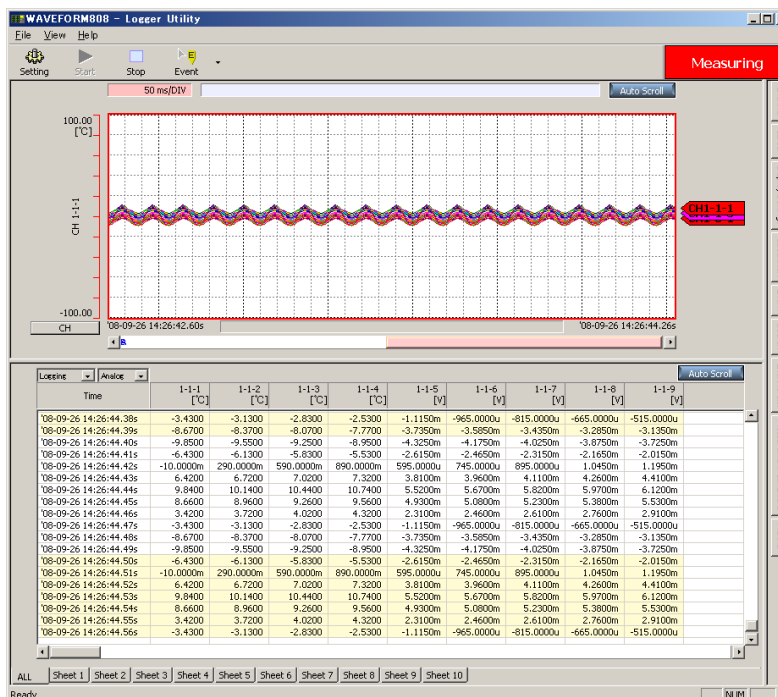

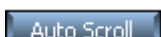
 : Scroll the waveform automatically

 : Scroll the waveform manually

2. Click the  button in the main screen to stop measurement.

When a recording period is set, measurement ends automatically when timer measurement is set.

NOTE

For computer based measurement, end all other applications. Even if the computer you are using satisfies the operating environment specifications, measurement and recording may not be able to be performed properly due to the state of the computer when, for example, other applications are open.

**Why is a waveform not displayed?**

The measurement waveform may have gone out of the display range. Change the display upper limit and display lower limit settings on the **[Channel]** tab of the display settings window to match the measurement values.

See "7.1 Changing the Waveform Display Range" (p. 140).

**How do I check the measurement value at any point of a waveform?**

Click the tool button on the main screen to display cursors A and B. You can confirm the measurement value of a specific position of a cursor on the **[Cursor]** tab of the display settings window.

See "7.2 Checking Cursor Values" (p. 141).

**How do I add graduations (scale) to the graph?**

On the **[Display Setting]** tab in the display settings window, set gauge display to ON.

See "7.3 Changing Display Settings" (p. 142).

**How do I split the waveform display area into two?**

On the **[Display Setting]** tab in the display settings window, set split screen to ON.

See "7.3 Changing Display Settings" (p. 142).

**How do I add a mark to a waveform?**

Click the tool button on the main screen to display an event mark. You can then click on the waveform to add an event mark.

See "7.5 Event Mark Function" (p. 153).

6.2.2 Standalone Measurement

1. Press **START / MARK** on the front of the instrument to start measurement.

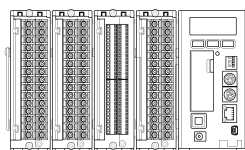

START / MARK : Lit green during measurement

Each press of **DISP** during measurement changes the display area as follows. The measurement value, number of measurement data items, and CF card remaining space indications are updated during measurement as necessary. The number of event marks indication is updated each time an event mark is added (maximum of 100).

[Measurement Value Indication] → [Measurement Data Indication] → [Number of Event Marks Indication] → [CF Card Remaining Space], and then back to [Measurement Value Indication]

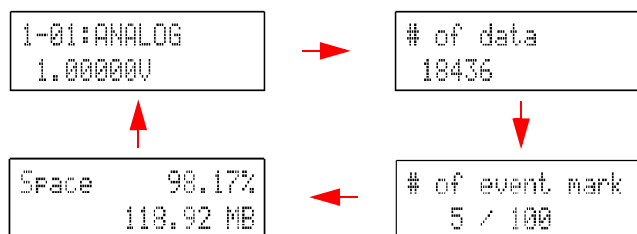

The measurement value indication switches between all of the channels set to ON at an interval of approximately 1 second. Channels for which measurement is not set to ON are skipped. If scaling is set, the conversion value and unit are displayed.

Display example when scaling is set

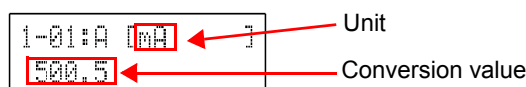

When the input type in the 8996 Digital/Pulse Unit is set to logic, all channels are displayed simultaneously.

Logic display example

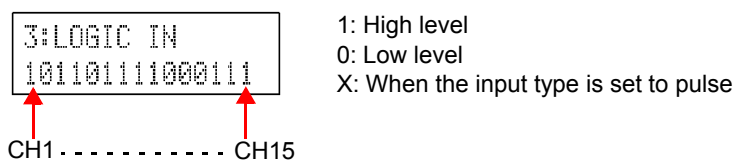

When the 8997 Alarm Unit is connected and the alarm function is set, the alarm status of all channels is display simultaneously.

Alarm status display example

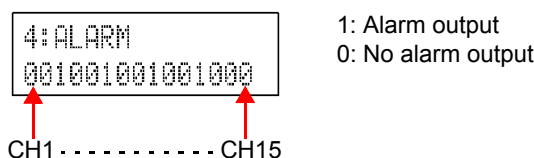

6.2 Starting and Ending Measurement

NOTE

Even if a channel comment is set with the supplied software Logger Utility, it is not displayed in the display area of the instrument.

2. Press **STOP** twice to stop measurement.

When a recording period is set, measurement ends automatically when timer measurement is set.

Each press of **DISP** when measurement is stopped changes the display area as follows.

[Date and Time Indication] → [Measured Data Indication] → [CF Card Remaining Space] → [Serial No.] → [IP Address] → [MAC Address], and then back to [Date and Time Indication]

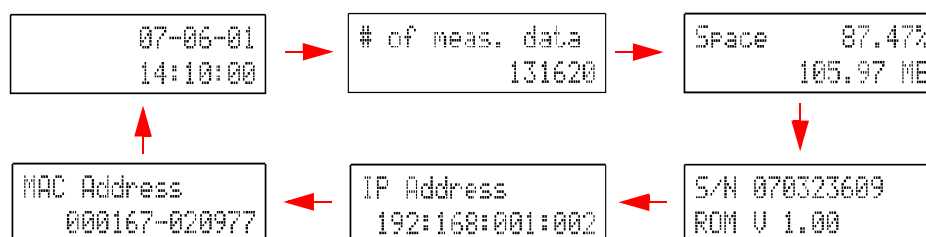

How do I add a mark to a waveform?

Press the **START/MARK** key during the measurement to add the event mark. (Max. 100 marks)



How do I fix the measurement value display channel?

While measurement values are being displayed during measurement, press **DISP** for at least one second and then release **DISP** to fix the display channel to that displayed the instant the key was released. Press **DISP** for at least one second again to cancel fixing of the display channel.

Analyzing Measurement Data

Chapter 7

Click a tab on the right side of the main screen to display a settings display window. These windows allow for configuring the advanced settings of the waveform display area, analyzing data, etc.

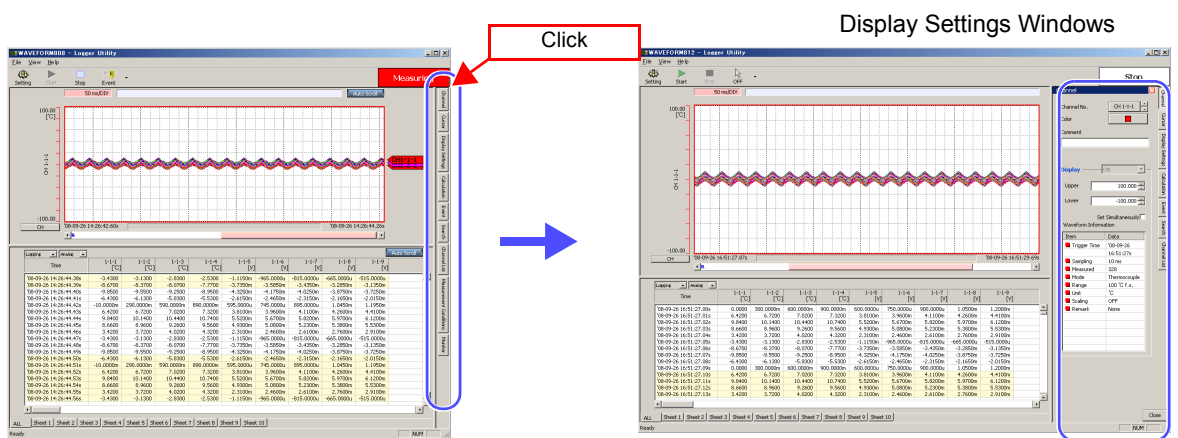

[Channel] tab:
Changing the Waveform Display Range (p. 140)

[Cursor] tab:
Check the measurement values at the locations of the cursors A and B (p. 141)

[Display Setting] tab:
Configure the display settings of the main screen (p. 142)

[Calculation] tab:
Calculate the maximum value and minimum value of a waveform, etc. (p. 150)

[Event] tab:
Event Mark Function (p. 153)

[Search] tab:
Add a mark to a waveform or search for a mark (p. 155)

[Channel List] tab:
Display the display color of each channel (p. 159)

During measurement only **[Measurement Conditions]** tab:
Display the measurement start time, number of data items, etc. (p. 160)

During measurement only **[Monitor]** tab:
Display the instantaneous value of each channel (p. 161)

7.1 Changing the Waveform Display Range

Measurement data cannot be checked in the waveform display area if it goes out of the display range. In such a case, change the display upper and lower limits on the [Channel] tab. You can also change the waveform color, comment, and other items.

1. Click the [Channel] tab on the right side of the main screen to open the settings window.
2. Select the channel for which to change the settings by selecting the instrument, unit, and then channel.

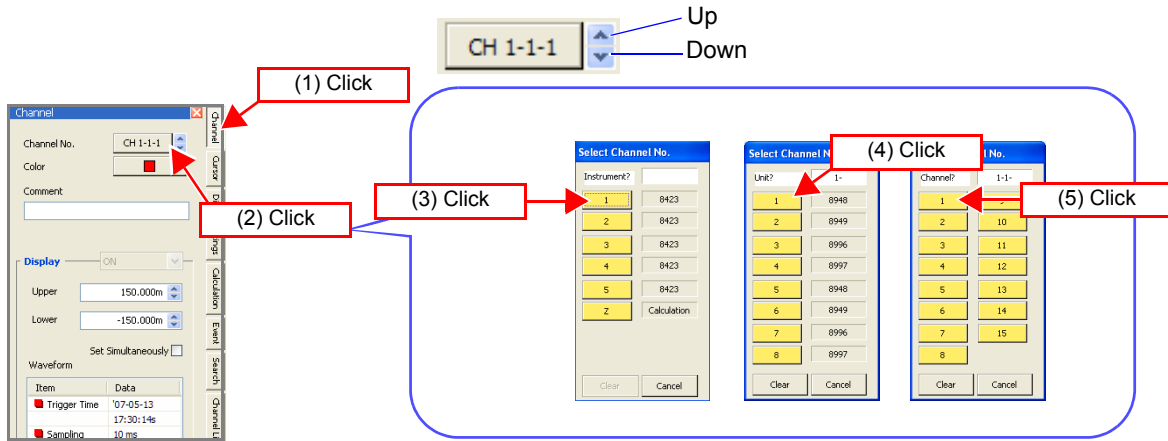

3. Set waveform display to ON, and set the display upper limit and display lower limit.

When the sheet is ALL, the ON/OFF setting of display is not available.

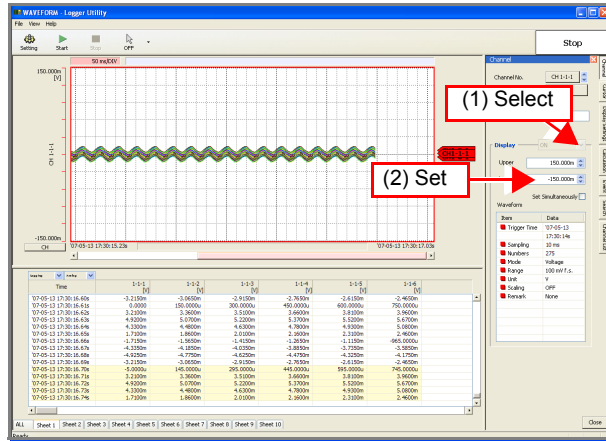

(Gauge display is ON in this figure)

To directly input the display upper limit and lower limit values, press the Enter key on the keyboard each time after each value has been inputted to set it.

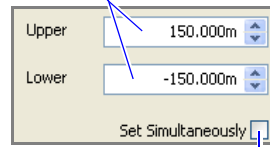

If you want to increase/decrease both the display upper limit and lower limit at the same time, add a check here. If the scale difference between the upper value and lower value is large, the values may not be able to be increased/decreased at the same time.

4. If you want to change the waveform color, select the desired color from the [Color] dialog box. Selecting a color that makes the waveforms easy to see is recommended.

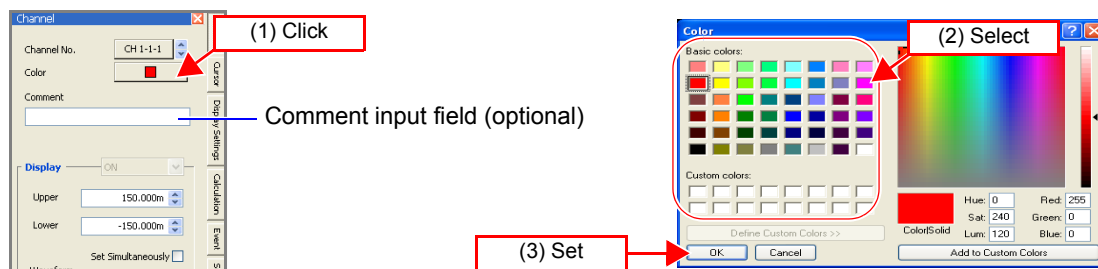

7.2 Checking Cursor Values

You can use both cursors (cursors A and B) to check measurement values.

1. Click the [Cursor] tab on the right side of the main screen to open the settings window.
2. Add a check for the cursor to use to display the selected cursor in the waveform display area.

When checked, the conditions of the alarm channel will also be displayed on the list.
 1: Alarm activated
 0: Alarm not activated

3. Select the channels for cursor measurement, and then scroll the cursor to display measurement values.

When the knob of the scroll bar below the list is moved, the difference in measurement value between cursors A and B will be displayed.

Selectable Items	Explanations
All Channels	Display the values of all channels.
Sheet	Display the values of channels in the sheet currently displayed.
Selected	Display the values of the selected channel.

When the mouse operation button is , you can move the mouse to a cursor on the screen to display the ⇄ mark, and then move the selected cursor by dragging. When the mouse operation button is

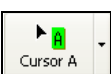
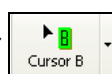
 or , clicking on the screen moves the cursor to the clicked position.

7.3 Changing Display Settings

You can switch the display in the main screen and configure settings such as the display format.

7.3.1 Switching between Waveform Display and List Display

You can switch the measurement data display method of the main screen between waveform display, list display, and waveform plus list display.

1. Click the [Display Setting] tab on the right side of the main screen to open the settings window.
2. Each click of the [Switch] button switches the display of the main screen.

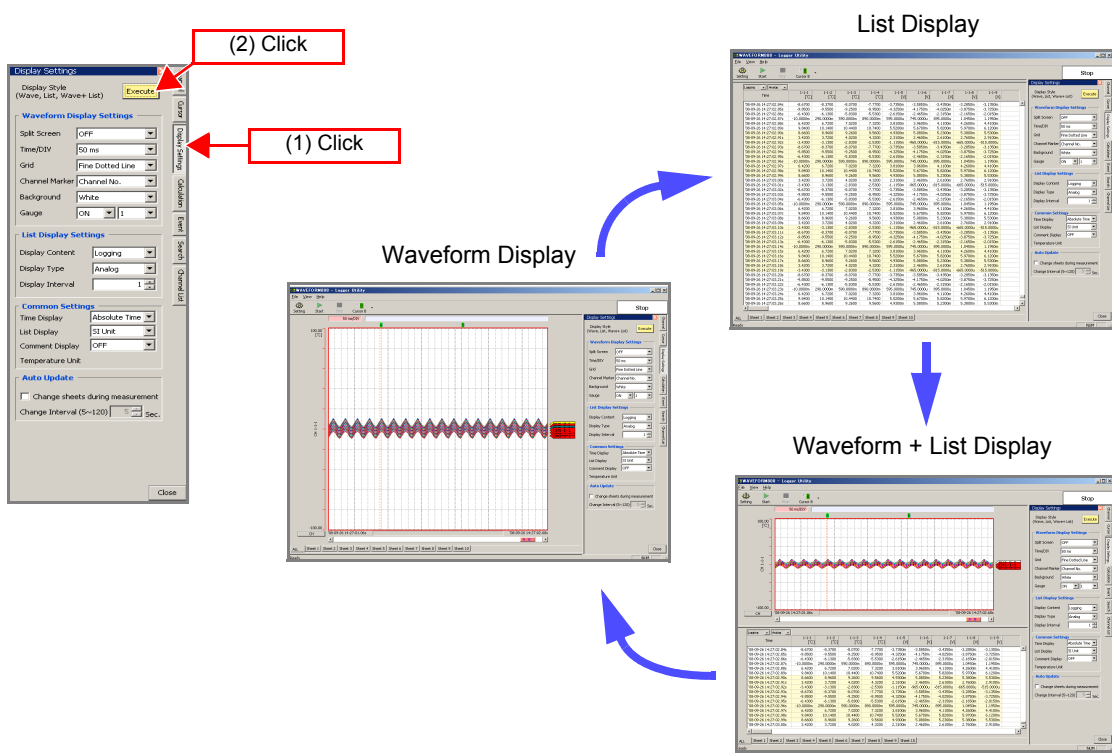

Selectable Items	Explanations
List Display	Displays waveform data as numerical values. It is also possible to display calculation results.
Wave Display	Displays measured waveforms.
Wave + List Display	Displays both the waveform display and list display in one screen.

7.3.2 Waveform Display Settings

This section describes setting the display format of the waveform display area.

1. Click the [Switch] button to switch to waveform display or waveform plus list display.
2. Set various waveform display settings.

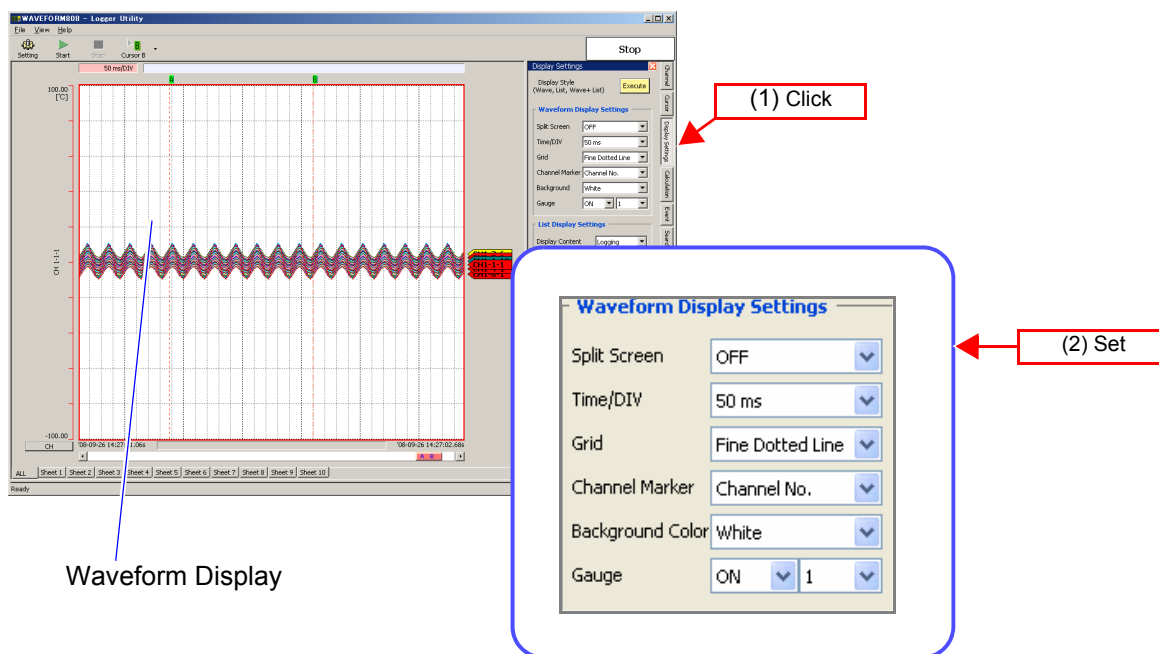

Waveform Display

Split Screen

The waveform display area can be split into two screens.

Selectable Items	Explanations
ON	Displays two waveform screens.
OFF	Displays one waveform screen.

Split Screen OFF

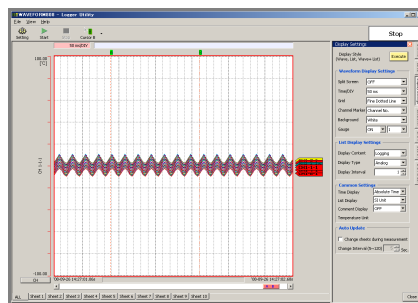

Split Screen ON

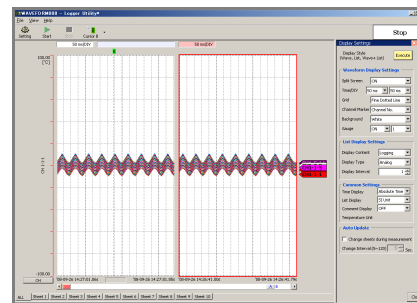

Time/1 Square

Set the time axis (time per square) of the waveform display area.

Selectable Items
50 ms, 100 ms, 200 ms, 500 ms, 1 s, 2 s, 5 s, 10 s, 20 s, 30 s, 1 min, 2 min, 5 min, 10 min, 20 min, 30 min, 1 hour, 2 hour, 5 hour, 10 hour, 12 hour, 1 day, 2 day

When split screen is ON, you can set the time axis of each of the screens.

7.3 Changing Display Settings

Display Grid

You can select from the following grid types for the waveform display area.

Selectable Items
None, Dotted Line, Solid Line, Fine Dotted Line, Fine Solid Line

Dotted Line

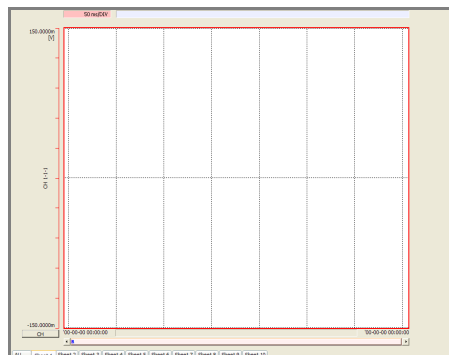

Solid Line

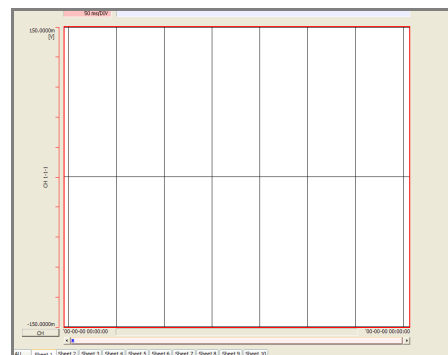

Fine Dotted Line

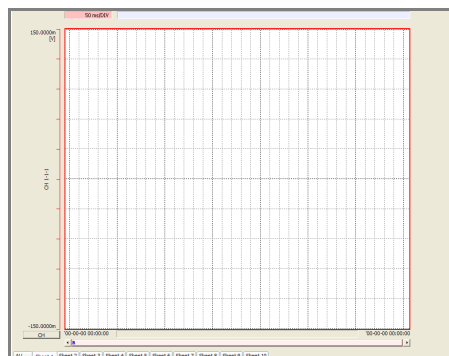

Fine Solid Line

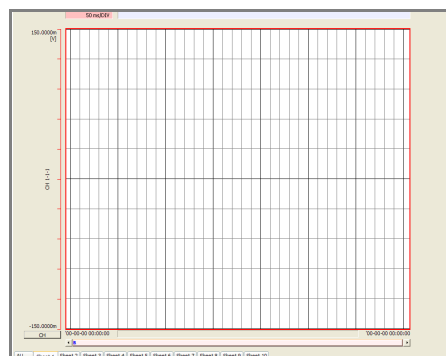

CH Marker

You can select the item to display on the right side of the waveform display area from the following items.

Selectable Items	Explanations	Display Examples
OFF	Do not display a channel mark.	Non
CH Number	Display the channel number.	◀ CH1-1-1
Comment	Display the comment.	◀ COMMENT
CH & Comment	Display the channel number and comment.	◀ 1-1-1:COMMENT

If the comment is long, not all of the characters are displayed on the CH marker.

Waveform
Background
Color

You can select black or white for the background color of the waveform display area.

Gauge Display
Quantity

You can display a gauge (graduations) on the left side of the waveform display area.

Selectable Items	Explanations
ON	Display a gauge on the left side of the waveform display area. When display of the gauge is ON, you can select a number from 1 to 8. The highest value is the display upper limit and the lowest value is the display lower limit, and the settings can be changed on the [Channel] tab.
OFF	Do not display a gauge.

Display Gauge ON

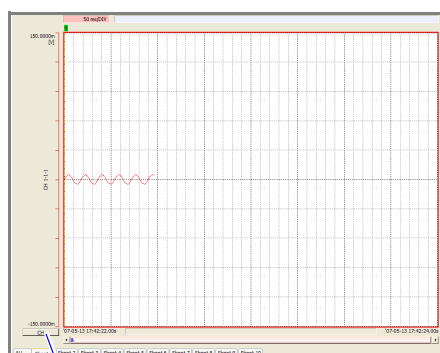

Display Gauge OFF

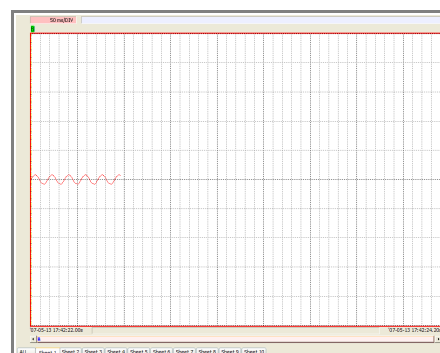

The channel for each gauge can be set by clicking the **[CH]** button displayed at the bottom of the gauge.

Confirming Position of Displayed Waveform Portion with Scrollbar

You can use the scrollbar to confirm what the position of the waveform portion displayed on the screen is within the whole recorded waveform. **The scrollbar has two knobs**, and color is used to emphasize the active knob. The positions of the cursors A and B are also indicated.

When One Screen (Split Screen OFF)

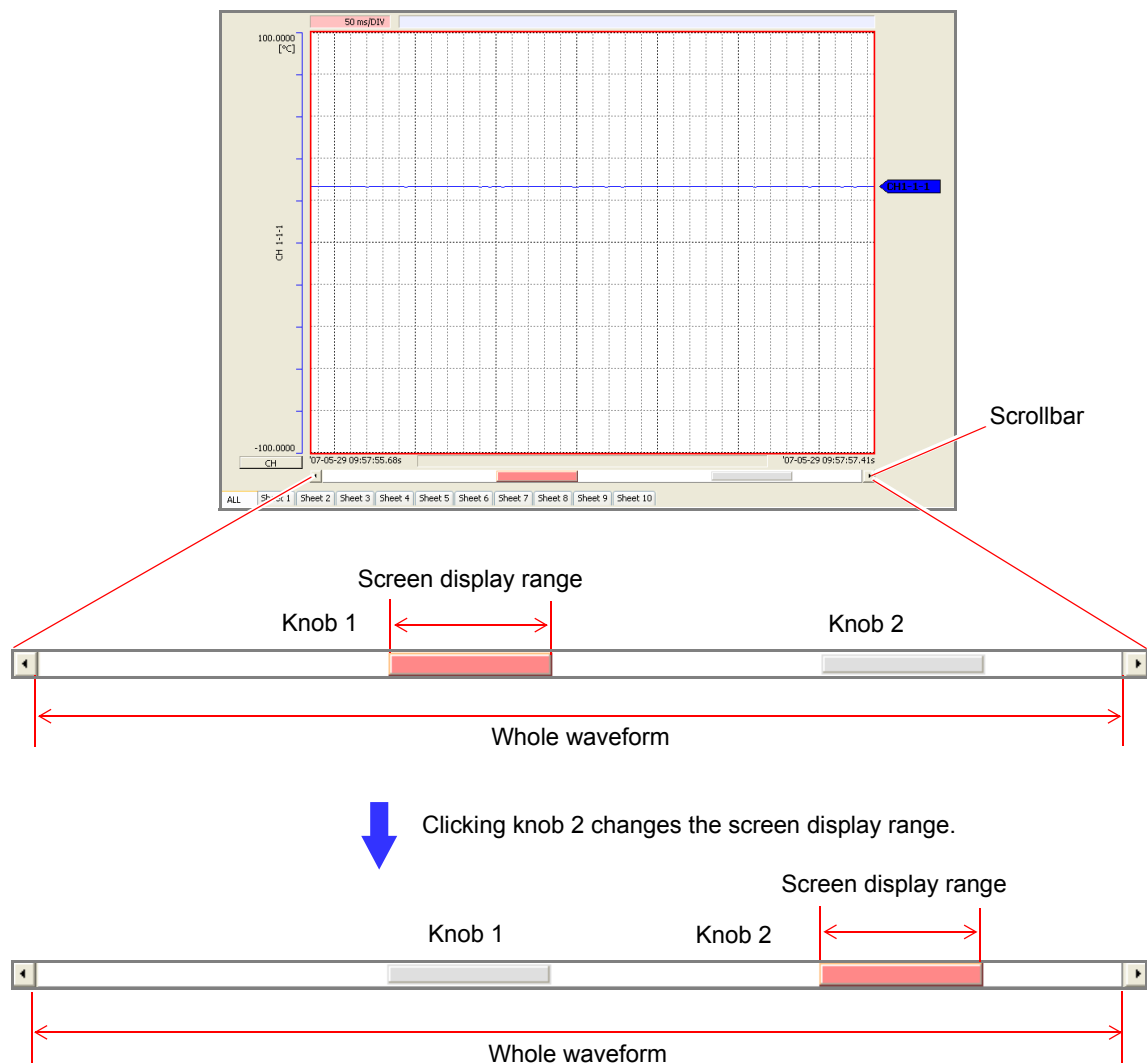

When Two Screens (Split Screen ON)

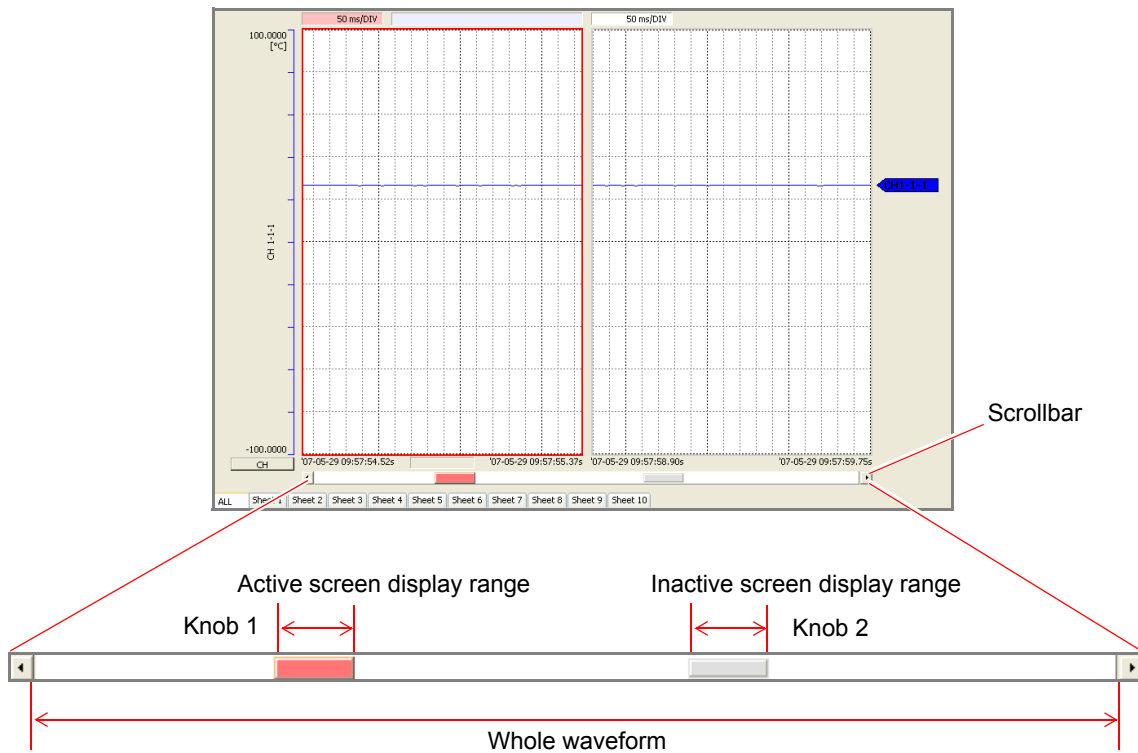

Confirming Positions of Cursors with Scrollbar

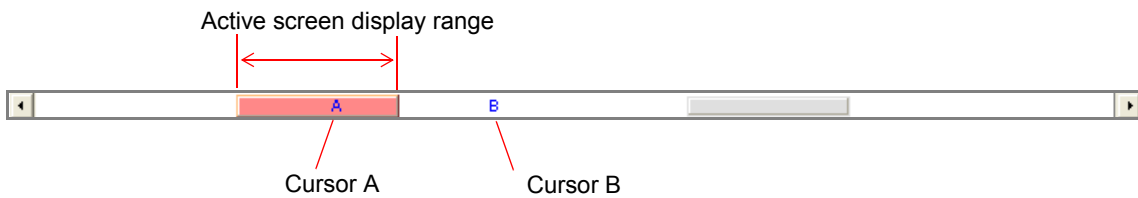

7.3.3 List Display Settings

This section describes setting the display format of the list display area.

1. Click the [Execute] button to switch to list display or waveform plus list display.
2. Set various list display settings.

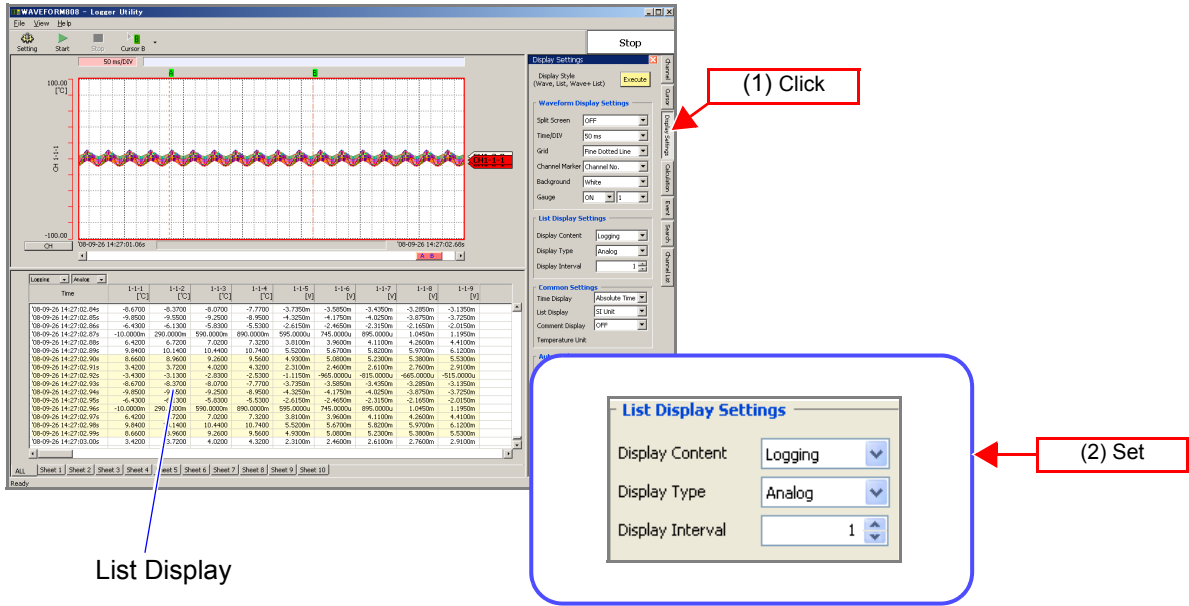

Display Content You can select the content of the list display area.

Selectable Items	Explanations
Logging	Display measurement values in the list display area. When logging is selected, set the display type and display interval (thinning interval) for the selected sheet.
Calculation	Display list calculation results in the list display area.

Display Type (When logging is selected for the display content)

Selectable Items	Explanations
Analog	Display analog data only.
Logic	Display logic data only.
Alarm	Display alarm data only.
Wave Calculation	Display waveform calculation data only.
All	Display all data.

Display Interval (When logging is selected for the display content)
Selection range: 1 to 1000

7.3.4 Common Settings and Auto Update Settings

This section describes setting common settings related to display screens.

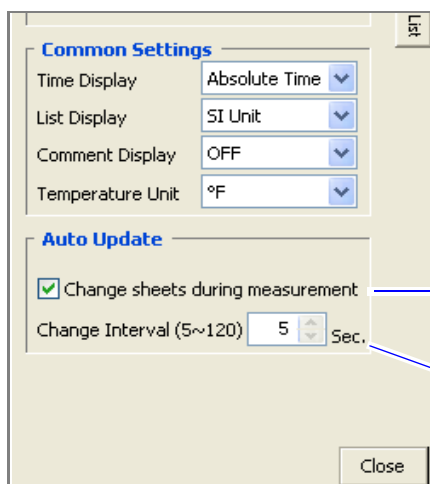

Add a check here when you want to switch display sheets at a switch interval during measurement.

Set a switch interval from 5 to 120 seconds.

Time Display

Select the display format for time values.

Selectable Items	Explanations	Examples
Absolute Time	Display the global time (date).	'07-01-01 00:10:00.00s
Relative Time	Display the time since the start of measurement in sexagesimal.	00:10:00.00s
Second	Display the time since the start of measurement in seconds.	6.000 ks
Point	Display the number of measurement points since the start of measurement.	6000000

Numerical Display

Select the display format for measurement values.

Selectable Items	Explanations	Examples
SI Unit	Display values with a supplementary unit added (k, m, etc.).	1.000 mV
Decimal	Display values in decimal.	0.001 V
Exponential	Display values in exponential.	1.000E-03

Set the number of digits to display after the decimal point on the channel settings page of the settings dialog box.

Comment Display

Set whether a comment is displayed.

Selectable Items	Explanations
ON	Displays the channels of the value display part using comments. The channel number is displayed for channels that do not have a comment set.
OFF	Displays the channels of the value display part using CH number.

Temperature Display

Set whether a temperature display is displayed.

Selectable Items	Explanations
°C	Display a temperature unit with a centergrade unit (°C).
°F	Display a temperature unit with a fahrenheit unit (°F) by scaling function.

7.4 Calculations

This section describes performing calculations on the measurement data within the whole range or between the cursors A and B. (Calculations can be performed during measurement or after measurement.)

7.4.1 Calculation Settings

1. Click the [Calculation] tab on the right side of the main screen to open the settings window.
2. Select [All Channels] or [Display Sheet] for the calculation channels.
3. Select [Whole Range] or [Between A - B] as the calculation range.
Setting [Between A and B] as the calculation range allows you to select [Auto Calculation].
4. Select ON or OFF for the calculation filter.
Setting ON allows you to avoid incorrect calculations caused by noise.

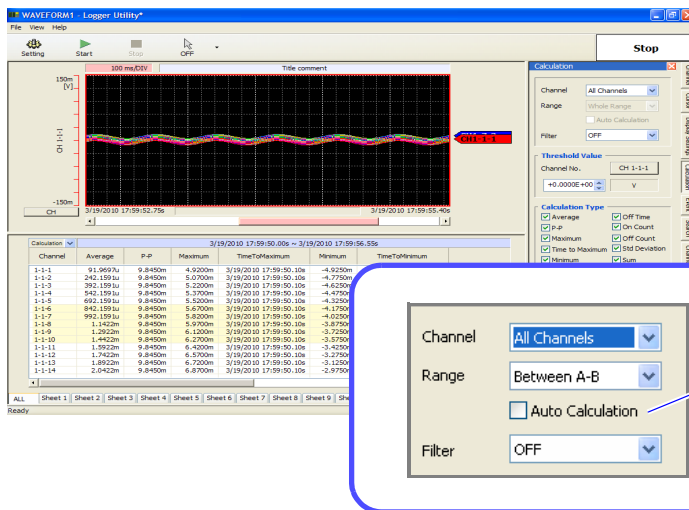

(1) Click

(2) Set

If the calculation range is between A and B, you can add a check here to enable calculations to be performed automatically when the cursors A and B are moved.

5. Select a channel and set the threshold.

The threshold value is only valid when checks are added to On Time, Off Time, On Count, or Off Count.

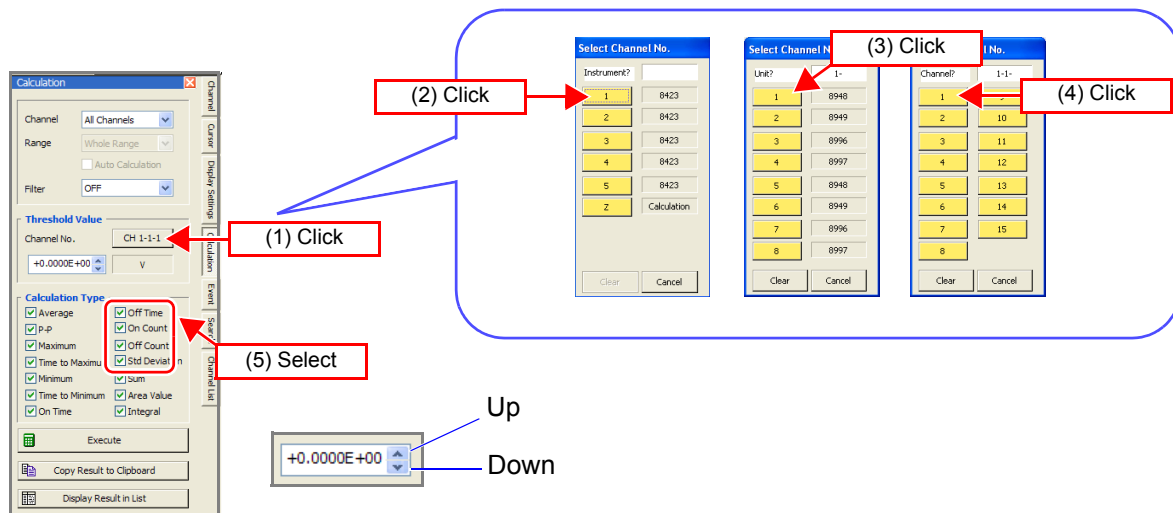

(1) Click

(2) Click

(3) Click

(4) Click

(5) Select

Up

Down

6. Select the calculation to perform.

Selectable Items
Average, P-P, Maximum, Time to Maximum, Minimum, Time to Minimum, On Time, Off Time, On Count, Off Count, Std Deviation, Integral, Area Value, Integration

Selectable Items	Explanations
On Count	Display the number of times measurement values crossed over the set threshold value.
Off Count	Display the number of times measurement values crossed under the set threshold value.
On Time	Obtain the total time that measurement values were larger than the set threshold value.
Off Time	Obtain the total time that measurement values were smaller than the set threshold value.

(The calculations above are not possible with pulse.)

7. Click the [Calculate] button to perform the calculation for the selected range.

The list display area displays the calculation.

If a calculation is performed for the **[Whole Range]** calculation range during measurement, the calculation is performed for the range from the start of measurement to the point in time the **[Calculate]** button is pressed.

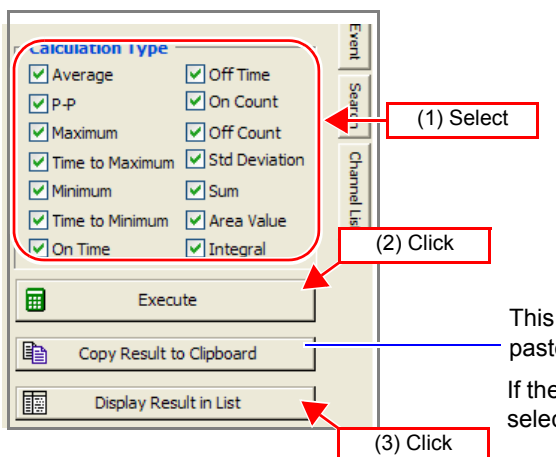

This button copies the calculation result to the clipboard. You can paste the copied data into a Notepad, Word, or other document.

If the list display area is not displayed because logging display is selected, this button switches the display to calculation display.

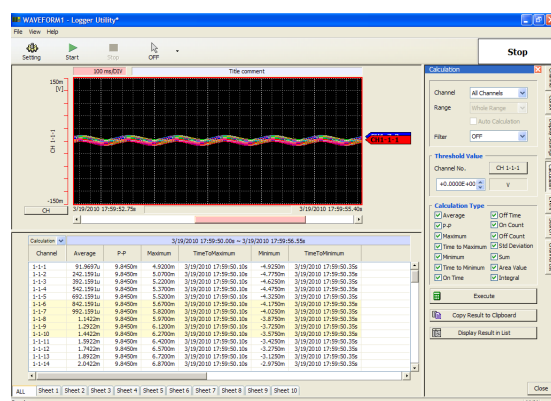

NOTE

- When the calculation range is set to **[Between A and B]** and only one cursor is displayed, the calculation range is from the cursor display position to the end of the data.
- A calculation is not performed in real time during measurement. It is only performed when the **[Calculate]** button is clicked, or when the cursors A and B are moved while **[Auto Calculation]** is set for **[Between A and B]**.

7.4.2 Numerical Calculation Expressions

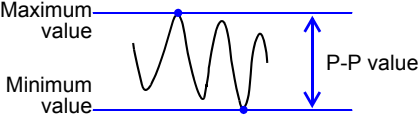
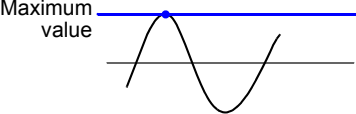
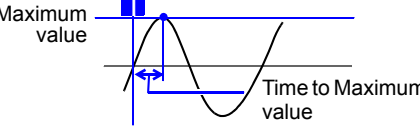
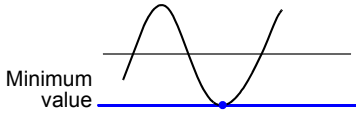
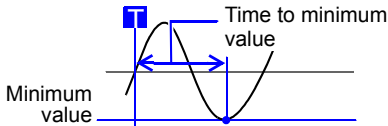
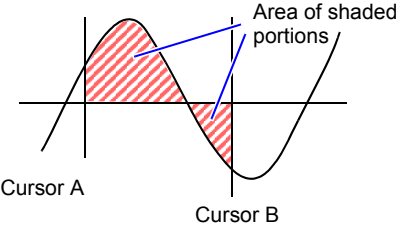
Calculation Type	Description
Average	<p>Obtains the average value of waveform data.</p> $AVE = \frac{1}{n} \sum_{i=1}^n di$ <p> <i>AVE</i> : Average value <i>n</i> : Data count <i>di</i> : Data on channel number i </p>
Peak-to-Peak (P-P) Value	<p>Obtains the value of the difference (peak-to-peak value) between maximum and minimum values of waveform data.</p> 
Maximum Value	<p>Obtains the maximum value of waveform data.</p> 
Time to Maximum Value (Time to Max)	<p>Calculate the time (s) from the trigger point to the maximum value. If the maximum value occurs in two or more instances, the first instance is treated as the maximum value.</p> 
Minimum Value	<p>Obtains the minimum value of waveform data.</p> 
Time to Minimum Value (Time to Min)	<p>Calculate the time (s) from the trigger point to the minimum value. If the minimum value occurs in two or more instances, the first instance is treated as the minimum value.</p> 
Standard Deviation (Std Deviation)	<p>Obtains the standard deviation of the waveform data.</p> $\sigma = \sqrt{\frac{1}{n} \sum_{i=1}^n (di - AVE)^2}$ <p> <i>σ</i> : Standard Deviation <i>AVE</i> : Average <i>n</i> : Data count <i>di</i> : Data on channel number i </p>
Area	<p>Obtains the area value (V•s) enclosed by the zero position (point of zero potential) and the signal waveform. When calculation of the range specified by the A/B cursors is selected, the calculated area is constrained to the waveform between the cursors.</p>  $S = \sum_{i=1}^n di \cdot h$ <p> <i>S</i> : Area <i>n</i> : Data count <i>di</i> : Data on channel num <i>h</i> = Δ<i>t</i> : Sampling period </p>
Integration	<p>Calculate the totalization value of the signal waveforms.</p> $SUM = \sum_{i=1}^n di$ <p> <i>SUM</i> : Totalization value <i>n</i> : Total number of data items <i>di</i> : Data on channel number i </p>
Integral	<p>Calculate the integral of the signal waveforms.</p> $INT = \sum_{i=1}^n di \times \Delta t$ <p> <i>INT</i> : Integral value <i>n</i> : Total number of data items <i>di</i> : Data on channel number i Δ<i>t</i> : Sampling period </p>

NOTE

- When Scaling is enabled, calculations are performed after waveform data has been scaled. Also, the units of parameter values should match the scaling units.
- See "Scaling Function" (p. 98).

7.5 Event Mark Function

7.5.1 Adding a Mark (Event Mark) to a Waveform

You can use the event mark function to add an event mark to any portion of a waveform.

1. Switch the mouse operation button of the tool buttons to [Event].

If the icon is not the event mark, click the type of event mark (No. 1 to No. 20) you want to insert from the menu for [Insert Event Mark].

2. Moving the mouse cursor within the waveform display area and clicking the mouse on the location you want during measuring or after measuring will display the event mark at the top part of the waveform display area.

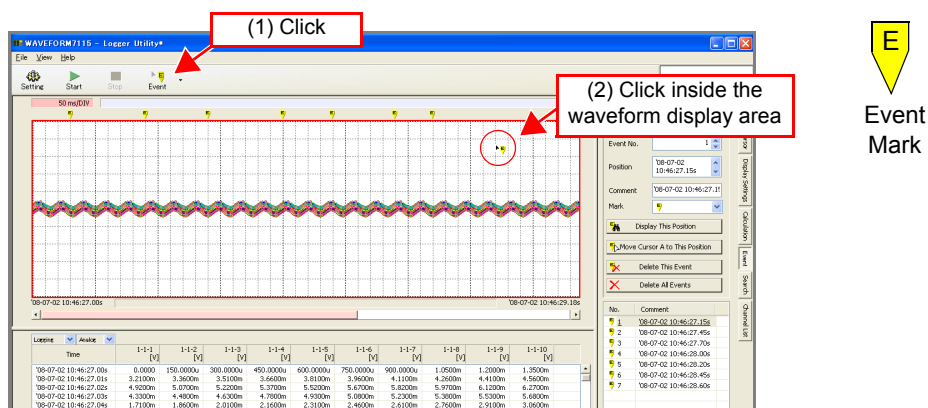

3. If you want to change the illustration of the event mark to be inserted, click the [Event] tab and select an illustration.

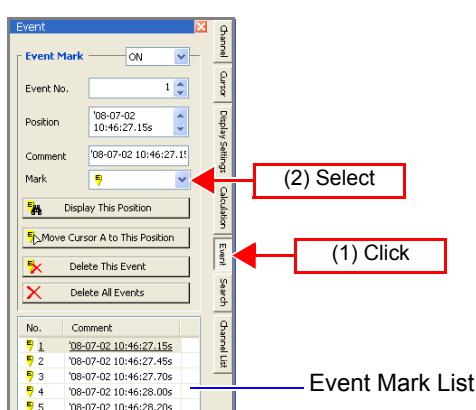

NOTE

- You can also add an event mark by pressing **START/MARK** on the logger during measurement. If there are already 100 event marks added, Logger Utility is not notified of an event if **START/MARK** is pressed.
- The maximum number of event marks that can be saved to the logger unit is 100.
- The maximum number of event marks that can be saved with Logger Utility is 1000.
- The logger main unit is not notified of an event mark that is inserted with Logger Utility.

7.5.2 Searching for and Editing Event Marks

You can search for event marks.

1. Click the [Event] tab on the right side of the main screen to open the settings window.
2. Set event mark to ON.

(2) Click

(1) Click

Event Mark List

Selected event mark and its position

Comment input field (optional)

You can select the illustration of the event mark.

No.	Comment
1	'08-07-02 10:46:27.15s
2	'08-07-02 10:46:27.45s
3	'08-07-02 10:46:27.70s
4	'08-07-02 10:46:28.00s
5	'08-07-02 10:46:28.20s
6	'08-07-02 10:46:28.45s
7	'08-07-02 10:46:28.60s
8	'08-07-02 10:46:28.85s

3. When an event mark is selected from the event mark list and the [Display This Position] button is clicked, the instrument will locate the specified event mark that is specified, jumps to its position and displays the waveforms. This function can also be performed by double-clicking the event mark on the event mark list.

(2) Click

(1) Click

This button moves cursor A to the position of the selected event mark. (This operation can also be performed by right double-clicking an event mark in the list.)

This button deletes the selected event mark.

This button deletes all event marks.

No.	Comment
1	'08-07-02 10:46:27.15s
2	'08-07-02 10:46:27.45s
3	'08-07-02 10:46:27.70s
4	'08-07-02 10:46:28.00s
5	'08-07-02 10:46:28.20s
6	'08-07-02 10:46:28.45s
7	'08-07-02 10:46:28.60s
8	'08-07-02 10:46:28.85s

7.6 Searching for the Maximum Value, Minimum Value, and Variation

This section describes searching for the maximum value, minimum value, variation, etc.

1. Click the [Search] tab on the right side of the main screen to open the settings window.
2. Select the search range.

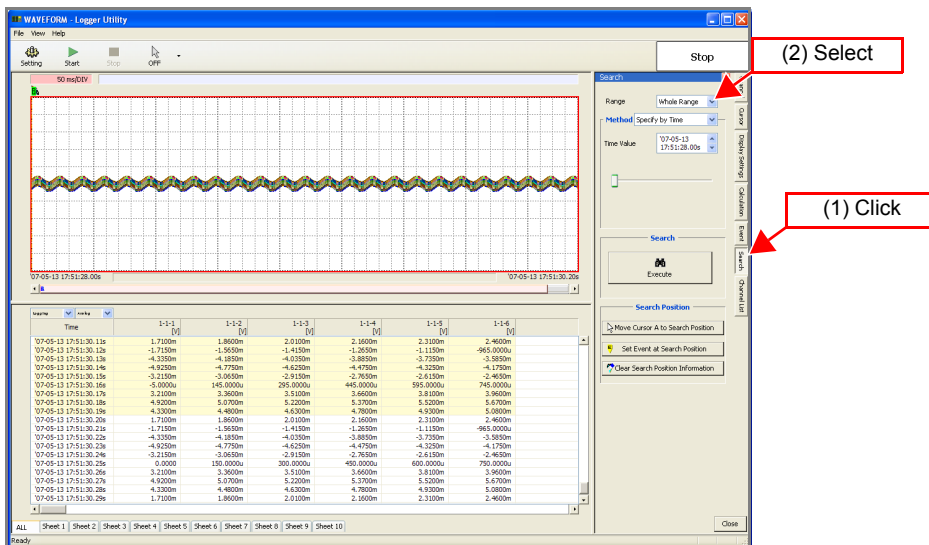

Selectable Items	Explanations
Whole Range	<p>Search the whole range of the recorded waveform.</p>
Between A-B	<p>Search the waveform portion between cursor A and cursor B of the recorded waveform.</p> <p>When you are just using either cursor A or cursor B, the search range is from the cursor to the end of the waveform.</p>

7.6 Searching for the Maximum Value, Minimum Value, and Variation

3. Select the search method and click the [Search] button.

Jumps to position where search conditions are fulfilled and displays the waveforms. Displays search marker at the position that is searched.

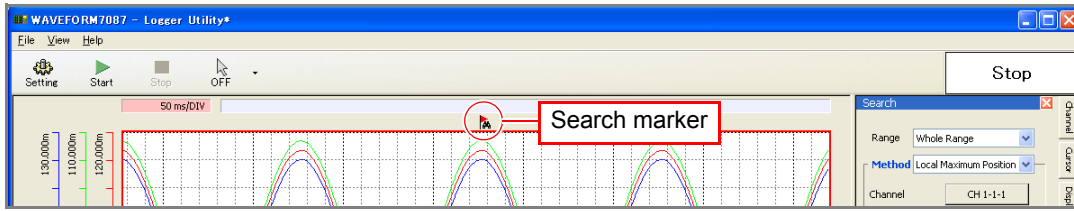

Selectable Items
Specify by Time, Maximum Position, Minimum Position, Local Maximum Position, Local Minimum Position, Alarm Position, Level, Window, Variation

The setting items above differ depending on the content selected.

Maximum Position/ Minimum Position Search for the maximum value or minimum value of any channel (channel 1-1-1 in this example).

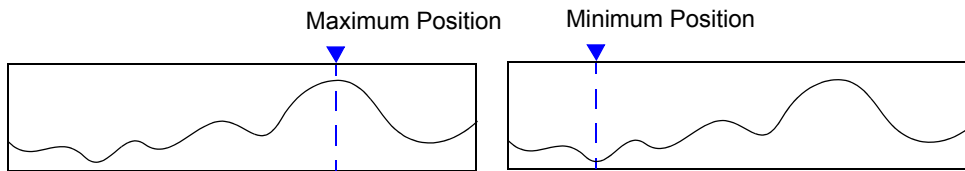

Specify by Time Specify a time to search.

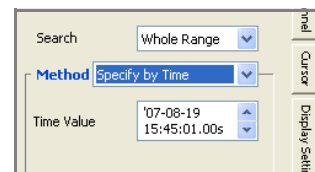

7.6 Searching for the Maximum Value, Minimum Value, and Variation

Local Maximum Position/
Local Minimum Position

Search for the maximum value or minimum value near the reference value.

- The initial reference value is the measurement start point.
- The previous search position becomes the reference point once a search has been performed.

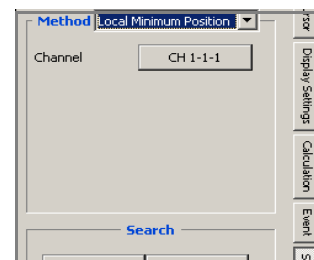
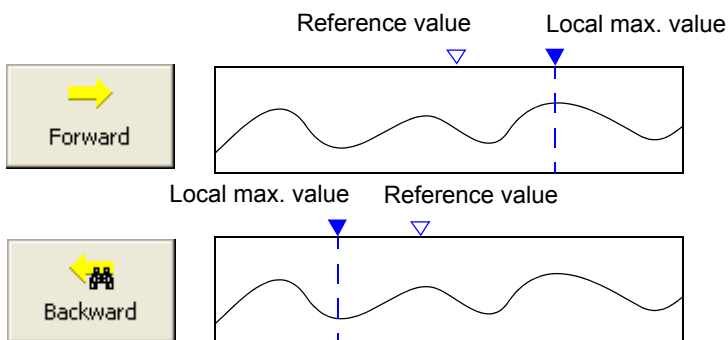

Alarm Position

Search for the position that the alarm status became ON, or the position that it became OFF. (When an 8997 Alarm Unit is connected, and alarm measurement is set to ON)

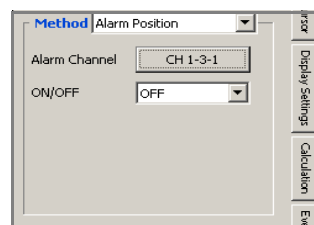
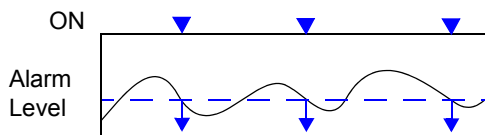

Level

Search for a portion where any channel measurement value crosses the specified value.

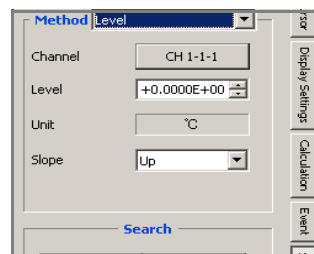
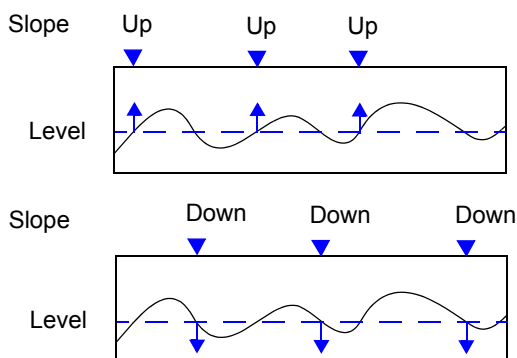

Window

Search for the portion where any channel value enters (or exits) the specified range.

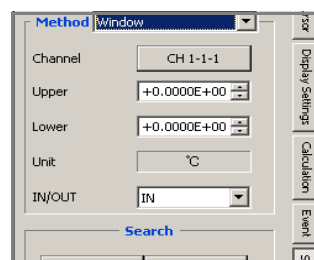
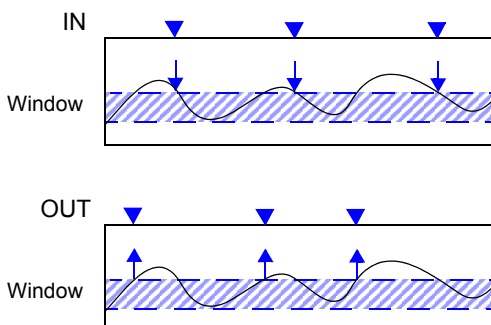

7.6 Searching for the Maximum Value, Minimum Value, and Variation

Variation

Search for a portion where the any channel value increases or decreases more than the specified variation (slope).

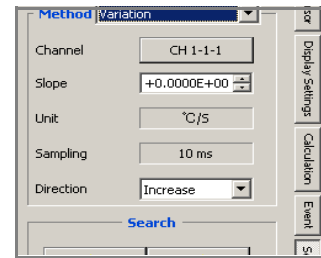
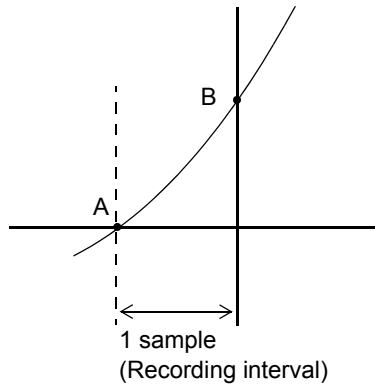

7.7 Displaying the Channel List

The channel list allows you to check information such as the waveform color of each channel. You can also reduce the number of display channels.

1. Click the [Channel List] tab on the right side of the main screen to open the settings window.

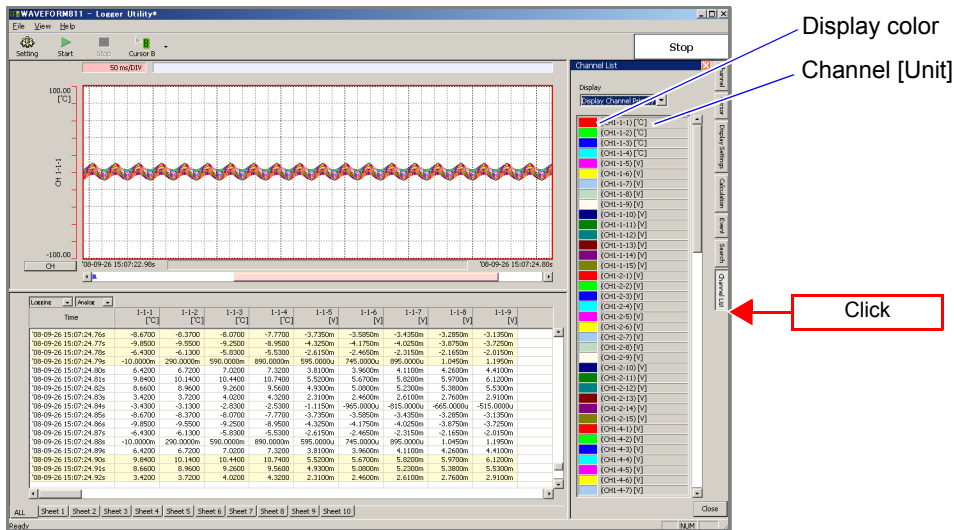

2. When you want to reduce the number of display channels, set the channels to display with the narrow down feature.

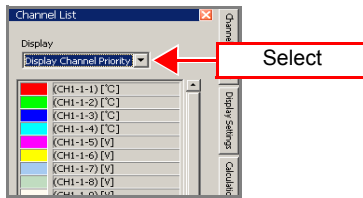

Selectable Items	Explanations
Display Channel Priority	Give priority to displaying the waveforms displayed in the current display sheet.
Display Channel Only	Display only the waveforms displayed in the current display sheet.
All Channels	Display all channels.

3. When other than the ALL sheet is selected, channel display can be set to OFF.

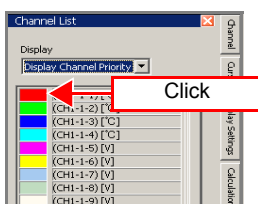

7.8 Confirming Measurement Conditions

Measurement conditions such as the start time, number of measurement data items, and memory usage status are displayed in real time. The [Measurement Conditions] tab is only displayed during measurement.

1. Click the [Measurement Conditions] tab on the right side of the main screen to open the display window.

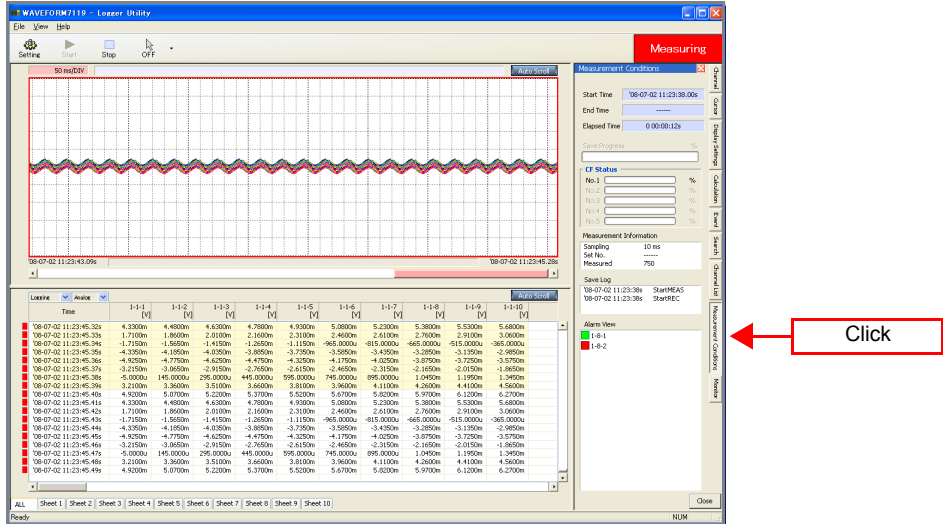

2. Confirm various measurement conditions.

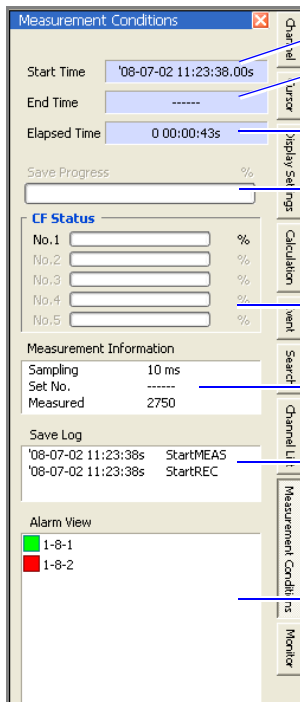

- Measurement start time
- Scheduled measurement end time (This is not displayed when waiting for a trigger, when external sampling, and when continuous recording.)
- Elapsed time
- The progress rate for saving data is indicated by a numerical value and bar.
- Calculation formula for progress rate $\frac{\text{Number of measurement data items}}{\text{Number of setting data items}} \times 100 [\%]$
- The CF card usage status is displayed in real time for each logger. (Up to 5 loggers)
- This area displays the sampling, number of setting data items, and number of measurement data items.
- This area displays the save status since the start of measurement.
- This area displays the alarm output status in real time.
- This area displays the warning status since the start of measurement.
- Red: Alarm activated
- Green: Alarm not activated

7.9 Monitor Display

Instantaneous values of each channel are displayed in real time as digital values. The [Monitor] tab is only displayed during measurement.

1. Click the [Monitor] tab on the right side of the main screen to open the display window.

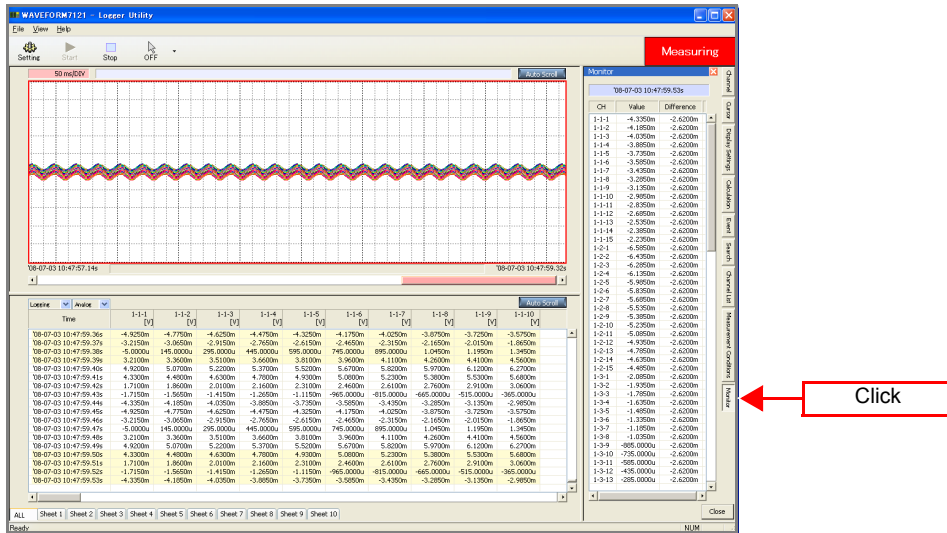

2. Confirm the instantaneous values of each channel.

This indicates the channel number.

This indicates the current measurement values. The values are updated as needed at the set update time. When the display is logic, "1" is displayed when in the HIGH state, and "0" when in the LOW state.

This indicates the differences between the current measurement values and those of the sampling immediately before.

CH	Value	Difference
1-1-1	-5.0000u	3.2100m
1-1-2	145.0000u	3.2100m
1-1-3	295.0000u	3.2100m
1-1-4	445.0000u	3.2100m
1-1-5	595.0000u	3.2100m
1-1-6	745.0000u	3.2100m
1-1-7	895.0000u	3.2100m
1-1-8	1.0450m	3.2100m
1-1-9	1.1950m	3.2100m
1-1-10	1.3450m	3.2100m
1-1-11	1.4950m	3.2100m
1-1-12	1.6450m	3.2100m
1-1-13	1.7950m	3.2100m
1-1-14	1.9450m	3.2100m
1-1-15	2.0950m	3.2100m

If there is no data for the low-speed unit at the latest position during dual sampling, the last measured data is displayed. In such a case, the character background is gray.

Saving and Reading Data

Chapter 8

You can save and read the data you measured and settings you configured with Logger Utility. The file types and extensions that can be handled are shown below.

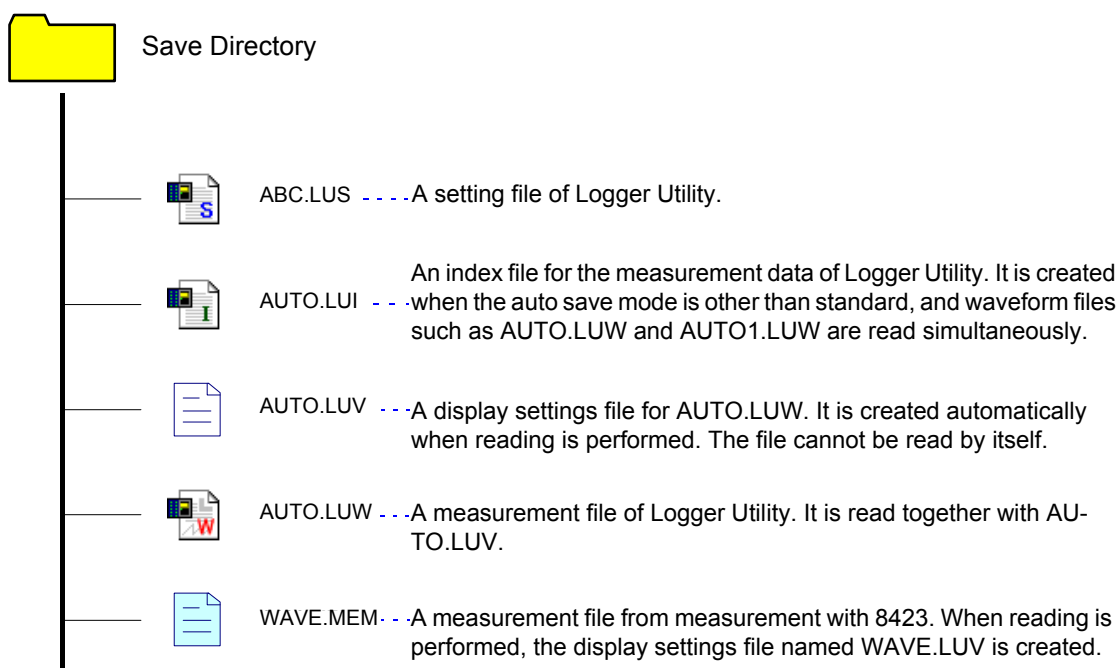

NOTE

- When a waveform file (.LUW, .MEM) or index file (.LUI) is read, the display settings file (.LUV) is also read together. If no display settings file exists, it is created automatically. Furthermore, when the application ends, the setting conditions are written automatically to the display settings file. However, when reading data saved to, for instance, a CD, the display conditions cannot be saved.
- When an index file (.LUI) is read, waveforms are not displayed if the waveform file (.LUW) from the time of measurement does not exist. When copying or moving files, be sure to copy or move both the index file and waveform file together.
- A display file (.LUV) cannot be read by itself.

8.1 Saving and Reading Measurement Data

8.1.1 Saving Measurement Data as Text

This section describes saving the measurement data obtained by Logger Utility in text format.

1. Click **[Save File in Text Format]** from the File menu to display the Save File in Text Format dialog box.
2. Select the target sheet for which to save measurement data. Click check boxes to select the channels to be saved.

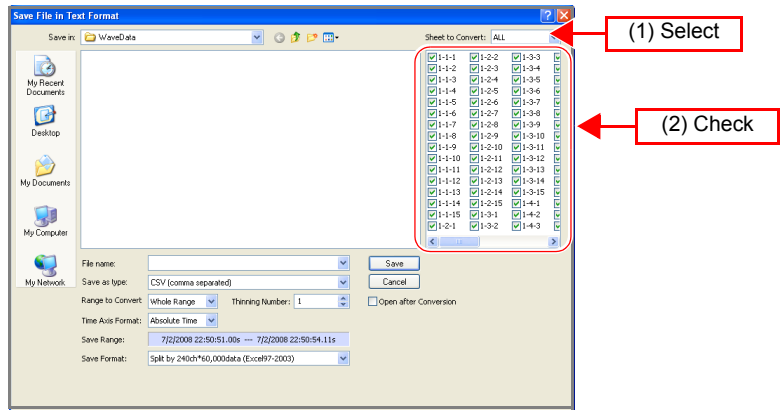

3. Enter a file name, and select the save format with **[Save as type]**.

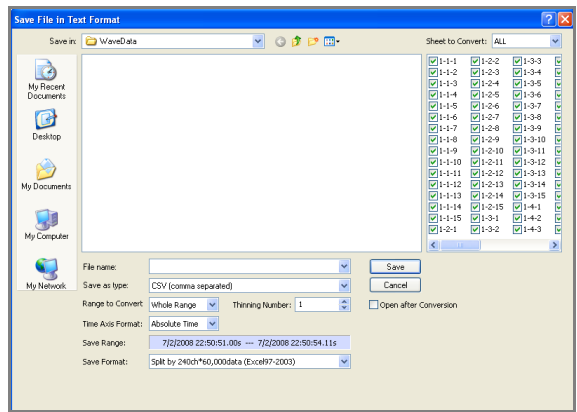

File Type	Extension
CSV (Comma separated)	.CSV
Text (Space separated)	.TXT
Text (Tab separated)	.TXT

4. Specify the range for saving data with [Range to Convert].

Selectable Items	Explanations
Whole Range	Save waveform data for the whole range.
Between A-B	Save waveform data for the section between cursor A and cursor B. If there is only one cursor, the data from the cursor position to the end is saved.

5. Enter a value for [Thinning Number] by clicking the spin buttons.
If the value for the thinning number is 1, all data is saved. In other cases, data is thinned at the specified interval and then saved.

6. Select the desired item from the list for [Time Axis Format].

Selectable Items	Explanations
Absolute Time	Save time data with the absolute time measurement started set as the reference.
Relative Time	Save time data with the time measurement started set to 0.
Second	Save time data with the time measurement started set to 0 and indicated in seconds.
Point	Save time data with the time measurement started set to 0 and as the number of data points.

7. Select the desired item form the list for [Save Format].

Selectable Items	Explanations
Split by 240ch*60,000data (Excel97-2003)	Measurement data is divided with 240 channels * 60,000samples.
Split by 600ch*1,000,000data (Excel2007)	Measurement data is divided with 600 channels * 1,000,000samples.
No split	Measurement data is saved at one file.
CH-info. is arranged to a data part (Excel97-2003)	The channel information is appended to data header and measurement data is divided with 240 channels * 60,000samples.
CH-info. is arranged to a data part (Excel2007)	The channel information is appended to data header and measurement data is divided with 600 channels * 1,000,000samples.
CH-info. is arranged to a data part (no split)	The channel information is appended to data header and m Measurement data is saved at one file.

8. Click the [Save] button.

NOTE

A file saved in text format cannot be read with Logger Utility.

Internal Format of CSV Format File and Text Format File

A CSV format file and text format file consist of a header section and a data section. The header section contains the following information regarding measurement channels. (The file in the figure is a CSV format file.)

Header section		Measurement mode	Measurement range	Comment	Screen information						
File name											
test1.CSV		Page 1 / 2									
Trigger Time '07-07-03 15:00:01 s											
Ch	Mode	Range	Comment	Scaling	Ratio	Offset					
CHI-2-1	Thermocouple	100 ° C f.s.		OFF	-	-					
CHI-2-2	Voltage	1 V f.s.		OFF	-	-					
CHI-2-3	Voltage	1 V f.s.		OFF	-	-					
CHI-2-4	Voltage	1 V f.s.		OFF	-	-					
CHI-2-5	Voltage	1 V f.s.		OFF	-	-					
CHI-2-6	Voltage	1 V f.s.		OFF	-	-					
CHI-2-7	Voltage	1 V f.s.		OFF	-	-					
CHI-2-8	Voltage	1 V f.s.		OFF	-	-					
CHI-2-9	Voltage	1 V f.s.		OFF	-	-					
CHI-2-10	Voltage	1 V f.s.		OFF	-	-					
CHI-2-11	Voltage	1 V f.s.		OFF	-	-					
CHI-2-12	Voltage	1 V f.s.		OFF	-	-					
CHI-2-13	Voltage	1 V f.s.		OFF	-	-					
CHI-2-14	Voltage	1 V f.s.		OFF	-	-					
CHI-2-15	Voltage	1 V f.s.		OFF	-	-					
Time	CHI-2-1 [° C]	CHI-2-2[V]	CHI-2-3[V]	CHI-2-4[V]	CHI-2-5[V]	CHI-2-6[V]	CHI-2-7[V]	CHI-2-8[V]	CHI-2-9[V]		
'07-07-03 15:00:01.00s	2.86E+01	-4.93E-01	-4.95E-01	-4.96E-01	-4.97E-01	-4.99E-01	-5.00E-01	-5.01E-01	-5.02E-01		
'07-07-03 15:00:01.01s	2.86E+01	-4.57E-01	-4.59E-01	-4.62E-01	-4.64E-01	-4.66E-01	-4.68E-01	-4.70E-01	-4.72E-01		
'07-07-03 15:00:01.02s	2.86E+01	-4.30E-01	-4.30E-01	-4.31E-01	-4.31E-01	-4.31E-01	-4.31E-01	-4.31E-01	-4.31E-01		
'07-07-03 15:00:01.03s	2.86E+01	-4.14E-01	-4.16E-01	-4.17E-01	-4.18E-01	-4.19E-01	-4.20E-01	-4.21E-01	-4.22E-01		
'07-07-03 15:00:01.04s	2.86E+01	-3.79E-01	-3.81E-01	-3.83E-01	-3.85E-01	-3.87E-01	-3.89E-01	-3.91E-01	-3.93E-01		
'07-07-03 15:00:01.05s	2.86E+01	-3.44E-01	-3.44E-01	-3.45E-01	-3.45E-01	-3.45E-01	-3.45E-01	-3.45E-01	-3.45E-01		
'07-07-03 15:00:01.06s	2.86E+01	-3.31E-01	-3.32E-01	-3.33E-01	-3.35E-01	-3.36E-01	-3.36E-01	-3.37E-01	-3.38E-01		
'07-07-03 15:00:01.07s	2.86E+01	-2.97E-01	-2.99E-01	-3.01E-01	-3.03E-01	-3.05E-01	-3.07E-01	-3.08E-01	-3.10E-01		
'07-07-03 15:00:01.08s	2.87E+01	-2.56E-01	-2.56E-01	-2.56E-01	-2.55E-01	-2.56E-01	-2.57E-01	-2.60E-01	-2.63E-01		
'07-07-03 15:00:01.09s	2.86E+01	-2.45E-01	-2.45E-01	-2.46E-01	-2.47E-01	-2.48E-01	-2.49E-01	-2.50E-01	-2.51E-01		
'07-07-03 15:00:01.10s	2.89E+01	-2.13E-01	-2.15E-01	-2.17E-01	-2.19E-01	-2.21E-01	-2.23E-01	-2.25E-01	-2.26E-01		
'07-07-03 15:00:01.11s	2.88E+01	-1.65E-01	-1.66E-01	-1.68E-01	-1.71E-01	-1.74E-01	-1.76E-01	-1.79E-01	-1.82E-01		
'07-07-03 15:00:01.12s	2.87E+01	-1.57E-01	-1.58E-01	-1.58E-01	-1.59E-01	-1.60E-01	-1.60E-01	-1.61E-01	-1.61E-01		
'07-07-03 15:00:01.13s	2.89E+01	-1.28E-01	-1.30E-01	-1.32E-01	-1.33E-01	-1.35E-01	-1.37E-01	-1.39E-01	-1.40E-01		
'07-07-03 15:00:01.14s	2.88E+01	-7.82E-02	-8.09E-02	-8.37E-02	-8.65E-02	-8.94E-02	-9.20E-02	-9.45E-02	-9.71E-02		
'07-07-03 15:00:01.15s	2.89E+01	-6.71E-02	-6.78E-02	-6.86E-02	-6.94E-02	-7.00E-02	-7.06E-02	-7.11E-02	-7.13E-02		
'07-07-03 15:00:01.16s	2.89E+01	-4.26E-02	-4.43E-02	-4.61E-02	-4.78E-02	-4.93E-02	-5.07E-02	-5.19E-02	-5.32E-02		

Data section

8.1.2 Converting Measurement Data to an Excel File

This section describes outputting the measurement data obtained by Logger Utility to Excel.

1. Click **[Output Data to Excel]** from the File menu to display the Microsoft Excel dialog box.
2. Select the target sheet for which convert measurement data. Click check boxes to select the channels to be converted.

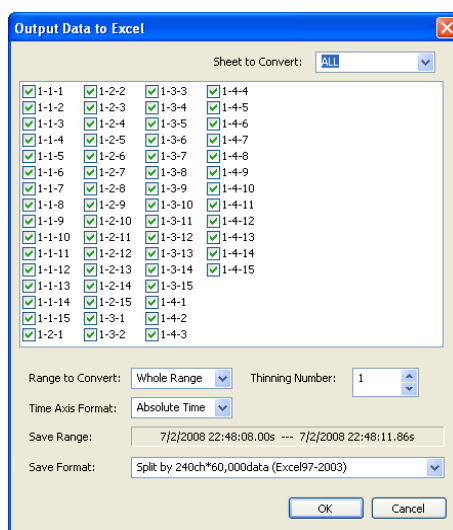

3. Specify the range for converting data with **[Range to Convert]**.

Selectable Items	Explanations
Whole Range	Convert waveform data for whole range.
Between A-B	Convert waveform data for the section between cursor A and cursor B. If there is only on cursor, the data from the cursor position to the end is converted.

NOTE

Excel might cause an out of memory error when there are a lot of cells. In this case, please narrow the range to convert by A-B cursor.

4. Enter a value for **[Thinning Number]** by clicking the spin button. If the value for the thinning number is 1, all data is converted. In other cases, data is thinned at the specified interval and then converted.

8.1 Saving and Reading Measurement Data

5. Select the desired item from the list for [Time Axis Format].

Selectable Items	Explanations
Absolute Time	Convert time data with the absolute time measurement started set as the reference.
Relative Time	Convert time data with the time measurement started set to 0.
Second	Convert time data with the time measurement started set to 0 and indicated in seconds.
Point	Convert time data with the time measurement started set to 0 and as the number of data points.

6. Select the desired item from the list for [Save Format] since a line limit changes by version of Excel.

Selectable Items	Explanations
Split by 240ch*60,000 data (Excel97-2003)	Measurement data is divided with 240 channels * 60,000samples.
Split by 600ch*1,000,000 data (Excel2007)	Measurement data is divided with 600 channels * 1,000,000samples.

7. Click [OK] and then a conversion is started. If you need to save the data, save the data on excel.

Example of saving as an Excel file:

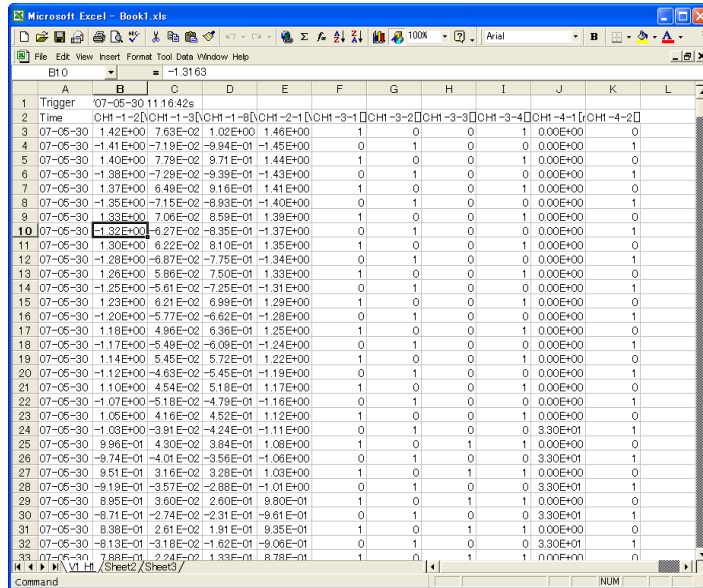

8.1.3 Reading Measurement Data

This section describes reading the files of waveforms measured in Logger Utility (Extension: .LUW), index files (Extension: .LUI), and data of waveforms measured with the instrument (Extension: .MEM).

1. Click **[Open Waveform File]** from the File menu to display the Open Waveform File dialog box.
2. Select the file to read, and click the **[Open]** button.

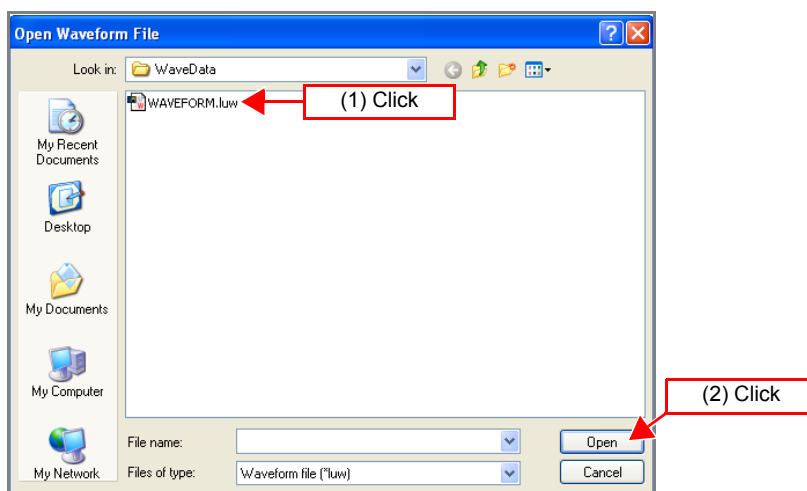

NOTE

If measurement data is saved to a CF card while measurement is being performed with Logger Utility, the following phenomena may occur if the clock of the instrument and the clock of the computer differ at the time of measurement.

- The times for the initial data in the files of Logger Utility and the instrument will be different, even though they are for the same measurements.
- When files are split at regular intervals in auto save mode, the files will not be split at the exact times.
- When synchronized measurement is performed and data is saved by splitting files at regular intervals in auto save mode, the split position in each of the instruments will differ.

8.2 Saving and Reading Setting Data

You can save the settings configured with Logger Utility and the display settings. It is also possible to read set data. (Extension: .LUS)

NOTE

Measurement waveforms are not included in setting data.

8.2.1 Saving Setting Data

1. Click **[Save Setting File]** from the File menu to display the Save Setting File dialog box.
2. Specify the location to save the file and enter a file name.
3. Click the **[Save]** button.

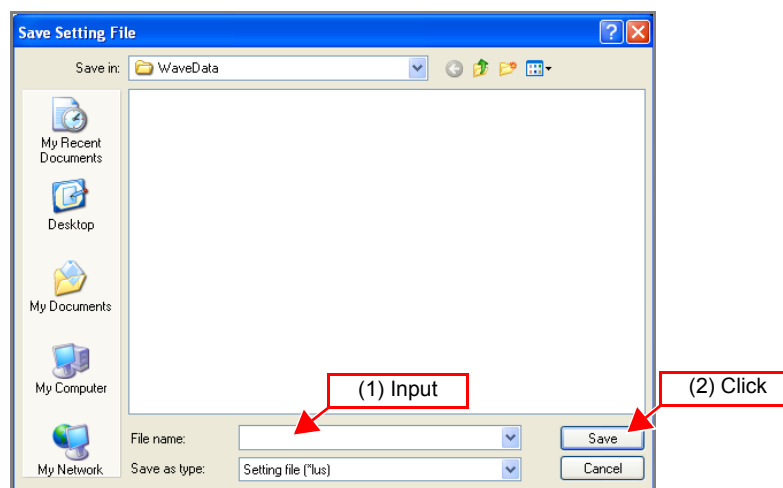

8.2.2 Reading Setting Data

1. Click **[Open Setting File]** from the File menu to display the Open Setting File dialog box.
2. Select the file to read, and click the **[Open]** button.

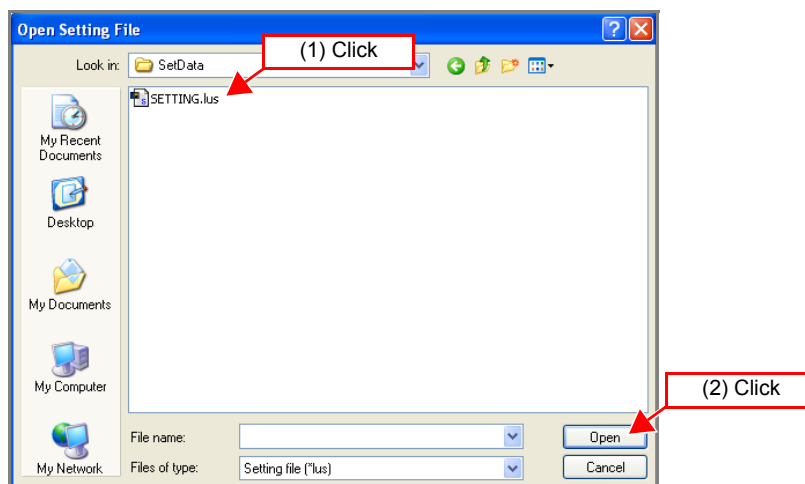

8.3 Automatically Transferring Measurement Data to Excel

While measuring with the Logger Utility, data can be automatically transferred to Excel in real time.

8.3.1 Real-Time Transfer Settings

1. In the menu bar, select **[File]-[Transfer real time data to Excel...]**. The **[Real time data transfer to Excel]** dialog appears.
2. Select **[Transfer real time data to Excel]**.
3. Select which channels' data to transfer to Excel.
4. Enter the first cell for data transfer to Excel.
Data is transferred to Excel starting with the cell entered here. Enter a valid Excel cell number, from **[A1]** to **[IV65000]**.
5. Enter the maximum number of data values to be transferred to Excel.
6. Select the time axis label type from the list.

Selectable Items	Explanations
Absolute Time	Display absolute time from the start of measurement.
Relative Time	Display relative time from zero at the start of measurement.
Second	Display relative time in seconds from zero at the start of measurement.
Point	Display relative time as the number of data points from zero at the start of measurement.

7. To repeat data transfer from the line specified in Step 4 after the amount of data specified in Step 5 has been transferred to Excel
8. Click **[OK]**.

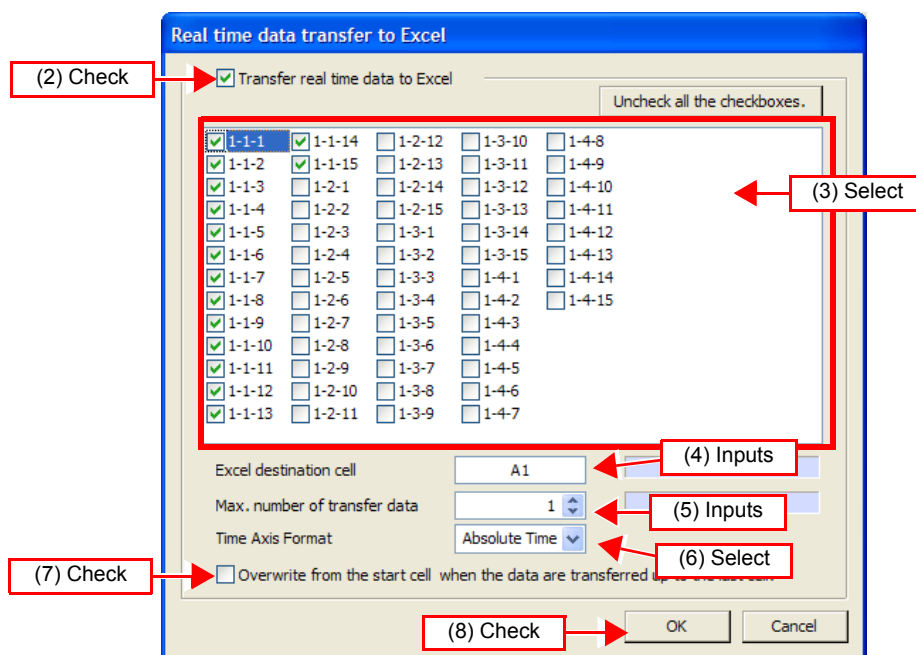

8.3 Automatically Transferring Measurement Data to Excel

NOTE

- Real-time data transfer is not possible when more than 120 channels are selected. Select no more than 120 channels.
- During real-time data transfer, Logger Utility waveform calculations (Z1 to Z60) cannot be changed.
- Attempting to use Excel during real-time data transfer may interfere with the transfer and result in loss of measurement data. Avoid using Excel during data transfer.
- If a sheet having the same name as the file specified for saving Logger Utility measurements is already open in Excel, data is transferred into that sheet. If such a sheet is not already open, one is created with the specified save file name (but without appended serial number).
- If multiple sheets are open with the same file name, data will be transferred into any sheet.
- The destination cell contents are cleared when transfer starts, and the cell format and display width are adjusted.
- When "Overwrite from the start cell..." is selected, and a data transfer is delayed for more than one cycle, data acquired during the delay may be lost.
- Data transfer typically refreshes about once per second, but may be slower if the Logger Utility and Excel processes are heavily loaded.
- When attempting to transfer data for many channels and lines, Excel may exhaust available memory. In that case, reduce the amount of data to be transferred.

8.3.2 Real-Time Transfer Example

	A	B	C	D	E	F	G
1		CH1-1-1[V]	CH1-1-2[V]	CH1-1-3[V]	CH1-1-4[V]	CH1-1-5[V]	
2	4/19/2010 13:11:14.00s	0.0000E+00	1.5000E-04	3.0000E-04	4.5000E-04	6.0000E-04	
3	4/19/2010 13:11:14.01s	3.2100E-03	3.3600E-03	3.5100E-03	3.6600E-03	3.8100E-03	
4	4/19/2010 13:11:14.02s	4.9200E-03	5.0700E-03	5.2200E-03	5.3700E-03	5.5200E-03	
5	4/19/2010 13:11:14.03s	4.3300E-03	4.4800E-03	4.6300E-03	4.7800E-03	4.9300E-03	
6	4/19/2010 13:11:14.04s	1.7100E-03	1.8600E-03	2.0100E-03	2.1600E-03	2.3100E-03	
7	4/19/2010 13:11:14.05s	-1.7150E-03	-1.5650E-03	-1.4150E-03	-1.2650E-03	-1.1150E-03	
8	4/19/2010 13:11:14.06s	-4.3350E-03	-4.1850E-03	-4.0350E-03	-3.8850E-03	-3.7350E-03	
9	4/19/2010 13:11:14.07s	-4.9250E-03	-4.7750E-03	-4.6250E-03	-4.4750E-03	-4.3250E-03	
10	4/19/2010 13:11:14.08s	-3.2150E-03	-3.0650E-03	-2.9150E-03	-2.7650E-03	-2.6150E-03	
11	4/19/2010 13:11:14.09s	0.0000E+00	1.5000E-04	3.0000E-04	4.5000E-04	6.0000E-04	
12							
13							
14							
15							

8.4 Notes in Windows Vista /7

- The setting file and waveform file that Logger Utility made are preserved in a special folder in each user by user account control function (UAC) is added by Windows Vista /7. Therefore, another user cannot be shared with the file and waveform file.
- Waveform files is saved in C:\Program Files\HIOKI\Logger Utility\WaveData if Logger Utility is installed by default settings. But waveform files are not displayed even if this folder is opened by Explorer. It is displayed by clicking the **[Compatibility Files]** displayed on a tool bar.

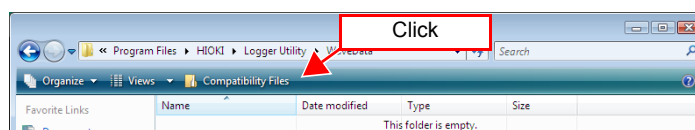

Printing

Chapter 9

Measurement data collected in the "Logger Utility" (extension: .LUW) or index file (extension: .LUI) as well as measurement data (extension: .MEM) saved in the CF card of the Memory Hi-Logger can be printed.

Carry out the various settings in the **[Print Active Sheet]** dialog before printing. The **[Print Active Sheet]** dialog can be displayed by clicking **[File]-[Print]** on the menu bar.

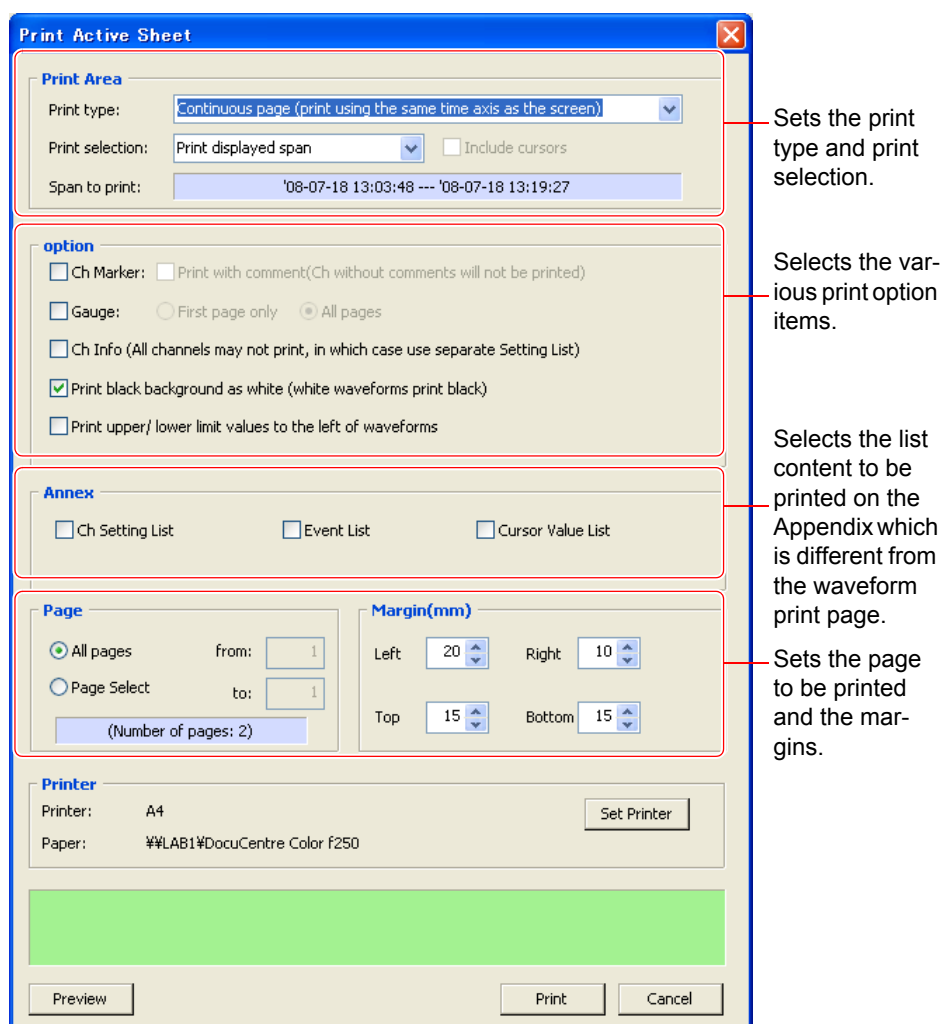

NOTE

Only the waveforms on the currently displayed sheet will be printed. To print waveforms of other sheets, display the waveforms of the sheets beforehand.

9.1 Setting the Printing Range

To set the print format and printing range of the displayed waveforms.

1. Click **[File]-[Print]** on the menu bar to display the **[Print Active Sheet]** dialog.
2. Set **[Print type]** and **[Print selection]**.

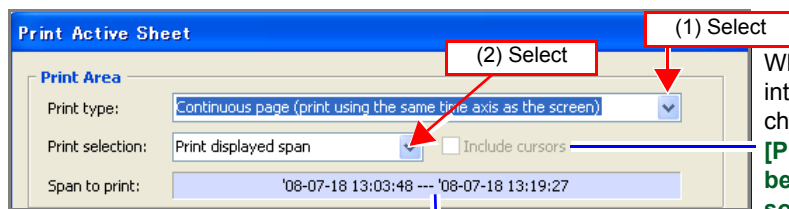

Printing range will be displayed in accordance with the selected print format and print interval.

When the print interval is checked as **[Print the span between cursors]**, print intervals are widened and the A/B cursors are printed.

Print type:

Selectable Items	Explanations
Print no waveforms	Waveform will not be printed.
Continuous Page (Print using the same time axis as the screen)	Print the waveform continuously across several pages.
Print the selection on one page	Compress the waveform in the selected print interval onto 1 page for printing.
Displayed screen	Print the waveform screen on display.
Print report	Print the report. When printing the report, waveform screen, and setting lists for the various channels will be printed.
Specified interval: 1 hour/page [hourly, on the hour]	Print the printing range of one page on an hourly basis. Each interval period starts [hourly, on the hour] . At the same time, the maximum, minimum and average values of the various channels in the printing range are also printed.
Specified interval: 1 day/page [00:00-24:00]	Print the printing range of one page on a daily basis. One interval period is [00:00-24:00] . At the same time, the maximum, minimum and average values of the various channels in the printing range are also printed.
Specified interval: 1 week/page [Sun.-Sat.]	Print the printing range of one page on a weekly basis. One interval period is [Sun.-Sat.] . At the same time, the maximum, minimum and average values of the various channels in the printing range are also printed.
Specified interval: 1 month/page [1st-31st day]	Print the printing range of one page on a monthly basis. One interval period is [1st-31st day] . At the same time, the maximum, minimum and average values of the various channels in the printing range are also printed.

Print selection:

Not applicable when **[Print type]** is selected as **[Displayed Screen]**.

Selectable Items	Explanations
Print whole span	Print waveforms of all ranges.
Print displayed span	Print waveform in the range shown.
Print the span between cursors	Print waveforms between cursors A and B (available when the A/B cursors are displayed in the waveform display screen).

NOTE

When the **[Print selection]** is selected as **[Print the span between cursors]** and only one cursor is displayed, the interval between the position of the displayed cursor and the end of the waveform will be printed.

9.2 Settings for Waveform Print Options

To select the various waveform print options. To select, click the check box to insert a check mark.

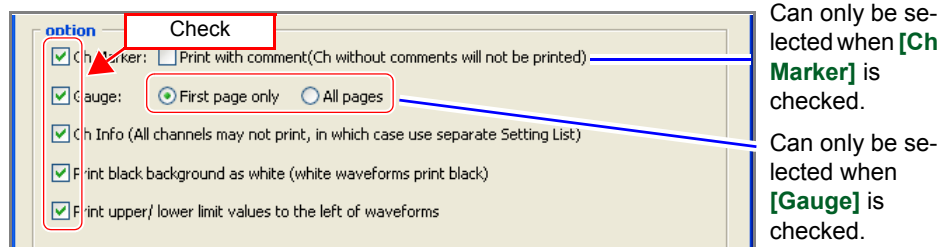

Ch Marker:

Prints CH number near the waveform as a CH marker.

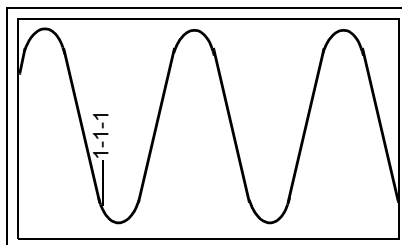

Print with comment:

Prints comment near the waveform as a Ch marker.

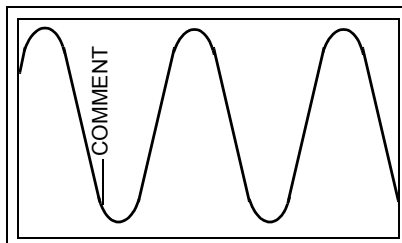

Gauge:

Prints the gauge (graduations) in the left side of the waveform print area. The number of gauges that will be printed is the same as the number of gauges displayed in the waveform display portion.

Selectable Items	Explanations
First page only	Print gauge in the first page only.
All pages	Print gauge in all pages.

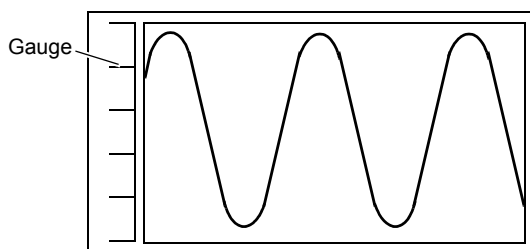

9.2 Settings for Waveform Print Options

Ch info:

Prints the information of various channels in the waveform print area. (Not applicable when **[Print type]** is set as **[Print report]** or **[Specified interval]**)

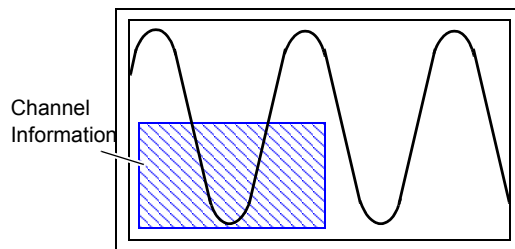

- When **[Print upper/lower limit values to the left of waveforms]** is checked: Channel number, waveform display color, unit type, input type, range, display/DIV, filter setting, and comment will be printed.
- When **[Print upper/lower limit values to the left of waveforms]** is not checked: Channel number, waveform display color, range, upper/lower limit values, filter setting, and comment will be printed.

Print black background as white:

Whitens the background for printing when the background of the waveform display portion is black. Waveforms that are white will be printed in black.

Print upper/lower limit values to the left of waveforms:

Prints the upper limit value at the top left side and the lower limit value at the bottom left side of the waveform print area.

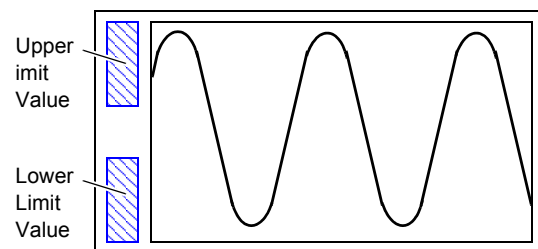

NOTE

- When **[Print with comment]** is checked, the Ch marker for channels without any comment input will not be printed. Be sure to click on the **[Channel]** tab found on the right side of the screen and input comments within the setting window beforehand (p. 140).
- When gauge is not displayed in the waveform display portion, gauge will not be displayed even if **[Gauge]** is checked. Make sure that gauge is displayed beforehand (p. 145).
- When number of channel is many, the printer may not be able to print channel information for all channels, and upper and lower limit values if there are too many channels.

9.3 Settings for the Appendix

To select the list content to be printed on the Appendix.

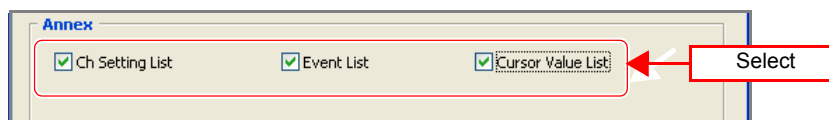

Ch Setting List:

Prints the list of Unit type, Channel number, Waveform display color, Range, Input type, Display/DIV, Filter settings, and Comments.

Event List:

Prints the list of Event Numbers, Event Positions, and Comments.

Cursor Value List:

Prints the list of Cursor A Measurement Values and Cursor B Measurement Values, Difference in measurement value between cursors A and B, Maximum value, minimum value, and average value between cursors A and B.

NOTE

- When the cursors A/B are not displayed in the waveform display portion, the Cursor Value List will not be printed. Make sure to display cursors A/B beforehand (p. 141).
- Only the cursor measurement value will be printed when there is only one cursor in the waveform display portion.

9.4 Printer Settings/Printing

Set the page(s) to be printed and the margin(s).

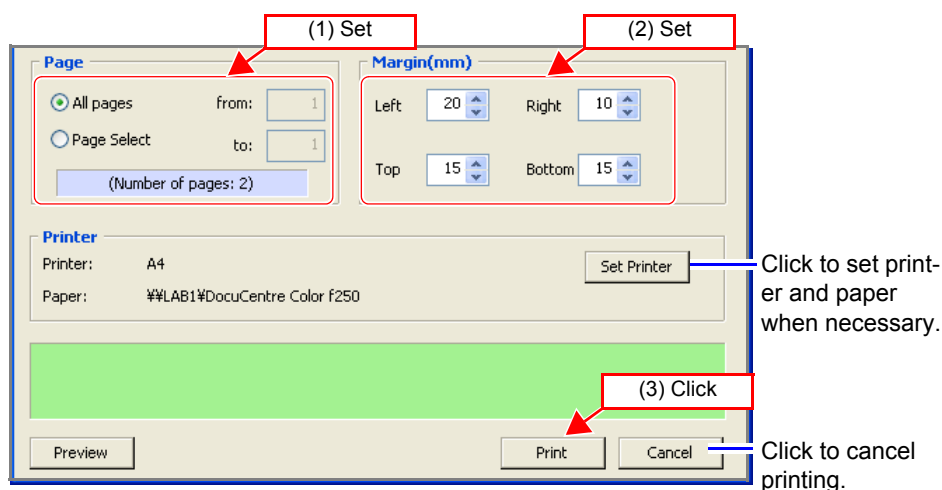

1. Set the page to be printed, and the upper, lower, left and right margins.
2. Click the **[Print]** button to start printing.

NOTE

Paper size and margin setting may lead to the instrument printing inaccurately.

9.5 Copy to Clipboard

To copy print images to the clipboard. Copied print images can be pasted on Word documents, etc.

1. Click the **[Preview]** button to display the **[Print Preview]** dialog.

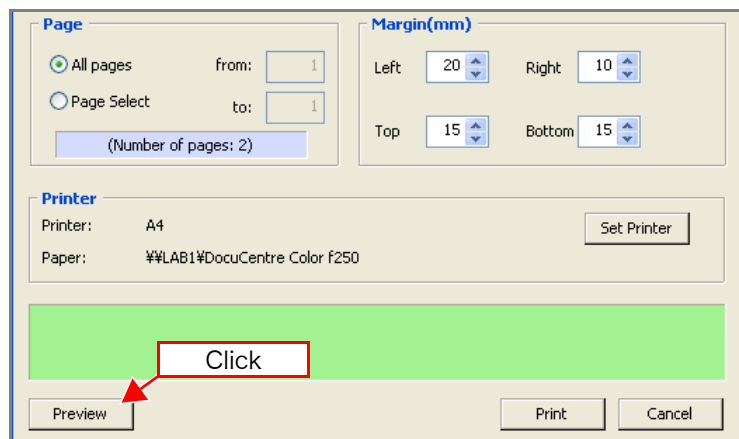

2. Click the **[To clipboard]** button to copy the print image displayed in the **[Print Preview]** dialog to the clipboard.

Show the page currently on display. Select the display zoom range. Start printing.

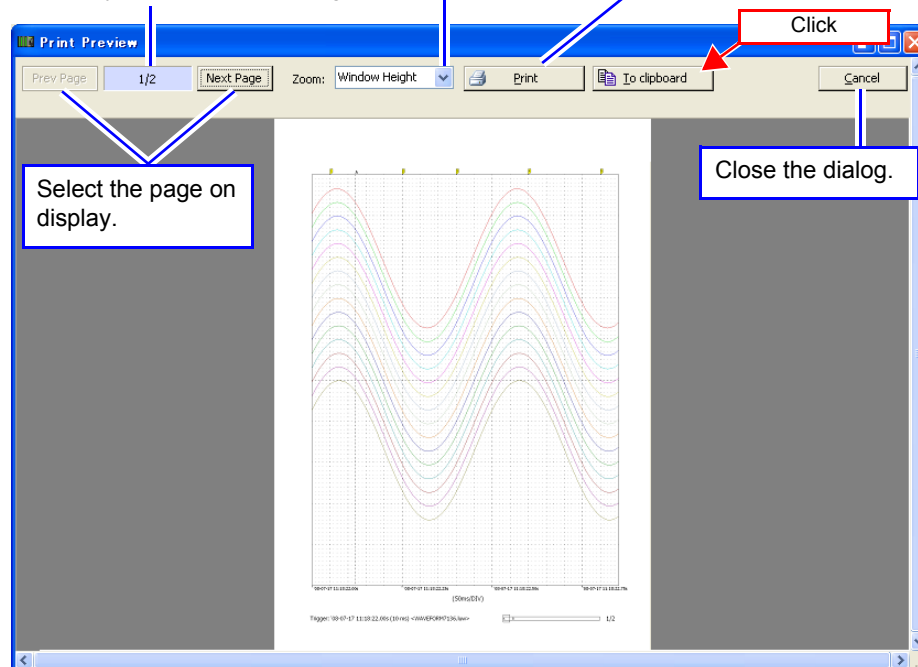

9.6 Print Example

Print Example 1: Print Continuous Pages (during selection of waveform printing option)

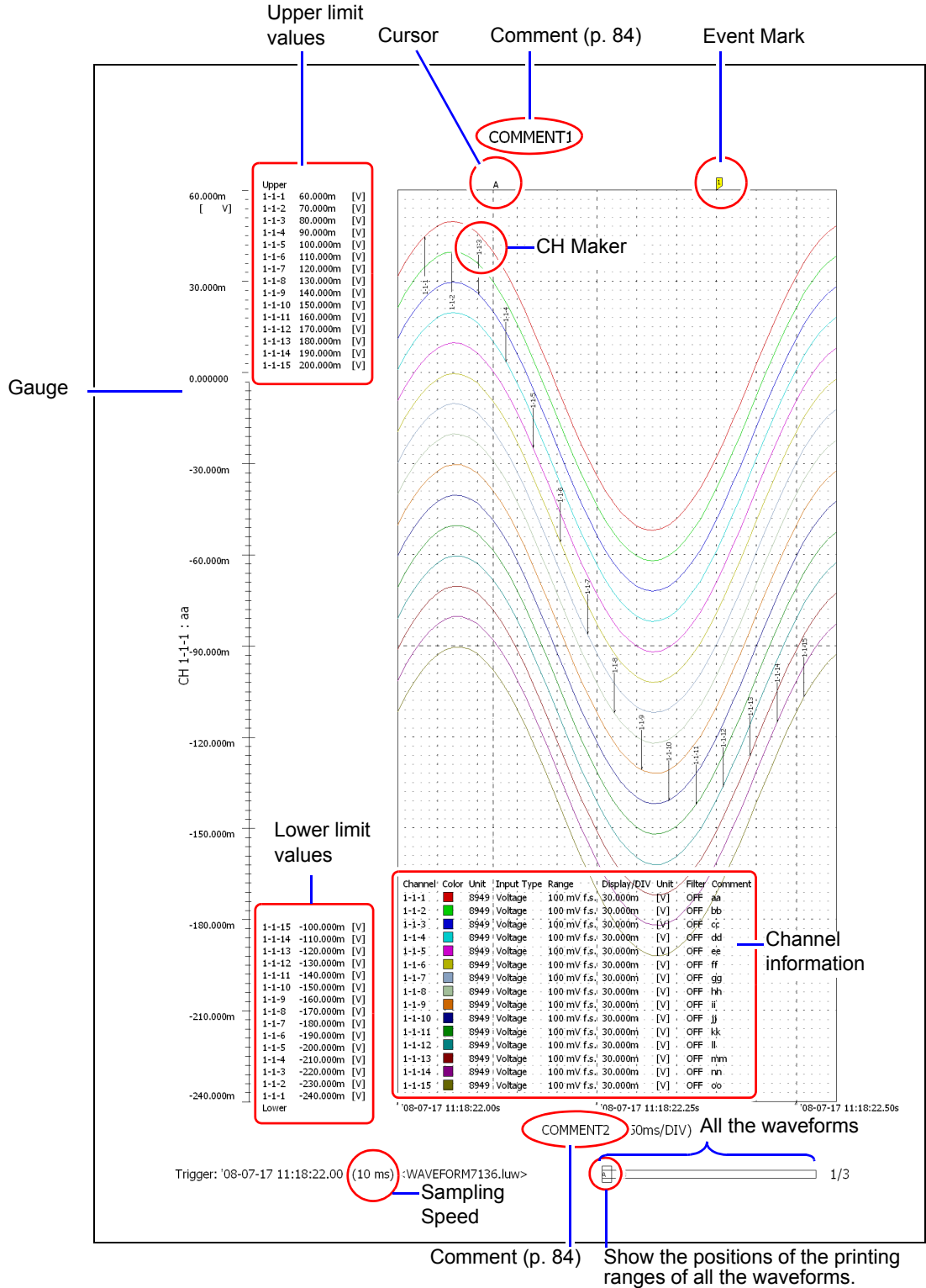

Print Example 2: Print Report

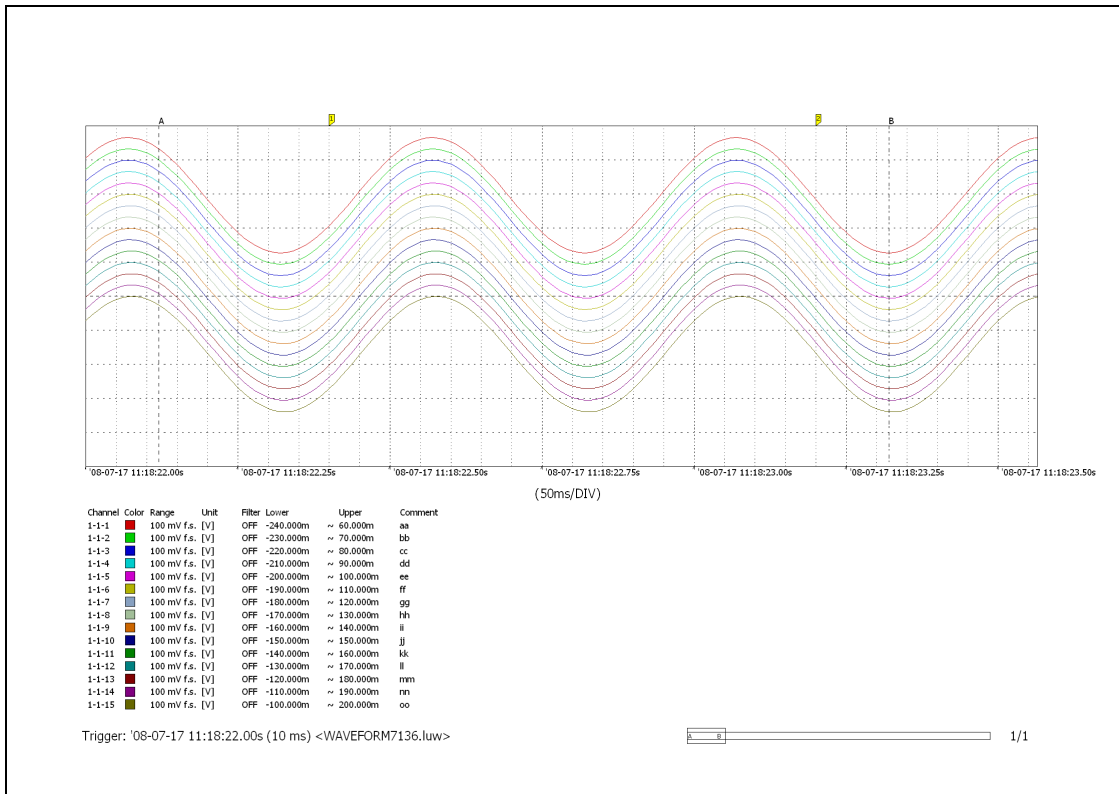

Print Example 3: Cursors A-B

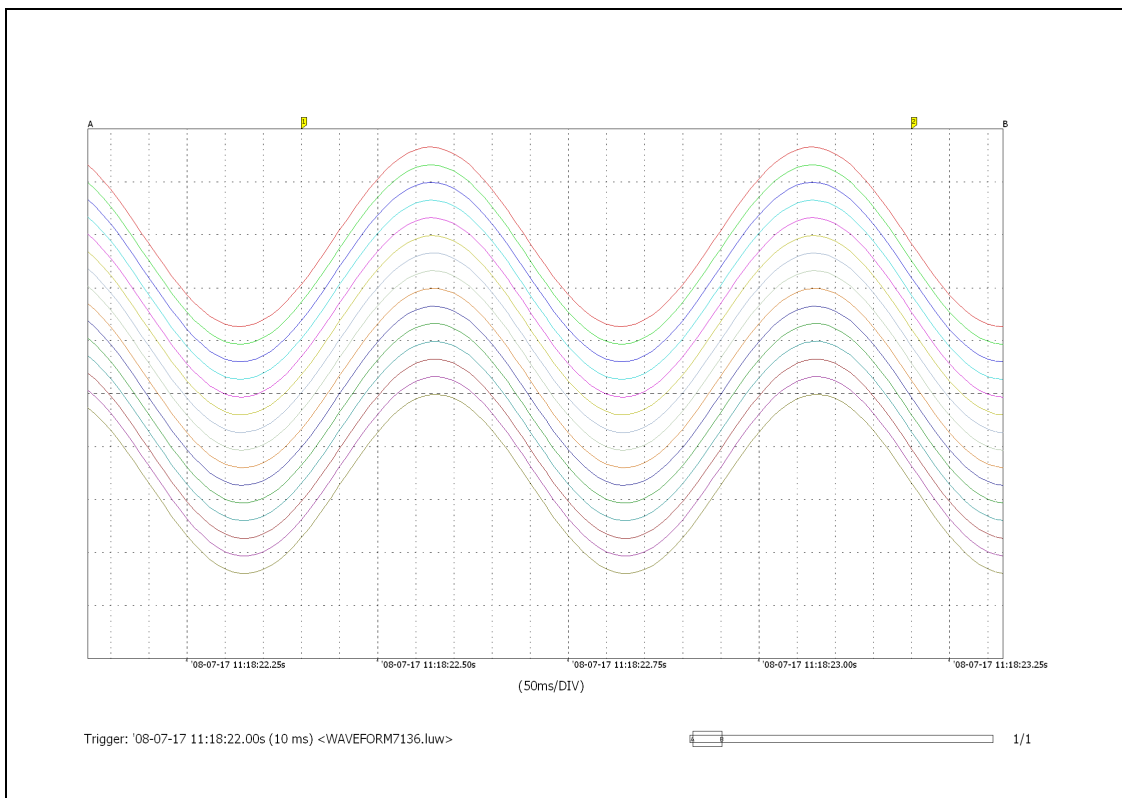

Print Example 4: Specified interval: 1 hour/page (When [option] gauge, upper and lower limit values are selected)

Example: Print waveforms measured from 13:03:48

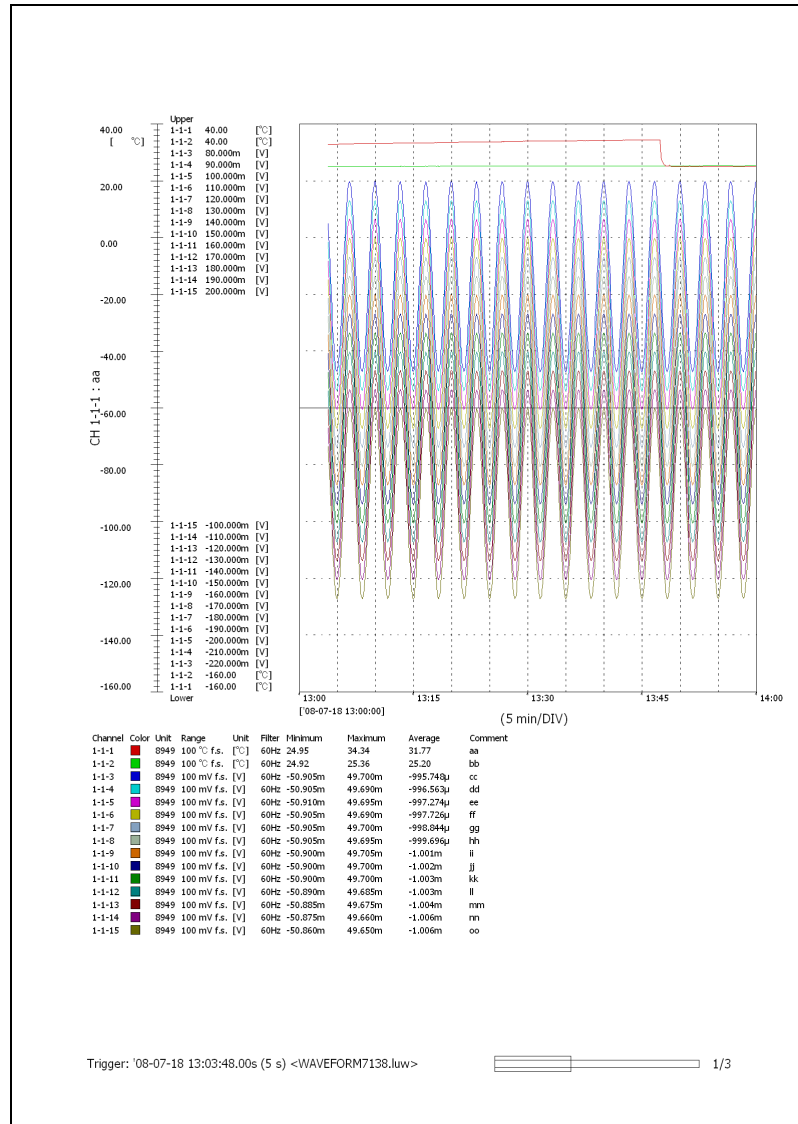

Page One (Print period: 13:00 to 14:00)
 Page Two (Print period: 14:00 to 15:00)

⋮

Print Example 5: Ch Setting List, Event List, Cursor Value List

Channel	Color	Unit	Input Type	Range	Display/DIV	Unit	Filter	Comment
1-1-1	■	8949	Voltage	100 mV f.s.	30.000m	[V]	OFF	aa
1-1-2	■	8949	Voltage	100 mV f.s.	30.000m	[V]	OFF	bb
1-1-3	■	8949	Voltage	100 mV f.s.	30.000m	[V]	OFF	cc
1-1-4	■	8949	Voltage	100 mV f.s.	30.000m	[V]	OFF	dd
1-1-5	■	8949	Voltage	100 mV f.s.	30.000m	[V]	OFF	ee
1-1-6	■	8949	Voltage	100 mV f.s.	30.000m	[V]	OFF	ff
1-1-7	■	8949	Voltage	100 mV f.s.	30.000m	[V]	OFF	gg
1-1-8	■	8949	Voltage	100 mV f.s.	30.000m	[V]	OFF	hh
1-1-9	■	8949	Voltage	100 mV f.s.	30.000m	[V]	OFF	ii
1-1-10	■	8949	Voltage	100 mV f.s.	30.000m	[V]	OFF	jj
1-1-11	■	8949	Voltage	100 mV f.s.	30.000m	[V]	OFF	kk
1-1-12	■	8949	Voltage	100 mV f.s.	30.000m	[V]	OFF	ll
1-1-13	■	8949	Voltage	100 mV f.s.	30.000m	[V]	OFF	mm
1-1-14	■	8949	Voltage	100 mV f.s.	30.000m	[V]	OFF	nn
1-1-15	■	8949	Voltage	100 mV f.s.	30.000m	[V]	OFF	oo

Ch Setting List

Event	Position	Comment
1	'08-07-17 11:18:22.05s	pp
2	'08-07-17 11:18:22.25s	qq
3	'08-07-17 11:18:22.40s	rr
4	'08-07-17 11:18:22.60s	ss
5	'08-07-17 11:18:22.80s	tt
6	'08-07-17 11:18:23.00s	uu
7	'08-07-17 11:18:23.20s	vv
8	'08-07-17 11:18:23.50s	ww

Event List

Channel	Unit	Cursor A	Cursor B	B-A	Minimum	Maximum	Average
1-1-1	[V]	39.640m	-52.000m	-91.640m	-52.005m	49.665m	-3.239m
1-1-2	[V]	39.845m	-52.000m	-91.845m	-52.005m	49.665m	-3.201m
1-1-3	[V]	39.970m	-52.000m	-91.970m	-52.010m	49.670m	-3.166m
1-1-4	[V]	40.155m	-52.000m	-92.155m	-52.010m	49.665m	-3.132m
1-1-5	[V]	40.355m	-52.010m	-92.365m	-52.010m	49.665m	-3.095m
1-1-6	[V]	40.540m	-52.000m	-92.540m	-52.005m	49.670m	-3.055m
1-1-7	[V]	40.750m	-52.000m	-92.750m	-52.010m	49.665m	-3.019m
1-1-8	[V]	40.840m	-52.000m	-92.840m	-52.005m	49.665m	-2.981m
1-1-9	[V]	41.035m	-52.000m	-93.035m	-52.010m	49.670m	-2.945m
1-1-10	[V]	41.230m	-51.965m	-93.195m	-51.965m	49.615m	-2.900m
1-1-11	[V]	41.430m	-51.905m	-93.335m	-51.920m	49.565m	-2.867m
1-1-12	[V]	41.550m	-51.915m	-93.465m	-51.920m	49.565m	-2.832m
1-1-13	[V]	41.735m	-51.910m	-93.645m	-51.915m	49.565m	-2.788m
1-1-14	[V]	41.910m	-51.905m	-93.815m	-51.925m	49.570m	-2.749m
1-1-15	[V]	42.040m	-51.905m	-93.945m	-51.910m	49.575m	-2.707m

Cursor Value List

Setting Method for Logger

Chapter 10

You can switch the instrument to setting mode and perform the following tasks. Use the three keys on the front for operation.

Settable Items

- "10.2 Synchronized Measurement" (p. 187)
- "10.3 Date" (p. 188)
- "10.4 Time" (p. 189)
- "10.5 DHCP" (p. 190)
- "10.6 IP Address" (p. 191)
- "10.7 Subnet Mask" (p. 192)
- "10.8 Port Number" (p. 193)
- "10.9 Gateway" (p. 194)
- "10.10 Display Language" (p. 196)

START /MARK STOP DISP

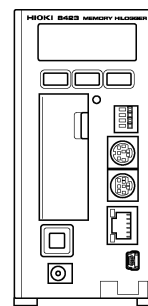

Self Check

- "10.11.1 ROM Check" (p. 197)
- "10.11.2 RAM Check" (p. 198)
- "10.11.3 BUS Check" (p. 199)
- "10.11.4 Key Check" (p. 200)
- "10.11.5 LED Check" (p. 201)
- "10.11.6 LCD Check" (p. 202)

Display of Individual Information

- "10.12.1 ROM Version" (p. 203)
- "10.12.2 FPGA Version" (p. 204)
- "10.12.3 MAC Address" (p. 205)
- "10.12.4 Serial No." (p. 206)

Setting Files

- "10.13.1 Writing a Setting File" (p. 207)
- "10.13.2 Reading a Setting File" (p. 208)

NOTE

Items other than the above (recording intervals, filter settings, measurement settings, trigger settings, etc.) cannot be set with the keys of the instrument. Connect a computer and use the supplied software Logger Utility to configure or change such settings.

10.1 Setting Method

Enter setting mode on the instrument by turning the power on while pressing **DISP**, waiting for the model name and version to appear in the display area, and then releasing the key. Pressing **START/MARK** toggles the setting items as shown below.

Display Switching Order

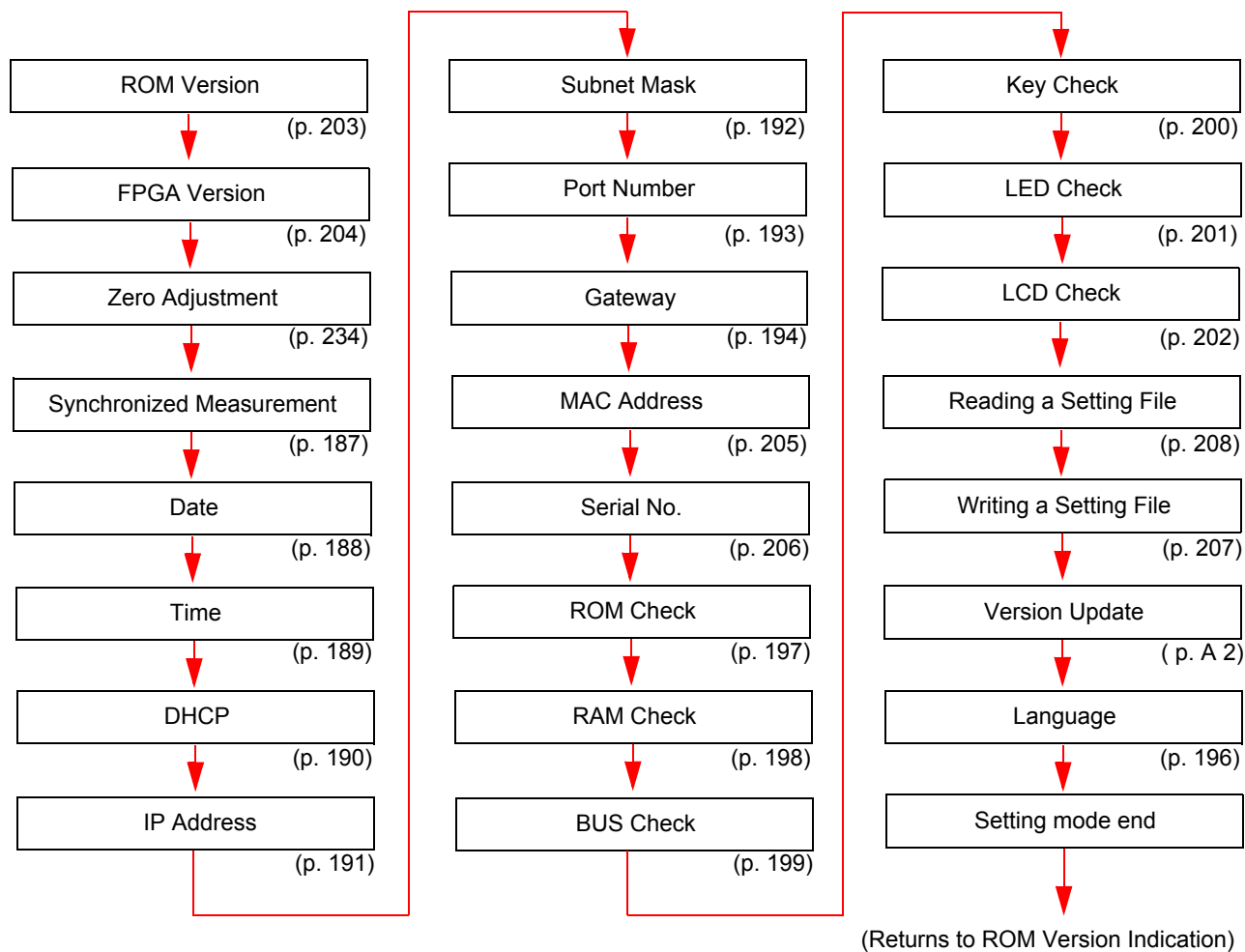

NOTE

Operations such as starting measurement are not possible while the instrument is in setting mode. Press **START/MARK** multiple times until the setting mode end screen appears, and then press **DISP** to end setting mode.

10.2 Synchronized Measurement

This section describes setting synchronized measurement to MASTER or SLAVE when you want to measure by synchronizing the sampling of multiple loggers.

1. Turn the power on while pressing

DISP and then release the key when the model name and version appear in the display area. The instrument enters setting mode.

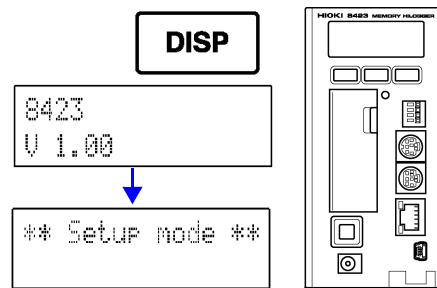

2. Press **START/MARK** multiple times until the following synchronized measurement setting screen appears.

```

SYNC :
MASTER SET
  
```

3. Press **DISP** to select the synchronization setting.

Each press of the key toggles the selection item.

Selectable Items	Explanations
MASTER	Set this instrument as the master and reference for sampling.
SLAVE	Set this instrument as the slave and match the reference for sampling to the master.
OFF	Do not set synchronized measurement.

4. Press **STOP** to move the flashing cursor to **[SET]**, and press **DISP** to confirm the setting.

```

SYNC :
MASTER SET
  
```

5. Press **START/MARK** multiple times until the following setting mode end screen appears.

```

Exit setup node
EXIT
  
```

6. Press **DISP** to end setting mode.

```

*Exit Set Mode *
  
```

NOTE

Multiple masters cannot be assigned to one measurement system.

10.3 Date

This section describes setting the data of the internal clock of the instrument.

1. Turn the power on while pressing **DISP** and then release the key when the model name and version appear in the display area. The instrument enters setting mode.

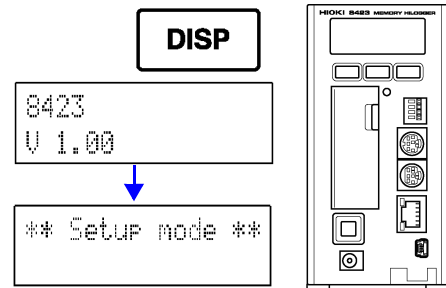

2. Press **START / MARK** multiple times until the following date setting screen appears.

```
DATA Setup Y-M-D
07-06-01 SET
```

3. Press **STOP** to move the flashing cursor to the position to change. Each press of the key moves the flashing cursor to the right.

4. Press **DISP** to increase the value at the flashing cursor in increments of 1. The value cannot be decremented.

5. Press **STOP** to move the flashing cursor to [SET], and press **DISP** to confirm the setting.

```
DATA Setup Y-M-D
07-06-01 SET
```

6. Press **START / MARK** multiple times until the following setting mode end screen appears.

```
Exit setup mode
EXIT
```

7. Press **DISP** to end setting mode.

```
*Exit Set Mode *
```

10.4 Time

This section describes setting the time of the internal clock of the instrument.

1. Turn the power on while pressing **DISP** and then release the key when the model name and version appear in the display area. The instrument enters setting mode.

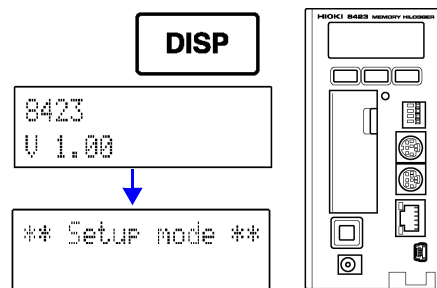

2. Press **START /MARK** multiple times until the following time setting screen appears.

```
TIME Setup H:M:S
14:10:00 SET
```

3. Press **STOP** to move the flashing cursor to the position to change. Each press of the key moves the flashing cursor to the right.

4. Press **DISP** to increase the value at the flashing cursor in increments of 1. The value cannot be decremented.

5. Press **STOP** to move the flashing cursor to [SET], and press **DISP** to confirm the setting.

```
TIME Setup H:M:S
14:10:00 SET
```

6. Press **START /MARK** multiple times until the following setting mode end screen appears.

```
Exit setup mode
EXIT
```

7. Press **DISP** to end setting mode.

```
*Exit Set Mode *
```

10.5 DHCP

This section describes setting DHCP for LAN communication to ON or OFF. See "LAN Connection Examples" (p. 71).

1. Turn the power on while pressing **DISP** and then release the key when the model name and version appear in the display area. The instrument enters setting mode.

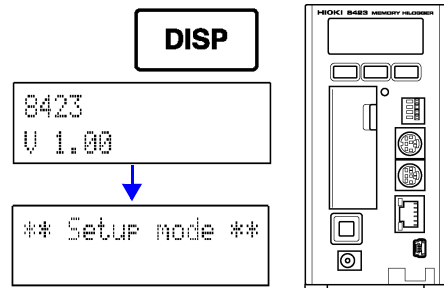

2. Press **START / MARK** multiple times until the following DHCP setting screen appears.

```
DHCP
OFF
```

3. Press **DISP** to select ON or OFF for DHCP. Each press of the key toggles the selection item.

4. Press **START / MARK** multiple times until the following setting mode end screen appears.

```
Exit setup mode
EXIT
```

5. Press **DISP** to end setting mode.

```
*Exit Set Mode *
```

DHCP is a function that enables an instrument to automatically obtain information such as its own IP address and configure the LAN settings accordingly. If DHCP is set to ON and a DHCP server is running within the same network, it is possible to automatically obtain the IP address, subnet mask, and gateway, and configure the settings.

If the DHCP server is not running, the default IP address is assigned. If DHCP is set to On and the IP address is not obtained from a DHCP server, it is automatically set to Off.

10.6 IP Address

This section describes setting the IP address of the instrument for LAN communication. See "LAN Connection Examples" (p. 71).

1. Turn the power on while pressing **DISP** and then release the key when the model name and version appear in the display area. The instrument enters setting mode.

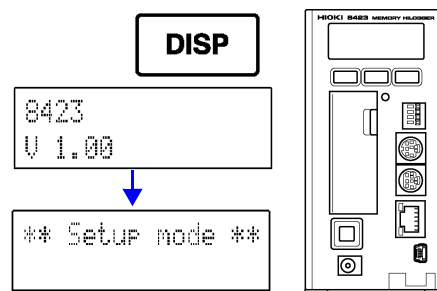

2. Press **START/MARK** multiple times until the following IP address setting screen appears.

```
IP Address  SET
192:168:001:002
```

3. Press **STOP** to move the flashing cursor to the position to change. Each press of the key moves the flashing cursor to the right.

4. Press **DISP** to increase the value at the flashing cursor in increments of 1. The value cannot be decremented.

```
IP Address  SET
192:168:001:002
```

5. Press **STOP** to move the flashing cursor to [SET], and press **DISP** to confirm the setting.

```
IP Address  SET
192:168:001:002
```

6. Press **START/MARK** multiple times until the following setting mode end screen appears.

```
Exit setup mode
EXIT
```

7. Press **DISP** to end setting mode.

```
*Exit Set Mode *
```

An address for identifying individual devices connected to a network. Set an IP address that is not a duplicate of that of another device. If DHCP is set to ON, the setting is configured automatically.

10.7 Subnet Mask

This section describes setting the subnet mask for LAN communication. See "LAN Connection Examples" (p. 71).

1. Turn the power on while pressing **DISP** and then release the key when the model name and version appear in the display area. The instrument enters setting mode.

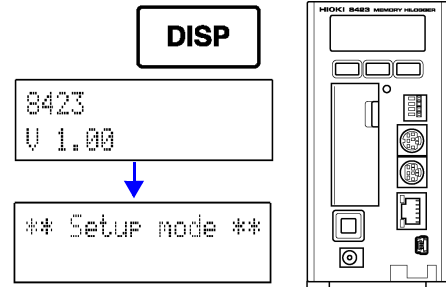

2. Press **START/MARK** multiple times until the following subnet mask setting screen appears.

```
Subnet mask SET
255:255:255:000
```

3. Press **STOP** to move the flashing cursor to the position to change. Each press of the key moves the flashing cursor to the right.

4. Press **DISP** to increase the value at the flashing cursor in increments of 1. The value cannot be decremented.

```
Subnet mask SET
25:255:255:000
```

5. Press **STOP** to move the flashing cursor to [SET], and press **DISP** to confirm the setting.

```
Subnet mask SET
255:255:255:000
```

6. Press **START/MARK** multiple times until the following setting mode end screen appears.

```
Exit setup mode
EXIT
```

7. Press **DISP** to end setting mode.

```
*Exit Set Mode *
```

A setting for separating an IP address into the address portion that indicates the network and the address portion that indicates the device. Set the same setting as that of the subnet mask of devices within the same network. If DHCP is set to ON, the setting is configured automatically.

10.8 Port Number

This section describes setting the port number for LAN communication. See "LAN Connection Examples" (p. 71).

1. Turn the power on while pressing **DISP** and then release the key when the model name and version appear in the display area. The instrument enters setting mode.

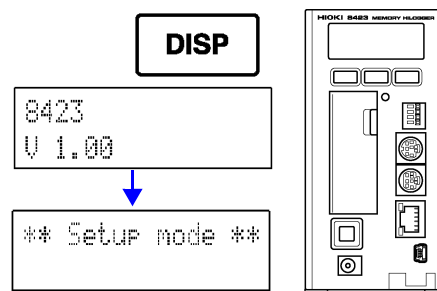

2. Press **START/MARK** multiple times until the following port number setting screen appears.

```
Port number
 800X      SET
```

3. Press **STOP** to move the flashing cursor to the position to change. Each press of the key moves the flashing cursor to the right.
4. Press **DISP** to increase the value at the flashing cursor in increments of 1. The value cannot be decremented.
5. Press **STOP** to move the flashing cursor to [SET], and press **DISP** to confirm the setting.

```
Port number
 880X      SET
```

6. Press **START/MARK** multiple times until the following setting mode end screen appears.

```
Exit setup mode
EXIT
```

7. Press **DISP** to end setting mode.

```
*Exit Set Mode *
```

The logger uses the TCP/IP protocol during communication. TCP/IP allows each communication device to establish multiple connections, so port numbers are used to differentiate between the connections. The logger uses a pre-defined number from 8800 to 8009. There is normally no need to change a port number, but if there is a port that cannot be used because of a network security problem, change the value. The first digit of the port number is reserved.

10.9 Gateway

This section describes setting the gateway for LAN communication. See "LAN Connection Examples" (p. 71).

1. Turn the power on while pressing **DISP** and then release the key when the model name and version appear in the display area. The instrument enters setting mode.

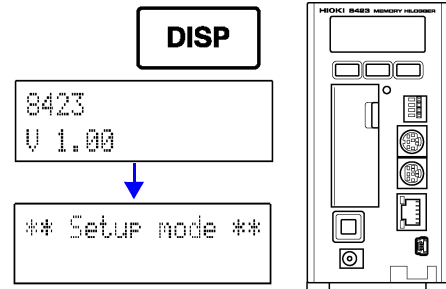

2. Press **START/MARK** multiple times until the following gateway setting screen appears.

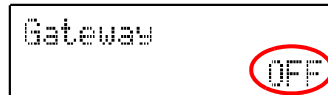

3. Press **DISP** to select ON or OFF for Gateway. Each press of the key toggles the selection item.

4. If the gateway setting was set to ON, press **START/MARK** to display the following gateway setting screen.

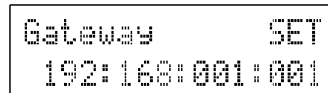

5. Press **STOP** to move the flashing cursor to the position to change. Each press of the key moves the flashing cursor to the right.

6. Press **DISP** to increase the value at the flashing cursor in increments of 1. The value cannot be decremented.

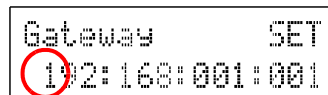

7. Press **STOP** to move the flashing cursor to **[SET]**, and press **DISP** to confirm the setting.

```
Gateway      SET
192:168:001:001
```

8. Press **START/MARK** multiple times until the following setting mode end screen appears.

```
Exit setup mode
EXIT
```

9. Press **DISP** to end setting mode.

```
*Exit Set Mode *
```

When connecting to a network: If the computer is on a different network than the logger, set this to ON and specify the device that will be the gateway. If they are connected to the same network, generally this should be set to same gateway as the computer. When connecting directly to the computer: This setting is not necessary if the computer and logger are connected to the same hub, so set it to OFF. If DHCP is set to ON, the setting is configured automatically.

10.10 Display Language

This section describes setting the display language of the instrument.

1. Turn the power on while pressing **DISP** and then release the key when the model name and version appear in the display area. The instrument enters setting mode.

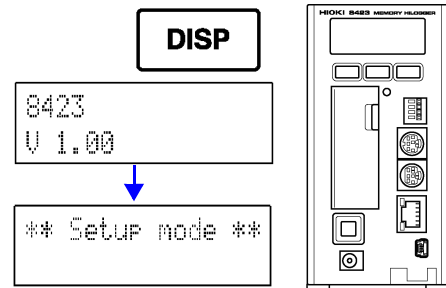

2. Press **START/MARK** multiple times until the following display language setting screen appears.

```
Language
ENGLISH SET
```

3. Press **DISP** to select Japanese or English. Each press of the key toggles the selection item.

4. Press **STOP** to move the flashing cursor to **[SET]**, and press **DISP** to confirm the setting.

```
Language
ENGLISH SET
```

5. Press **START/MARK** multiple times until the following setting mode end screen appears.

```
Exit setup mode
EXIT
```

6. Press **DISP** to end setting mode.

```
*Exit Set Mode *
```

10.11 Self Check

If you perform a self check and the "FAIL" message appears or some kind of abnormality is found, the instrument needs to be repaired.

10.11.1 ROM Check

This section describes checking the internal memory (ROM) of the instrument. The result is displayed in the display area.

1. Turn the power on while pressing **DISP** and then release the key when the model name and version appear in the display area. The instrument enters setting mode.

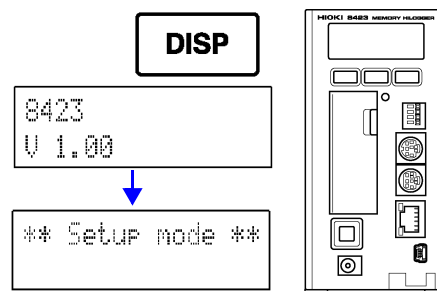

2. Press **START /MARK** multiple times until the following ROM check screen appears.

```
ROM check
DISP key EXECUTE
```

3. Press **DISP** to start the check.

If the result is normal, "PASS" is displayed. If the result is abnormal, "FAIL" is displayed.

```
ROM check: PASS
```

4. Press **START /MARK** to end the display of the result.

5. Press **START /MARK** multiple times until the following setting mode end screen appears.

```
Exit setup mode
EXIT
```

6. Press **DISP** to end setting mode.

```
*Exit Set Mode *
```

10.11.2 RAM Check

This section describes checking the storage RAM, backup RAM, and work RAM of the internal memory (RAM) of the instrument in succession. The result is displayed in the display area.

1. Turn the power on while pressing **DISP** and then release the key when the model name and version appear in the display area. The instrument enters setting mode.

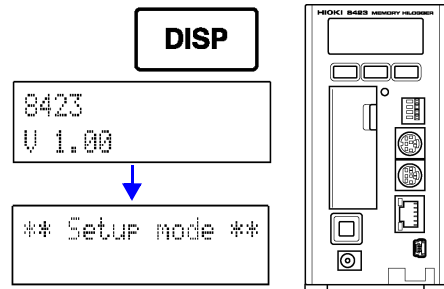

2. Press **START /MARK** multiple times until the following RAM check screen appears.

```
ram check
DISP key EXECUTE
```

3. Press **DISP** to start the check.

The check takes approximately 40 seconds. If the result is normal, "PASS" is displayed. If the result is abnormal, "FAIL" is displayed.

```
ram check: PASS
```

4. Press **START /MARK** to end the display of the result.

5. Press **START /MARK** multiple times until the following setting mode end screen appears.

```
Exit setup mode
EXIT
```

6. Press **DISP** to end setting mode.

```
*Exit Set Mode *
```

10.11.3 BUS Check

This section describes checking the signal line of the internal circuitry of the instrument. The result is displayed in the display area.

1. Turn the power on while pressing **DISP** and then release the key when the model name and version appear in the display area. The instrument enters setting mode.

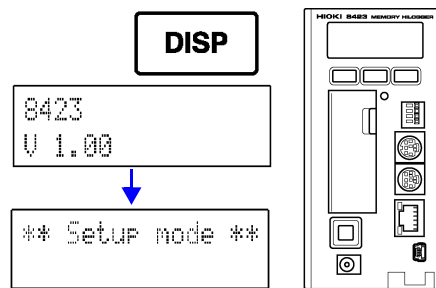

2. Press **START /MARK** multiple times until the following BUS check screen appears.

```
BUS check
DISP key EXEDUTE
```

3. Press **DISP** to start the check.

If the result is normal, "PASS" is displayed. If the result is abnormal, "FAIL" is displayed.

```
BUS check: PASS
```

4. Press **START /MARK** to end the display of the result.

5. Press **START /MARK** multiple times until the following setting mode end screen appears.

```
Exit setup mode
EXIT
```

6. Press **DISP** to end setting mode.

```
*Exit Set Mode *
```

10.11.4 Key Check

This section describes checking whether the keys of the instrument are capable of inputting properly.

1. Turn the power on while pressing **DISP** and then release the key when the model name and version appear in the display area. The instrument enters setting mode.

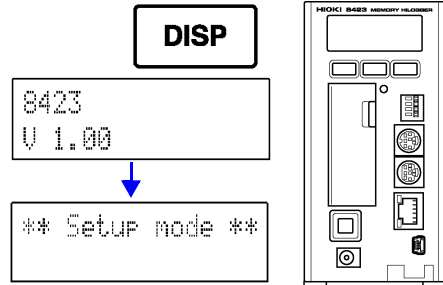

2. Press **START / MARK** multiple times until the following key check screen appears.

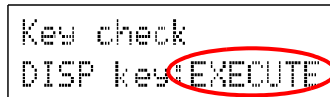

3. Press **DISP** to display the key check screen and then press the three keys on the front of the instrument. When you press a key on the front of the instrument, the corresponding key name in the display area turns black. The check ends when all of the keys are pressed, and then the result appears.

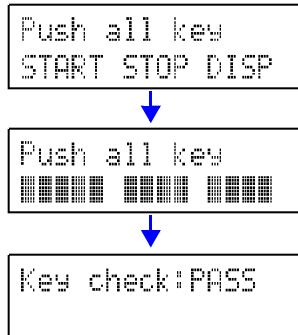

4. Press **START / MARK** to end the display of the result.
5. Press **START / MARK** multiple times until the following setting mode end screen appears.

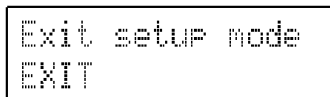

6. Press **DISP** to end setting mode.

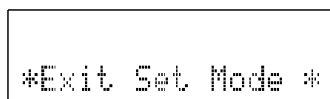

NOTE If a key is abnormal or even one of the keys cannot be recognized, the key check does not end. If it does not end, turn off the power and then submit the instrument for repair, because there is the likelihood that something is abnormal.

10.11.5 LED Check

This section describes checking whether the LEDs of the instrument light properly.

1. Turn the power on while pressing **DISP** and then release the key when the model name and version appear in the display area. The instrument enters setting mode.

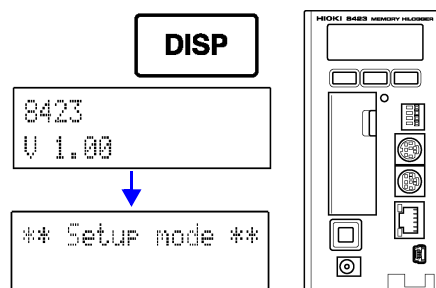

2. Press **START /MARK** multiple times until the following LED check screen appears.

```
LED check
DISP key EXECUTE
```

3. Each press of **DISP** lights an LED in the following order.

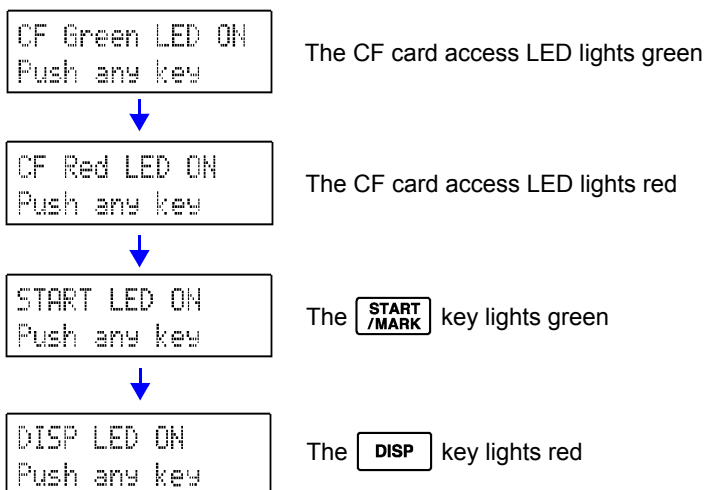

4. Press **DISP** to display the check end screen.

```
LED check finish
Push any key
```

5. Press **START /MARK** to end the check end screen.

6. Press **START /MARK** multiple times until the following setting mode end screen appears.

```
Exit setup mode
EXIT
```

7. Press **DISP** to end setting mode.

```
*Exit Set Mode *
```

10.11.6 LCD Check

This section describes checking the display area of the instrument.

1. Turn the power on while pressing **DISP** and then release the key when the model name and version appear in the display area. The instrument enters setting mode.

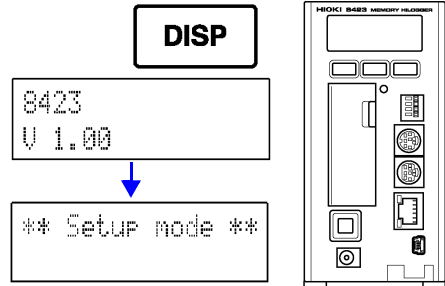

2. Press **START / MARK** multiple times until the following LCD check screen appears.

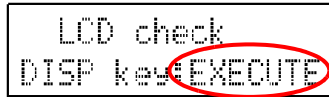

3. Each press of **DISP** changes the display in the following order.

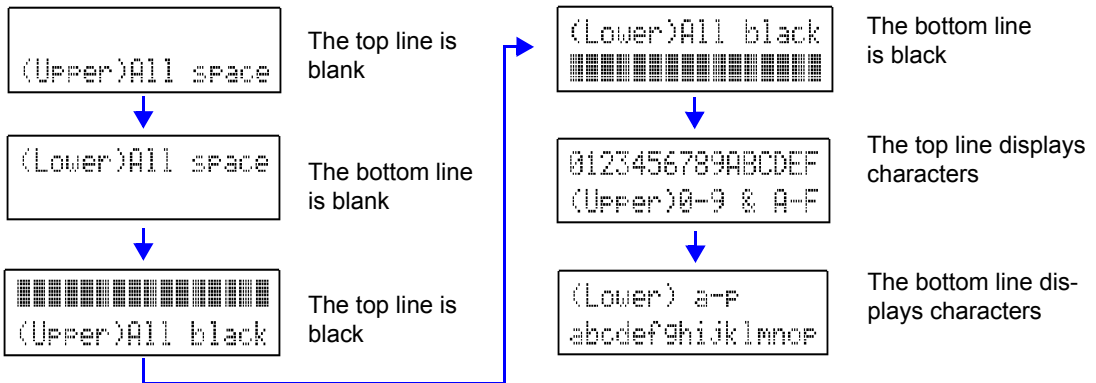

4. Press **DISP** to display the result in the display area.
5. Press **START / MARK** to end the display of the result.
6. Press **START / MARK** multiple times until the following setting mode end screen appears.

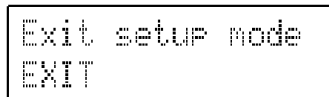

7. Press **DISP** to end setting mode.

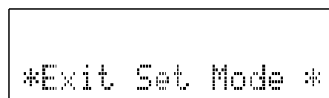

NOTE

If there is an error with the display, submit the instrument for repairs.

10.12 Displaying Individual Version Information

10.12.1 ROM Version

This section describes displaying the ROM version.

1. Turn the power on while pressing **DISP** and then release the key when the model name and version appear in the display area. The instrument enters setting mode.

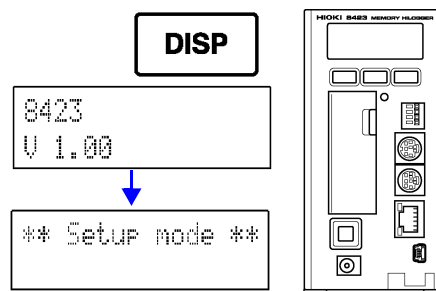

2. Press **START/MARK** multiple times until the following ROM version screen appears.

```
ROM Version
V 1.00
```

(The figure indicates that the ROM version of the instrument is 1.00.)

3. Confirm the version.
4. Press **START/MARK** multiple times until the following setting mode end screen appears.

```
Exit setup mode
EXIT
```

5. Press **DISP** to end setting mode.

```
*Exit Set Mode *
```

10.12.2 FPGA Version

This section describes displaying the FPGA versions of the instrument and each unit connected to the instrument.

1. Turn the power on while pressing **DISP** and then release the key when the model name and version appear in the display area. The instrument enters setting mode.

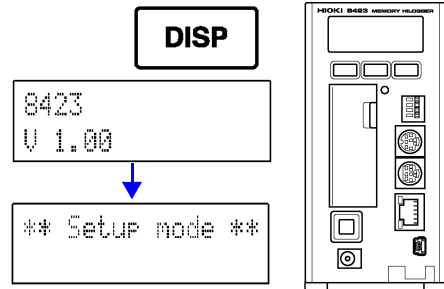

2. Press **START / MARK** multiple times until the following FPGA version screen appears.

```
FPGA Version
L-____0000-R M-0
```

3. Confirm the version.

```
FPGA Version
L-____0000-R M-0
```

This indicates the FPGA version of the 8423 main unit.

The number on the far right indicates the FPGA version of the unit connected on the immediate left of the 8423 main unit. The number on the far left indicates the FPGA version of the unit connected at the very end. If no unit is connected, " _ " is displayed.

4. Press **START / MARK** multiple times until the following setting mode end screen appears.

```
Exit setup mode
EXIT
```

5. Press **DISP** to end setting mode.

```
*Exit Set Mode *
```

10.12.3 MAC Address

This section describes displaying the MAC address of the instrument.

1. Turn the power on while pressing **DISP** and then release the key when the model name and version appear in the display area. The instrument enters setting mode.

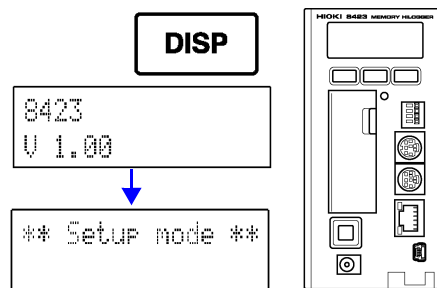

2. Press **START/MARK** multiple times until the following MAC address screen appears.

```
MAC Address
000167-020977
```

(The figure indicates that the unique MAC address set for the instrument is 000167-020977)

3. Confirm the version.
4. Press **START/MARK** multiple times until the following setting mode end screen appears.

```
Exit setup mode
EXIT
```

5. Press **DISP** to end setting mode.

```
*Exit Set Mode *
```

10.12.4 Serial No.

This section describes displaying the Serial No. of the instrument.

1. Turn the power on while pressing **DISP** and then release the key when the model name and version appear in the display area. The instrument enters setting mode.

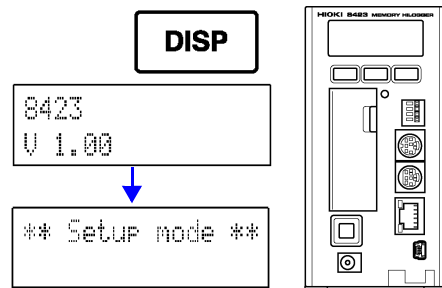

2. Press **START / MARK** multiple times until the following serial No. screen appears.

```
Serial number
070323609
```

(The figure indicates that the serial No. of the instrument is 070323609. The serial No. is the same as that on the sticker affixed to the right side of the instrument)

3. Confirm the version.

4. Press **START / MARK** multiple times until the following setting mode end screen appears.

```
Exit setup mode
EXIT
```

5. Press **DISP** to end setting mode.

```
*Exit Set Mode *
```

10.13 Reading and Writing a Setting File

You can write the setting conditions of the instrument to a CF card. Furthermore, it is also possible to read setting conditions saved to a CF card. You can also use a CF card to copy settings to an 8423 Memory HiLogger that you want to have the same setting conditions.

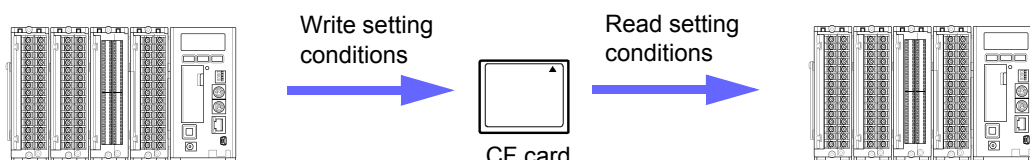

10.13.1 Writing a Setting File

This section describes saving the setting conditions of the instrument to a CF card.

1. Turn the power on while pressing

DISP and then release the key when the model name and version appear in the display area. The instrument enters setting mode.

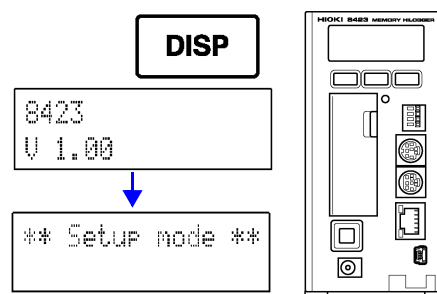

2. Press **START/MARK** multiple times until the following setting file writing screen appears.

```
Save setup file
DISP key EXECUTE
```

3. Open the cover of the CF card slot, and fully insert a CF card.
4. Close the cover, and confirm that the CF card access LED lights green.
5. Press **DISP** to save the setting conditions to the CF card. A setting file named "8423.SET" is saved to the root directory of the CF card.

6. Press **START/MARK** multiple times until the following setting mode end screen appears.

```
Exit setup mode
EXIT
```

7. Press **DISP** to end setting mode.

```
*Exit Set Mode *
```

10.13.2 Reading a Setting File

This section describes using the instrument to read setting conditions saved on a CF card.

1. Turn the power on while pressing **DISP** and then release the key when the model name and version appear in the display area. The instrument enters setting mode.

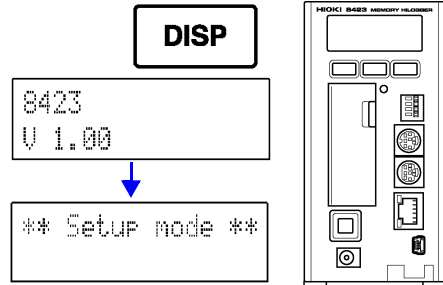

2. Press **START / MARK** multiple times until the following setting file reading screen appears.

```
Load setup file
DISP key EXECUTE
```

3. Open the cover of the CF card slot, and fully insert a CF card.
4. Close the cover, and confirm that the CF card access LED lights green.
5. Press **DISP** to save the setting conditions to the CF card.
6. Press **START / MARK** multiple times until the following setting mode end screen appears.

```
Exit setup mode
EXIT
```

7. Press **DISP** to end setting mode.

```
*Exit Set Mode *
```

NOTE

- Only place one setting file in the root directory of the CF card. It will not be possible to read a setting file if there are two or more setting files.
- It is not possible to read a setting file saved with the supplied software Logger Utility.
- Make the unit configuration of the 8423 that will read the setting file the same as that of the 8423 that was the copy source of the setting file. Measurement cannot be performed properly if the unit configurations are not the same.

Communications (HTTP/FTP) Chapter 11

You can display the main page in a browser on a computer and then control the instrument. The HTTP/FTP function can only be used during communication via a LAN. It is not available during communication via a USB.

11.1 Displaying the Main Page

1. Launch Internet Explorer.
2. Enter the instrument's address in the address bar and the 8423 Main Page will be displayed.
(Enter `http://192.168.1.2` here)

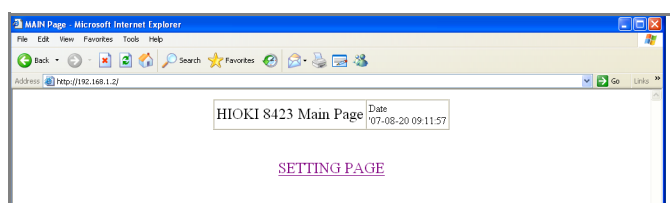

3. Click [SETTING PAGE].
4. The instrument's screen will be displayed in the web browser as-is.

NOTE

- Internet Explorer version 4 or later is supported. Netscape Navigator can also be used, but in such case, part of the browser screen may be unable to operate normally.
- Operation using the HTTP server or FTP server is not possible while measurement is being performed with Logger Utility.



If the HTTP screen does not appear

Choose [Tools] - [Internet Options] on the Internet Explorer tool bar and click on the [Advanced] tab. Check the box for [Use HTTP1.1] and remove the check from the box for [Use HTTP1.1 through proxy connections]. If it is checked. Also, choose the [Connections] tab of [Internet Options], click on the [LAN Settings] button, and remove the check from the box for [Use a proxy server] if it is checked. See "Communication Problems" (p. 73).

11.2 Starting and Stopping Measurement

1. Click **[START/STOP]** on the settings screen. The screen below will be displayed.

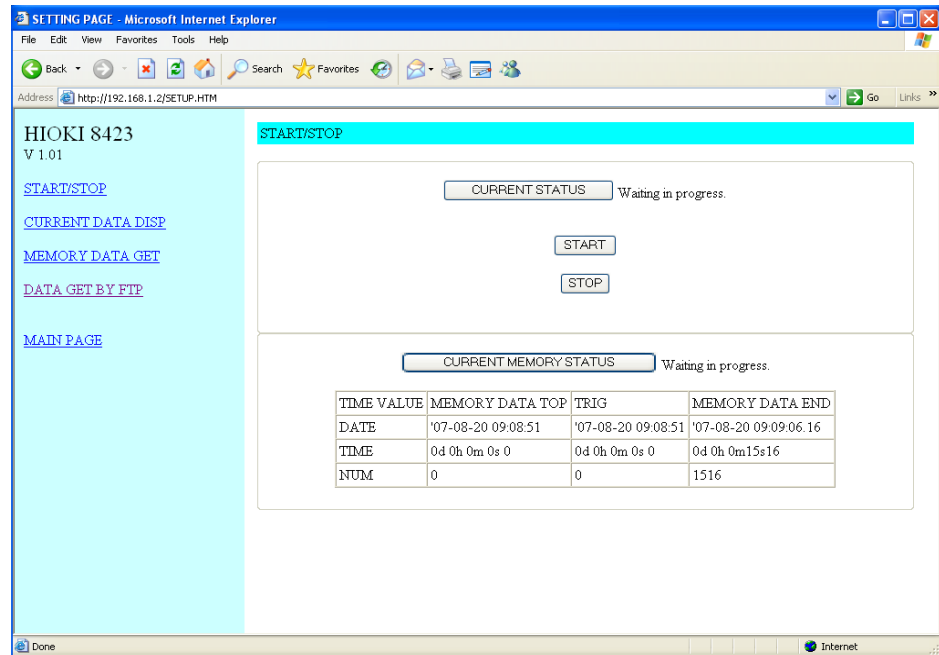

2. Click **[START]**. The instrument's logging measurement will start. You can check the current measurement status on the browser.
3. Click **[STOP]** to stop the measurements.

11.3 Current Value Display

1. Click **[CURRENT DATA DISP]** on the settings screen. The screen below will be displayed.

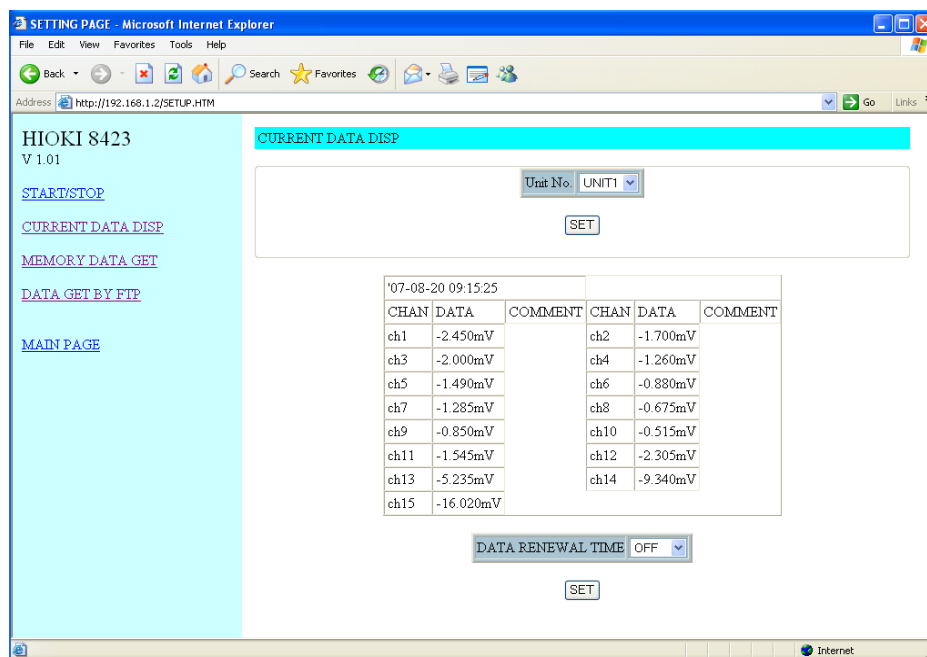

- You can display numerical values of the data being measured by the instrument.
- You can monitor the data obtained for each channel at the recording interval while the instrument is measuring.
- You can even monitor the instantaneous data input to each channel while measurement is stopped on the instrument.

2. To change the screen's renewal rate, set with **[DATA RENEWAL TIME]**.

11.4 Acquiring Data from Memory

1. Click **[MEMORY DATA GET]** on the settings screen. The screen below will be displayed.

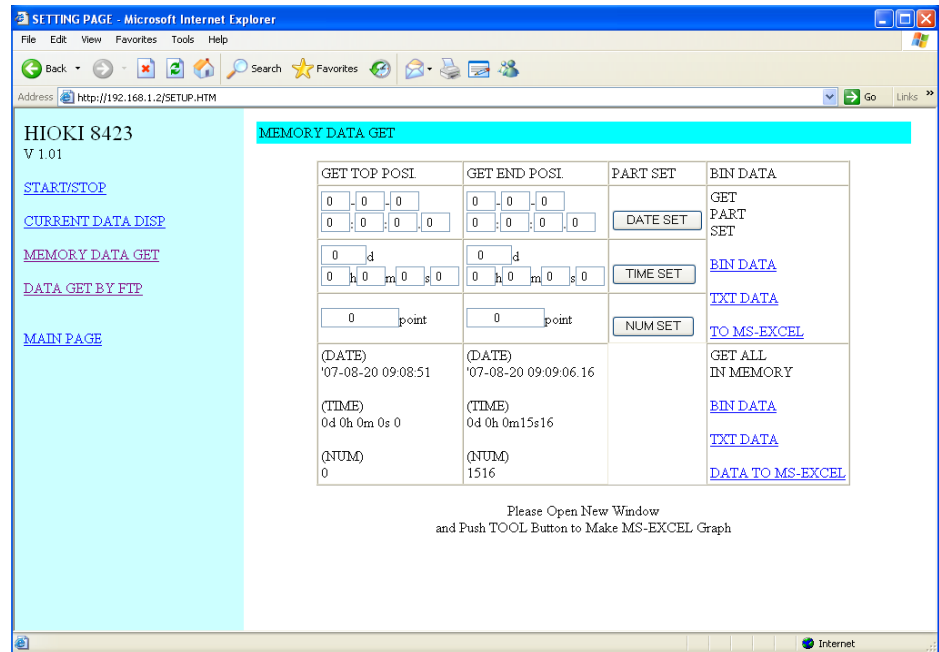

2. Specify and retrieve a range of data saved in the internal memory during the instrument measurement.

You can also retrieve all of the data. You can select binary data and text data. In addition, the data can be transferred to Excel to create graphs as desired.

NOTE

- The updating of the screen (indications for the clock, measurement values, and number of measurement data items) of the instrument may stop temporarily while data is being sent from the instrument to the computer, but the instrument clock and internal operations for measurement are not affected.
- When data is converted to text data, the valid number of digits for numerical data differs between the instrument and Logger Utility. Therefore, there may sometimes be slight discrepancies between the values of the instrument and those of conversion results in Logger Utility due to calculation errors, especially when scaling is used. Furthermore, when the entire internal memory contains measurement data, text conversion performed in the instrument may require several hours to complete because of the calculation speed. Using Logger Utility to convert a file obtained in binary to text is recommended.

11.5 Data Acquisition using FTP

- You can use FTP to obtain files in the CF card and measurement data in internal memory of the instrument.
- It is not possible to obtain measurement data in internal memory during measurement. You can, however, obtain the data after measurement stops.

1. Click **[DATA GET BY FTP]** on the settings screen. The screen below will be displayed.

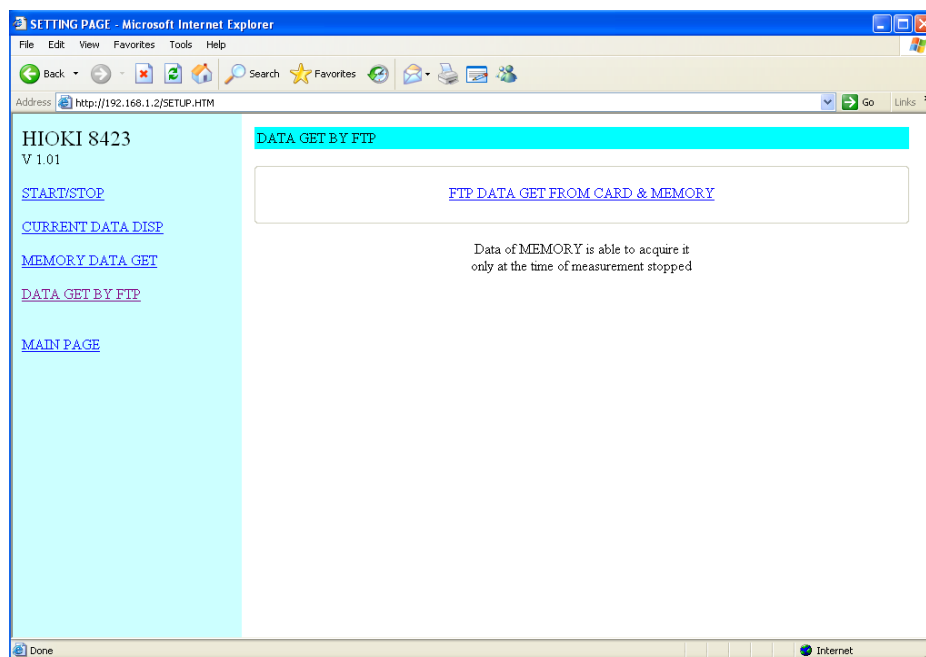

2. Click **[FTP DATA GET FROM CARD & MEMORY]**. You can retrieve the instrument's CF card files and the data containing measurements in internal memory from the web using FTP.
3. If **[FTP/HTTP Authentication]** is **[ON]** on the instrument's Comm screen, you are asked for your user name and password. Enter your user name and password and click **[Set]**.

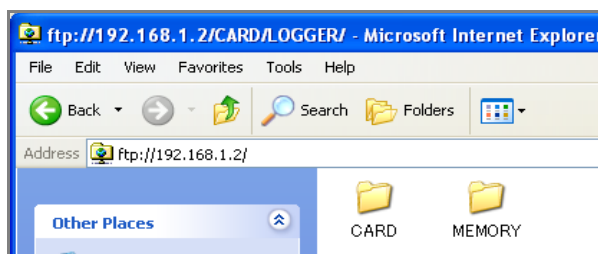

NOTE

- Operation using the FTP server is not possible while measurement is being performed with Logger Utility.
- The updating of the screen (indications for the clock, measurement values, and number of measurement data items) of the instrument may stop temporarily while data is being sent from the instrument to the computer, but the instrument clock and internal operations for measurement are not affected.

NOTE

- Only one connection to the FTP server of the instrument is possible. Simultaneous access from multiple computers is not possible.
- If no command is sent within at least 1 minute after an FTP connection is established, the FTP connection is disconnected. If this happens, establish an FTP connection again.
- If a connection cannot be established when attempting to establish an FTP connection again after an FTP connection was disconnected, wait about 1 minute and then try again.
- In the case of real-time saving of the instrument, only the read operation is possible from an FTP client.
- When you are using FTP to write to a CF card and the auto save function starts, the FTP operation is stopped in order to process saving.
- If the instrument finishes measurement while FTP transfer is being performed, FTP transfer may be ended in order to process saving.
- If you want to exchange the CF card, disconnect the FTP connection first.
- It is possible to use FTP to access the CF card of the instrument from an external device, but do not simultaneously use, for instance, FTP, operations on the instrument, and telnet to perform file operations. Doing so may result in an unintended operation being performed.
- The file update date and time in Internet Explorer may not match that of the logger main unit.
- Internet Explorer keeps the data from the last access in an Internet temporary file, which may sometimes result in you obtaining the data from a previous session rather than the latest data. If the logger data has been updated, restart Internet Explorer before using FTP. (You can use other software such as the free software FFFTP instead of Internet Explorer.)

Although there are various FTP clients for Windows, the standard installation of the operating system allows for FTP commands to be performed with the DOS prompt. Furthermore, you can display the CARD and MEMORY directories by entering an address for the instrument such as ftp://192.168.1.2 in browser software such as Internet Explorer.

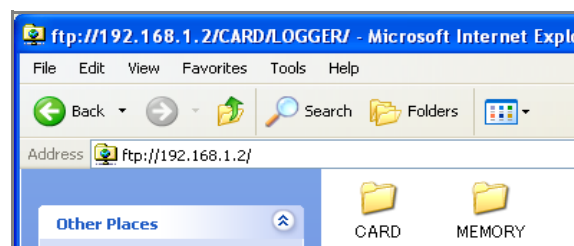

When there is SETUP.SET and measurement data in the MEMORY directory, the MEMORY.MEM and MEMORY.TXT files are available for download to the computer. Files inside CARD can also be downloaded in the same way. You can obtain the measurement data and setting data within the instrument in file format by downloading the files in the MEMORY directory. The files in the CF card of the instrument can be obtained as is from within the CARD directory.

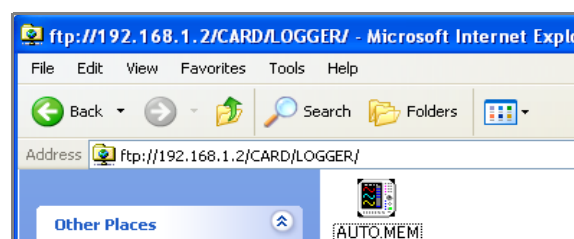

Specifications Chapter 12

12.1 General Specifications

Basic Specifications

Power Supply	Using the 9418-15 AC Adapter Rated supply voltage: 100 to 240 VAC Rated supply frequency: 50/60 Hz Anticipated transient overvoltage: 2500 V External DC power supply: 9.6 V to 15.6 VDC								
Maximum rated power	Using the 9418-15 AC Adapter: 55 VA (AC adapter included), 20 VA (instrument only) [When 8 units are connected] When using an external DC power supply: 20 VA [When 8 units are connected]								
Maximum Number of Units	Up to 8 units can be connected (total number of 8948 Voltage/Temp Units, 8949 Universal Units, 8996 Digital/Pulse Units, and 8997 Alarm Units)								
Memory Capacity	16M Words (total)								
Recording Interval	10 ms, 20 ms, 50 ms, 100 ms, 200 ms, 500 ms, 1 s, 2 s, 5 s, 10 s, 20 s, 30 s, 1 min, 2 min, 5 min, 10 min, 20 min, 30 min, 1 h								
Recording Period	Any recording period or continuous can be set								
Recording Settings	Continuous recording, repeat recording, and timer measurement can be set								
Recording Data Quantity	Analog n channel recording period (16 M/n) data								
Data Storage	The last 16M of data (when recording with 1 channel) is saved to internal memory (16/n data when recording with n channels)								
Backup Battery and Life	Time and Settings: Approx. 10 years (at 23°C/73°F)								
Clock	Auto calendar with automatic leap year, 24-hour clock Clock Accuracy : Power ON ± 0.2 s/ day, Power OFF ± 3 s/ day Time Axis Accuracy : During measurement ± 0.2 s/ day (at 23°C/73°F)								
External Control Input Terminals	<ul style="list-style-type: none"> • External sampling input/trigger input (exclusive use) • External start input • External stop input • GND 								
Size	Approx. 67W x 133H x 125D mm (2.64"W x 5.24"H x 4.92"D) (not including protrusions)								
Weight	Approx. 600 g (21.2 oz.)								
Applying Standards	<table border="0"> <tr> <td>Safety</td> <td>EN61010</td> </tr> <tr> <td>EMC</td> <td>EN61326 Class A</td> </tr> <tr> <td></td> <td>EN61000-3-2</td> </tr> <tr> <td></td> <td>EN61000-3-3</td> </tr> </table>	Safety	EN61010	EMC	EN61326 Class A		EN61000-3-2		EN61000-3-3
Safety	EN61010								
EMC	EN61326 Class A								
	EN61000-3-2								
	EN61000-3-3								

216

12.1 General Specifications

Environmental Specifications

Operating Environment	Indoors, Pollution degree 2, <2000 m (6562 feet) ASL
Operating Temperature and Humidity	Temperature : 0 to 40°C (32 to 104°F) Humidity : 30 to 80%RH (non-condensating)
Storage Temperature and Humidity	Temperature : -10 to 50°C (14 to 122°F) Humidity : 80%RH or less (non-condensating)
Accuracy Guarantee for Temperature and Humidity	Temperature : 23 ± 5°C (73 ± 9°F) Humidity : 30 to 80%RH (non-condensating)
Period of Guaranteed Accuracy	1 year
Product warranty period	3 years

Accessories and Options

Accessories	Quick Start Manual Instruction Manual Model 9418-15 AC Adapter USB cable Logger Utility (data collection program) Connector cover Ferrite Clamp Connection Plate
Options	Model 8948 Voltage/Temp Unit Model 8949 Universal Unit Model 8996 Digital/Pulse Unit Model 8997 Alarm Unit Model 9418-15 AC Adapter Model 9642 LAN Cable Model 9683 Connection Cable (for synchronization) Model 9701 Humidity Sensor Model 9726 PC Card 128M Model 9727 PC Card 256M Model 9728 PC Card 512M Model 9729 PC Card 1G

External Memory

CF Card Slot	One 50-pin slot
Interface	CF (compact flash) card A card compatible with Hioki products Model 9726 PC Card 128M Model 9727 PC Card 256M Model 9728 PC Card 512M Model 9729 PC Card 1G
File System	MS-DOS
Memory Contents	<ul style="list-style-type: none">• Measurement data (binary)• Settings

Communication Specifications

External Interface	<ul style="list-style-type: none">• LAN Interface: IEEE802.3 Ethernet 100BASE-TX DHCP, DNS• USB Interface: Ver 2.0
Control from Computer	<ul style="list-style-type: none">• Data can be collected using Logger Utility• Measurement conditions can be configured using Logger Utility• Data in the internal memory and CF card can be obtained using an FTP server.• Simple operations can be performed using an HTTP server (starting/stopping measurement and obtaining data from the internal memory)

Display

Display Type	LCD
Display Resolution	16 characters x 2 lines, 5 x 8 dots/character
Display Content	<ul style="list-style-type: none"> • Display of measurement values, number of measurement data items, and event marks • Display of time, master/slaves, available CF card space, serial/version number, IP address, and MAC address • Display of errors and warnings <p>(Each press of DISP toggles the above display content and cancels display)</p>
LED	<p>An LED that emits two colors allows for identifying when a compact flash card can be ejected, and when it is being accessed</p> <p>Lit green : Recording to the CF card is possible</p> <p>Lit red : The CF card is being read</p> <p>Off : The CF card can be ejected</p>

Trigger

Trigger System	Digital comparison
Trigger Mode	Single, continuous
Trigger Timing	Start, stop, start and stop
Trigger Sources	<ul style="list-style-type: none"> • Analog inputs Connecting multiple 8948 Voltage/Temp Units and 8949 Universal Units allows for a maximum of 120 channels • Pulse totalization inputs Connecting multiple 8996 Digital/Pulse Units allows for a maximum of 120 channels • Logic inputs Connecting multiple 8996 Digital/Pulse Units allows for a maximum of 120 channels
External Triggers	<p>A trigger is applied on the rise or fall of an external input signal (rise and fall are selectable)</p> <ul style="list-style-type: none"> • Rise A trigger is applied when an input signal rises from a LOW of 0 to 1.0 V to a HIGH of 2.5 to 5.0 V • Fall A trigger is applied when the external trigger terminal is shorted with the GND or when an input signal falls from a HIGH of 2.5 to 5.0 V to a LOW of 0 to 1.0 V <p>VInput voltage range : -5 to 10 VDC External trigger filter : ON and OFF are selectable Response pulse width : When the filter is OFF, the HIGH period is 1 ms or more and the LOW period is 2 μs or more When the filter is ON, the HIGH period is 2.5 ms or more and the LOW period is 4 ms or more</p> <p>External trigger input terminal: Push-button type terminal block</p>
Trigger Conditions	OR and AND of each trigger source. A trigger condition can be set separately for each channel
Trigger Types (Analog and Pulse) *1, *2	<ul style="list-style-type: none"> • Level trigger A trigger is applied when the signal rises (falls) to the set level value • Window trigger A trigger is applied when the signal exits or enters the area set by the trigger level upper limit and lower limit <p>*1: When the 8948 Voltage/Temp Unit or 8949 Universal Unit is connected *2: When the 8996 Digital/Pulse Unit is connected</p>
Trigger Type (Logic) *2	1, 0, and x pattern triggers (x = any state)
Trigger Level Resolution	(Analog) 0.1%f.s. (f.s. = 10 divisions) (Pulse) Integration 1c, revolution 1/n (where n = pulses/rev)
Pre-trigger	Time setting (any) This can also be set when real-time saving

12.1 General Specifications

Alarm

Alarm Output	When the 8997 Alarm Unit is connected (However, alarm output is not possible when only the 8997 Alarm Unit is connected to the 8423 Memory HiLogger. It is only possible when the 8997 Alarm Unit is connected in combination with the 8948 Voltage/Temp Unit, 8949 Universal Unit, or 8996 Digital/Pulse Unit)
Number of Output Channels	15 channels per 8997 Alarm Unit
Alarm Types	<ul style="list-style-type: none"> • Level An alarm is output when the signal rises (falls) to the set level value • Window trigger Set the level upper limit value and lower limit value An alarm is output when the signal exits or enters the area. • Logic pattern
Hold Setting	Hold or non-hold can be set

External Sampling

Sampling Point	Sampling is performed on the rise or fall of an external input signal (rise and fall are selectable) <ul style="list-style-type: none"> • Rise Sampling is performed when an input signal rises from a LOW of 0 to 1.0 V to a HIGH of 2.5 to 5.0 V • Fall Sampling is performed when the external trigger terminal is shorted with the GND or when an input signal falls from a HIGH of 2.5 to 5.0 V to a LOW of 0 to 1.0 V
Input Voltage Range	-5 to 10 VDC
External Sampling Filter	ON and OFF are selectable
Response Pulse Width	When the filter is OFF, the HIGH period is 1 ms or more and the LOW period is 2 μ s or more When the filter is ON, the HIGH period is 2.5 ms or more and the LOW period is 4 ms or more
Maximum External Sampling Frequency	10 ms (when the digital filter is set to OFF) 20 ms (when the digital filter is set to OFF and performing synchronized measurement) 5 s (When the digital filter is set to 50 Hz/60 Hz and performing measurement in combination with humidity measurement)
External Sampling Terminal	Push-button type terminal block

Synchronized Sampling

Synchronization Method	Synchronized sampling is made possible by connecting multiple loggers together with 9683 Connection Cables (for synchronization)
Loggers Capable of Synchronization	8423 Memory HiLogger: Up to 5
Synchronization Cable Connectors	IN side : 9-pin round connector OUT side : 8-pin round connector

Dual Sampling

Recording Interval Types	Two types of recording interval can be set: one for high speed and one for low speed
Possible Recording Interval Settings	An interval can be set for high speed and for low speed from 10 ms, 20 ms, 50 ms, 100 ms, 200 ms, 500 ms, 1 s, 2 s, 5 s, 10 s, 20 s, 30 s, 1 min, 2 min, 5 min, 10 min, 20 min, 30 min, and 1 h (However, these settings are only possible when the ratio of (low-speed recording interval)/(high-speed recording interval) is an integer 1000 or less)

Function

Real-time Saving	The measurement data is saved in binary format to a compact flash card in real time The data can be saved to another file each time Full and Delete and Save are selectable
Marking Function	Each press of  during measurement enables an event mark to be entered
Start Condition Hold Function	Yes

12.2 Application Software

General Specifications

Supplied Media	One CD
Operating Environment	A computer that satisfies the following conditions CPU : Pentium III (500 MHz) or better Memory : At least 512 MB Interface : Ethernet or USB OS : Windows 2000 (with SP4 or later) Windows XP (with SP2 or later) Windows Vista Windows 7 Display : 1024 x 768 dots or better, 65536 colors or more
Compatible Measuring Instrument	HIOKI 8423 Memory HiLogger, 8430 Memory HiLogger, LR8400, LR8401, LR8402 Memory HiLogger, LR8431 Memory HiLogger

Function Specifications

Real-time Data Collection

Overview	The control of the measurement of multiple loggers connected by LAN or USB, and the reception, display, and saving of the waveform data in real time (Total recording sample count: Up to 10 M of samples)
Controllable Memory HiLoggers	5
Data Collection System	1 system (running multiple instances of the application software facilitates multiple system collection)
Display Format	<ul style="list-style-type: none"> • Waveforms (split time-axis display is possible) • Numerical values (logging) • Alarms The above items can be displayed simultaneously
Numerical Value Monitor Display	Display in a separate window is possible.
Scroll	Waveforms can be scrolled during measurement
Data Save Destination	Real-time data collection file (LUW format)
Event Mark	Recording during measurement is possible

Data Collection Settings

Settings	The data collection settings of the Memory HiLogger unit can be configured
Save	The settings of multiple loggers can be saved together to one file (LUS format)
Sending and Receiving of Main Unit Settings	Possible

12.2 Application Software

Waveform Display

Supported Files	Real-time data collection file (LUW format), Main unit measurement file (MEM format)
Display Format	<ul style="list-style-type: none"> • Waveforms (split time-axis display is possible) • Simultaneous display of numerical values (logging) is possible
Maximum Number of Channels	600 channels (measured) + 60 channels (waveform calculation)
Waveform Display Sheets	The waveform of each channel can be displayed on any of the ten sheets
Scroll	Possible
Event Mark Recording	Possible
Cursors	Cursors A and B can be used to display voltage values at the cursor positions.
Hard Copy	A hard copy of the main screen is possible
List Display	Display in a separate window is possible.

Data Conversion

Applicable Data	Real-time data collection file (LUW format), Main unit measurement file (MEM format)
Conversion Section	All data, specified section
Conversion Format	CSV format (comma delimited, space delimited, tab delimited), transfer to Excel sheet
Data Thinning	Simple thinning with any thinning number

Waveform Calculation

Calculation Items	Four arithmetic operations (+, -, *, /)
Number of calculation channel	60 channels

Calculations

Applicable Data	Real-time data collection file (LUW format), Main unit measurement file (MEM format), Data being collected in real time, Waveform calculation data
Calculation Items	Average value, peak value, maximum value, time to maximum value, minimum value, time to minimum value, On time, Off time, On count, Off count, standard deviation, integral, area value and integration

Search

Applicable Data	Real-time data collection file (LUW format), Main unit measurement file (MEM format)
Search Mode	Event mark, date and time, maximum position, minimum position, local maximum position, local minimum position, alarm position, level, window, and variation

Print

Applicable Printer	Printer applicable to the using OS
Applicable Data	Real-time data collection file (LUW format), Main unit measurement file (MEM format)
Print Format	Waveform image, Report print, List print (Channel settings, Event, Cursor value)
Print Area	All area, Specified area by A-B cursor
Print Preview	Available

12.3 Unit Specification

12.3.1 Model 8948 Voltage/Temp Unit

Accuracy applies to 23±5°C (73±9°F), 30 to 80%RH (When executing zero-position adjustment 30 minute after power on)

Input Type	Unbalanced (Isolated between channels)
Number of Input Channels	15 channels (Each channel can be set for voltage, or for a thermocouple)
Input Terminals	M3 screw-type terminal block (two terminals per channel) Detachable terminal block, terminal cover included
Measurement Parameter	Voltage, thermocouple (K, E, J, T, N, W, R, S, B)
Resolution	16 bit
Maximum Sampling Rate	10 ms
Reference Junction Compensation Accuracy	± 0.5°C (K, E, J, T) (Reference Junction Compensation: internally improves accuracy of thermocouple measurements.) ± 1.0°C (N, R, S, B, W)
Temperature Characteristic	To the measurement accuracy add (measurement accuracy × 0.1) per °C
Reference Junction Compensation	Selectable internal or external (measuring with the thermocouple)
Digital Filter	OFF/ 50Hz/ 60Hz (Digital filtering is automatically set to the appropriate recording interval when selecting 50 or 60 Hz.)
Input Resistance	1 MΩ ± 5% (Voltage measurement and temperature measurement with thermocouple when Burn out detection is Off) 850 kΩ ± 5% (Temperature measurement with thermocouple when Burn out detection is On)
Normal Mode Rejection Ratio	50 dB min. (50 Hz input recording at 5 s intervals, with 50 Hz digital filter enabled) (60 Hz input recording at 5 s intervals, with 60 Hz digital filter enabled)
Common Mode Rejection Ratio	100 dB min. (at 50/60 Hz, digital filter OFF with signal source resistance 100 Ω max.) 140 dB min. (50 Hz input from signal source resistance of 100 Ω or less recording at 5 s intervals, with 100 mV f.s. range selected and 50 Hz digital filter enabled), (60 Hz input from signal source resistance of 100 Ω or less recording at 5 s intervals, with 100 mV f.s. range selected and 60 Hz digital filter enabled)
Maximum Input Voltage	100 VDC
Maximum Rated Voltage between Channels	200 VDC
Maximum Rated Voltage to Earth	600 Vrms or 600 VDC (between each input channel and main unit, and between each unit), Measurement category II, (anticipated transient overvoltage 4000 V)
Dielectric Strength	4.29 kVAC for 1 minute (between each input channel and main unit, and between each unit) 350 VAC for 1 minute (between each input channels)
Location for Use	Altitude up to 2000 m (6562 feet), indoors, Pollution degree 2
Operating Temperature and Humidity	Temperature : 0 to 40°C (32 to 104°F) Humidity : 30 to 80%RH (no condensation)
Storage Temperature and Humidity	Temperature : -10 to 50°C (14 to 122°F), Humidity : 80%RH or less (no condensation)
Accuracy Guarantee for Temperature and Humidity	Temperature : 23 ± 5°C (73 to 9°F), Humidity : 30 to 80%RH (no condensation)
Period of Guaranteed Accuracy	1 year
Dimensions	Approx. 38.5W × 133H × 141.2D mm (1.52"W × 5.24"H × 5.56"D) (excluding projections)
Mass	Approx. 550 g (19.4 oz.)
Effect of Conducted Radio-Frequency Electromagnetic Field	Within ± 2%f.s. at 3 V
Effect of Radiated Radio-frequency Electromagnetic Field	Within ± 2%f.s. at 3 V/m
Accessories	Instruction Manual, Connection Plate
Applying Standards	Safety EN61010 EMC EN61326 Class A
Product warranty period	3 years

12.3.2 Model 8949 Universal Unit

Accuracy applies to 23±5°C (73±9°F), 30 to 80%RH (When executing zero-position adjustment 30 minute after power on)

Input Type	Unbalanced (Isolated between channels) (except resistance temperature detector and humidity sensor channels, which are not isolated)
Number of Input Channels	15 channels (Each channel can be set for voltage, thermocouple, resistance temperature detector or humidity sensor)
Input terminals	Push-type terminal block (four terminals per channel) Detachable terminal block, terminal cover included
Measurement Parameter	Voltage, thermocouple (K, E, J, T, N, W, R, S, B), Resistance temperature detector (Pt 100, JPt 100) (3- or 4-wire connection, 1 mA measurement current), Humidity (requires optional Model 9701 Humidity Sensor)
Resolution	16 bit
Maximum Sampling Rate	10 ms (5 s when also measuring humidity)
Reference Junction Compensation Accuracy	± 0.5°C (K, E, J, T) (Reference Junction Compensation: internally improves accuracy of thermocouple measurements), ±1.0°C (N, R, S, B, W)
Temperature Characteristic	To the measurement accuracy add (measurement accuracy × 0.1) per °C
Reference Junction Compensation	Selectable internal or external (measuring with the thermocouple)
Digital Filter	OFF/ 50 Hz/ 60 Hz (Digital filtering is automatically set to the appropriate recording interval when selecting 50 or 60 Hz.)
Input Resistance	1 MΩ ± 5% (Voltage measurement and temperature measurement with thermocouple when Burn out detection is Off), 2 MΩ ± 5% (Temperature measurement with resistance temperature detector), 850 kΩ ± 5% (Temperature measurement with thermocouple when Burn out detection is On)
Normal Mode Rejection ratio	50 dB min. (50 Hz input recording at 5 s intervals, with 50 Hz digital filter enabled) (60 Hz input recording at 5 s intervals, with 60 Hz digital filter enabled)
Common Mode Rejection Ratio	100 dB min. (at 50/60 Hz, digital filter OFF with signal source resistance), 140dB min. (50 Hz input from signal source resistance of 100 Ω or less recording at 5 s intervals, with 50 Hz digital filter enabled), (60 Hz input from signal source resistance of 100 Ω or less recording at 5 s intervals, with 60 Hz digital filter enabled)
Maximum Input Voltage	60 VDC
Maximum Rated Voltage between Channels	120 VDC
Maximum Rated Voltage to Earth	600 Vrms or 600 VDC (between each input channel and main unit, and between each unit), Measurement category II (anticipated transient overvoltage 4000 V)
Dielectric Strength	4.29 kVAC for 1 minute (between each input channel and main unit, and between each unit), 350 VAC for 1 minute (between each input channels)
Location for Use	Altitude up to 2000 m (6562 feet), indoors, Pollution degree 2
Operating Temperature and Humidity	Temperature : 0 to 40°C (32°F to 104°F) Humidity : 30 to 80%RH (no condensation)
Storage Temperature and Humidity	Temperature : -10 to 50°C (14°F to 122°F), Humidity : 80%RH or less (no condensation)
Accuracy Guarantee for Temperature and Humidity	Temperature : 23 ± 5°C (73°F to 9°F), Humidity : 30 to 80%RH (no condensation)
Period of Guaranteed Accuracy	1 year
Dimensions	Approx. 38.5W × 133H × 141.2D mm (1.52"W × 5.24"H × 5.56"D) (excluding projections)
Mass	Approx. 530 g (18.7 oz.)
Effect of Conducted Radio-frequency Electromagnetic Field	Within ± 2%f.s. at 3 V
Effect of Radiated Radio-Frequency Electromagnetic Field	Within ± 2%f.s. at 3 V/m
Accessory	Flathead screwdriver (for terminal block) x 1, Instruction Manual, Connection Plate
Applying Standards	Safety EN61010 EMC EN61326 Class A
Product warranty period	3 years

12.3 Unit Specification

Measurement Range/ Measurable Range/ Resolution/ Measurement Accuracy

Measurement Parameter	Measurement Range	Measurable Range	Maximum Resolution	Measurement Accuracy		
Voltage	100 mV f.s.	-150 to 150 mV	5 μ V	$\pm 0.1\%$ f.s.		
	1 V f.s.	-1.5 to 1.5 V	50 μ V			
	10 V f.s.	-15 to 15 V	500 μ V			
	20 V f.s.	-30 to 30 V	1 mV			
	100 V f.s.	-60 to 60 V	5 mV			
	1-5 V f.s. *1	1 to 5 V	500 μ V			
Thermocouple (not including increased accuracy of reference junction compensation)	K *2	100°C f.s.	-100 to 100°C	0.01°C	$\pm 0.05\%$ f.s. $\pm 1^\circ\text{C}$	
		500°C f.s.	-200 to 500°C	0.05°C		
		2000°C f.s.	-200 to 1350°C	0.1°C		
	E *2	100°C f.s.	-100 to 100°C	0.01°C		
		500°C f.s.	-200 to 500°C	0.05°C		
		2000°C f.s.	-200 to 1000°C	0.1°C		
	J *2	100°C f.s.	-100 to 100°C	0.01°C		
		500°C f.s.	-200 to 500°C	0.05°C		
		2000°C f.s.	-200 to 1200°C	0.1°C		
	T *2	100°C f.s.	-100 to 100°C	0.01°C		
		500°C f.s.	-200 to 400°C	0.05°C		
		2000°C f.s.	-200 to 400°C	0.1°C		
	N *2	100°C f.s.	-100 to 100°C	0.01°C		
		500°C f.s.	-200 to 500°C	0.05°C		
		2000°C f.s.	-200 to 1300°C	0.1°C		
	R *2	100°C f.s.	0 to 100°C	0.01°C		$\pm 0.05\%$ f.s. $\pm 3.5^\circ\text{C}$ (0 to $<400^\circ\text{C}$) (except Type B, for which accuracy below 400°C is not guaranteed) $\pm 0.05\%$ f.s. $\pm 2^\circ\text{C}$ (400°C min.)
		500°C f.s.	0 to 500°C	0.05°C		
		2000°C f.s.	0 to 1700°C	0.1°C		
	S *2	100°C f.s.	0 to 100°C	0.01°C		
		500°C f.s.	0 to 500°C	0.05°C		
		2000°C f.s.	0 to 1700°C	0.1°C		
	B *2	2000°C f.s.	0 to 1800°C	0.1°C		
		W *3 (Wre 5-26)	100°C f.s.	0 to 100°C		
		Pt100 *4	100°C f.s.	-100 to 100°C		
500°C f.s.			-200 to 500°C	0.05°C		
2000°C f.s.			-200 to 800°C	0.1°C		
JPt100 *5	100°C f.s.	-100 to 100°C	0.01°C			
	500°C f.s.	-200 to 500°C	0.05°C			
	2000°C f.s.	-200 to 500°C	0.1°C			
Resistance temperature detector	100%RH	5.0 to 95.0%RH	0.1%RH	See table on next page (including accuracy of 9701 HUMIDITY SENSOR)		

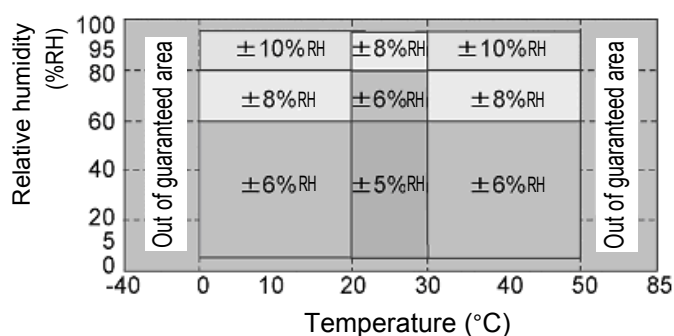

Table 1. Humidity Accuracy

Recording Interval and Cutoff Frequency Table

Recording Interval Digital Filter	10 ms ^{*6}	20 ms ^{*6}	50 ms ^{*6}	100ms ^{*6}	200ms ^{*6}	500ms ^{*6}	1 s ^{*6}	2 s ^{*6}	5 s	10 s	20 s or more
50 Hz	20.833 kHz	9 kHz	3.375 kHz	1.687 kHz	852 Hz	330.6 Hz	165.3 Hz	83.08 Hz	50 Hz	50 Hz	10 Hz
60 Hz	20.833 kHz	9 kHz	3.375 kHz	1.687 kHz	852 Hz	330.6 Hz	165.3 Hz	83.08 Hz	60 Hz	60 Hz	10 Hz
OFF	20.833 kHz	20.833 kHz	20.833 kHz	20.833 kHz	20.833 kHz	20.833 kHz	20.833 kHz	20.833 kHz	20.833 kHz ^{*7}	20.833 kHz ^{*7}	20.833 kHz ^{*8}

*1 The upper limit 5 V and the lower limit 1 V of the 10 Vf.s. range are set automatically. The resolution is the same as for the 10 Vf.s. range.

*2 JIS C 1602-1995

*3 ASTM E-988-96

*4 JIS C 1604-1997

*5 JIS C 1604-1989

*6 Cannot be set when in combination with humidity measurement.

*7 112.5 Hz when in combination with humidity measurement.

*8 10 Hz when in combination with humidity measurement.

12.3.3 Model 8996 Digital/Pulse Unit

Number of Input Channels	15 channels
Input Terminals	M3 screw-type terminal block (two terminals per channel)
Input Types	Digital or pulse input (selectable for each channel)
Input Compatibility	No-voltage contact (always-open connection) connection, open collector or voltage input
Input Resistance	1.1 M Ω \pm 5%
Maximum Input Voltage	50 VDC
Maximum Rated Voltage to Earth	600 Vrms or 600 VDC (between each input of channels 1 to 5 and main unit, between each input of channels 6 to 10 and main unit, between each input of channels 11 to 15 and main unit, and between each unit) Measurement category II (anticipated transient overvoltage 4000 V)
Maximum Rated Voltage between Channels	33 Vrms or 70 VDC (between each input of channels 1 to 5 and 6 to 10, between each input of channels 6 to 10 and 11 to 15, between each input of channels 1 to 5 and 11 to 15), (Channel blocks 1 to 5, 6 to 10 and 11 to 15 each share common grounds)
Dielectric Strength	4.29 kVAC for 1 minute (between each input of channels 1 to 5 and main unit, between each input of channels 6 to 10 and main unit, between each input of channels 11 to 15 and main unit, and between each unit) 350 VAC for 1 minute (between each input of channels 1 to 5 and 6 to 10, between each input of channels 6 to 10 and 11 to 15, between each input of channels 1 to 5 and 11 to 15)
Detection Level Types	2 types (selectable for each channel)
Detection Levels	HIGH 1.0 V or higher LOW 0 to 0.5 V HIGH 4.0 V or higher LOW 0 to 1.5 V
Location for Use	Altitude up to 2000 m (6562 feet), indoors Pollution degree 2
Operating Temperature and Humidity	Temperature : 0 to 40°C (32°F to 104°F) Humidity : 30 to 80%RH (no condensation)
Storage Temperature and Humidity	Temperature : -10 to 50°C (14°F to 122°F), Humidity : 80%RH or less (no condensation)
Dimensions	Approx. 38.5W \times 133H \times 141.2D mm (1.52"W \times 5.24"H \times 5.56"D) (excluding projections)
Mass	Approx. 500 g (17.6 oz.)
Accessories	Instruction Manual, Connection Plate
Applying Standards	Safety EN61010 EMC EN61326 Class A
Product warranty period	3 years

Pulse Input

Measurement Parameters	Pulse Totalization (add, instant) ,Rotation Rate
Pulse Input Period	With filter Off: At least 200 μ s (high and low periods must be at least 100 μ s) With filter On: At least 100 ms (high and low periods must be at least 50 ms)
Chattering Prevention Filter	Set On/Off for each channel
Slope	Rising- and falling-edge settings available for each channel
Functions	Totalization, Rotation Rate

Measurement Ranges/ Resolution

Measurement Objects	Range	Measurable Range	Maximum Resolution
Pulse Totalization	1,000 M pulse f.s.	0 to 1,000 M pulse	1 pulse
Rotation Rate	5,000/n r/s f.s.	0 to 5,000/n r/s	1/n r/s

“n” is the number of pulses per rotation, from 1 to 1,000

Digital Input

Recording Interval	10 ms, 20 ms, 50 ms, 100 ms, 200 ms, 500 ms, 1 s, 2 s, 5 s, 10 s, 20 s, 30 s, 1 min, 2 min, 5 min, 10 min, 20 min, 30 min, 1 h
--------------------	--

12.3.4 Model 8997 Alarm Unit

Number of Output Channels	15 channels Up to 15 output channels are available for analog, pulse and digital inputs (each output channel is isolated from the others and from the 8423 HiLogger).
Output Terminals	M3 screw-type terminal block (two terminals per channel)
Output Type	Open collector (active low)
Maximum Switching Capacity	5 to 60 VDC, 10 mA
Output Refresh	Once each recording interval
Maximum Rated Voltage to Earth	600 Vrms or 600 VDC (between each output channel and main unit, and between each unit)
Maximum Rated Voltage between Channels	33 Vrms or 70 VDC (between each output channels)
Dielectric Strength	4.29 kVAC for 1 minute (between each output channel and main unit, and between each unit) 350 VAC for 1 minute (between each output channels)
Location for Use	Altitude up to 2000 m (6562 feet), indoors, Pollution degree 2
Operating Temperature and Humidity	Temperature : 0 to 40°C (32°F to 104°F) Humidity : 30 to 80%RH (no condensation)
Storage Temperature and Humidity	Temperature : -10 to 50°C (14°F to 122°F) Humidity : 80%RH or less (no condensation)
Dimensions	Approx. 38.5W × 133H × 141.2D mm (1.52"W × 5.24"H × 5.56"D) (excluding projections)
Mass	Approx. 500 g (17.6 oz.)
Accessories	Instruction Manual, Connection Plate
Applying Standards	Safety EN61010 EMC EN61326 Class A
Product warranty period	3 years

12.4 Dimension Diagrams

Model 8423 Memory HiLogger
Main Unit

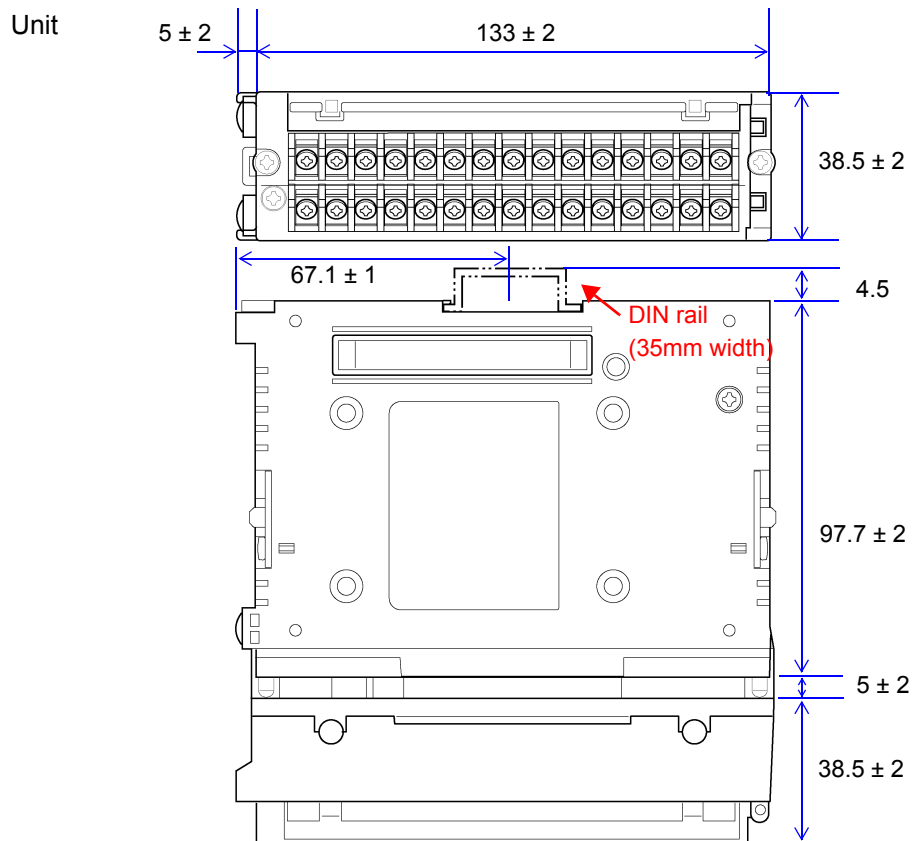
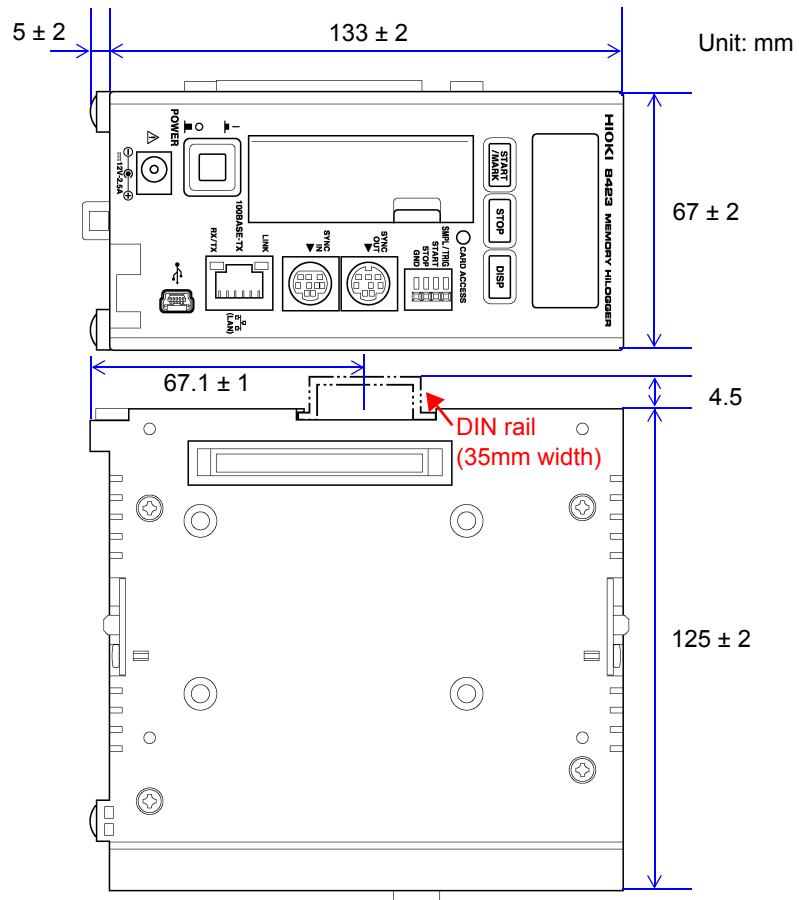

When units are connected

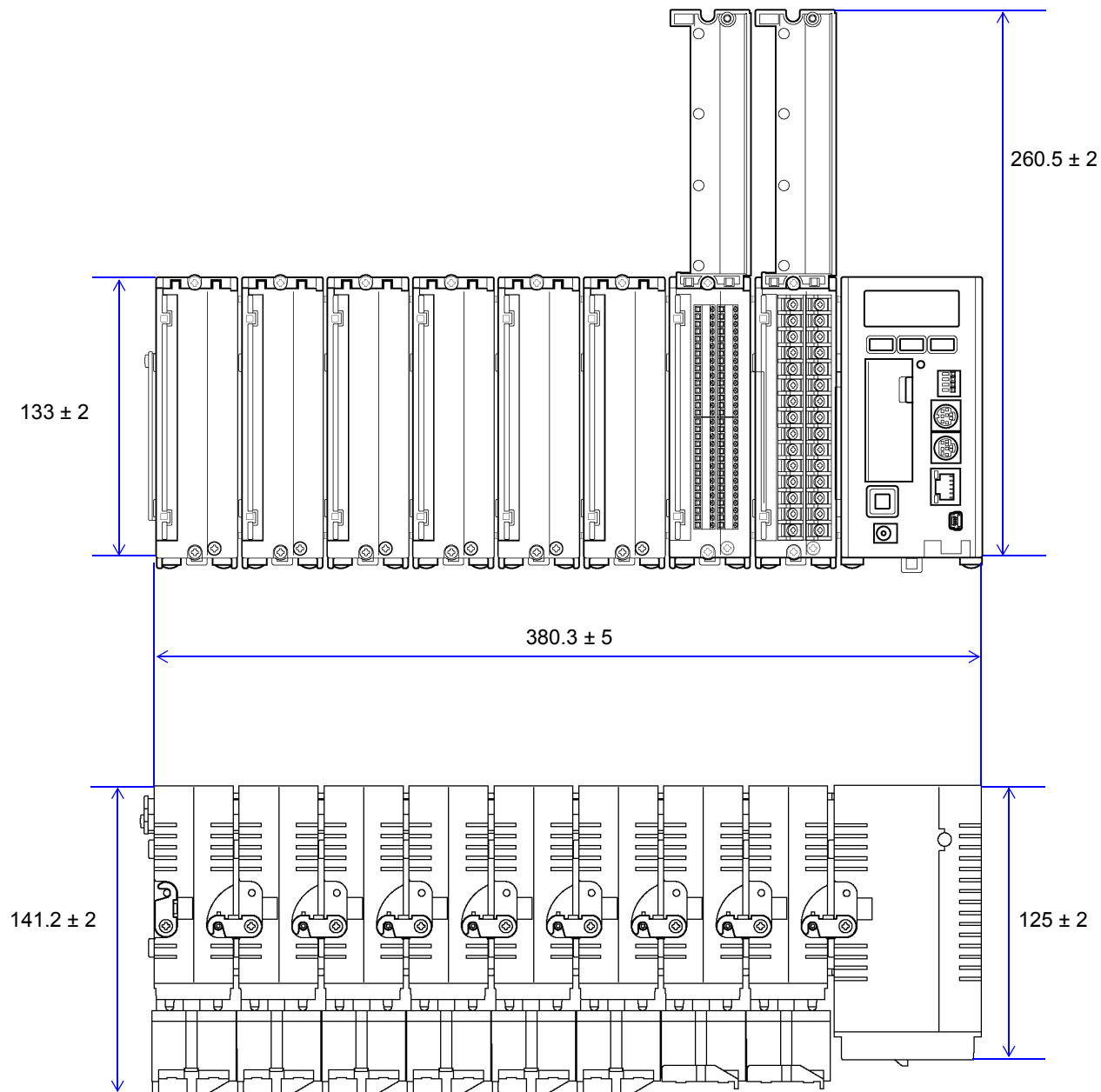

Maintenance and Service

Chapter 13

WARNING

Do not attempt to modify, disassemble or repair the instrument as fire, electric shock and injury could result.

Shipping Precautions

- Use the original packing materials when transporting the instrument, if possible.
- Pack the instrument so that it will not sustain damage during shipping, and include a description of existing damage. We cannot accept responsibility for damage incurred during shipping.
- To avoid damage to the instrument, be sure to remove the CF card and cables before shipping.

List of Replacement Parts

Useful life depends on the operating environment and frequency of use. Operation cannot be guaranteed beyond the following periods. For replacement parts, contact your dealer or Hioki representative.

Part	Life
Electrolytic capacitor	Approximately 10 years
Electric double-layer capacitor	Approximately 3 years The instrument has a built-in electric double-layer capacitor to assure file integrity. Once file integrity is no longer protected during power outages, the capacitor needs to be replaced.
Lithium battery	Approximately 10 years

Note: The service lives of these components may be shortened dramatically if the instrument is used in a high-temperature environment.

- The fuse is housed in the power unit of the instrument. If the power does not turn on, the fuse may be blown. If this occurs, a replacement or repair cannot be performed by customers. Please contact your dealer or Hioki representative.
- The instrument contains a built-in backup lithium battery. If the date and time deviate substantially when the instrument is switched on, it is the time to replace that battery. Contact your dealer or Hioki representative.

13.1 Cleaning

To clean the instrument, wipe it gently with a soft cloth moistened with water or mild detergent. Never use solvents such as benzene, alcohol, acetone, ether, ketones, thinners or gasoline, as they can deform and discolor the case.

NOTE

Wipe the LCD gently with a soft, dry cloth.

13.2 Troubleshooting

If damage is suspected, check the "Troubleshooting" section before contacting your dealer or Hioki representative.

Before Returning for Repair

If the instrument is not operating normally, check the following items.

Symptom	Check Item
Nothing is indicated on the display when the power is turned on.	<ul style="list-style-type: none"> Is the AC adapter connected properly? Has the fuse of the power supply unit blown? The power supply unit of the instrument includes a built in fuse. If the instrument cannot be powered on, the fuse may have blown. Contact your dealer or Hioki representative because the power supply unit is designed in such a way that the fuse cannot be replaced or repaired by a user.
Unable to communicate with a computer.	<ul style="list-style-type: none"> Is the LAN cable or USB cable disconnected? If you are using LAN to connect to the computer directly on a one-to-one basis, are you using cross cable for the LAN cable? If you are using USB to connect, is the USB driver installed? Are the IP address, subnet mask, and gateway settings correct?
No measurement values are indicated on the display even if  is pressed	<ul style="list-style-type: none"> Is the instrument in setting mode? Is an indication other than the measurement value (number of measurement data items, number of event marks, or CF card remaining space) set? Is the "Waiting for Trigger," "Waiting for Pre-trigger," or "Waiting for Data" message displayed? Is the measurement channel setting of each channel set to OFF? Is each of the units connected to the 8423 Memory HiLogger properly? Are 9 units or more connected?
There is absolutely no change in the waveforms in the waveform display area of the application software.	<ul style="list-style-type: none"> Is an appropriate measurement range set? Are the input cables connected properly?
Unable to save to the CF card.	<ul style="list-style-type: none"> Are you using Hioki's optional CF card (PC card)? Is the CF card inserted properly? Was the cover closed after inserting the CF card? Is the CF card formatted? Is the CF card remaining space insufficient?
A very different date and time are displayed at power on.	<ul style="list-style-type: none"> The life of the backup battery is approximately 10 years. A very different date and time at power on indicates that it is time to replace the battery. Contact your dealer or Hioki representative.

If you are still unsure of the cause after checking the above items, try resetting the system. The settings will be reset to the factory defaults. Also refer to, for example, "Error Messages and Troubleshooting" and "Index."

13.3 Initializing Settings (System Reset)

This section describes initializing settings by turning on the power while pressing **STOP**. All setting items will be reset to their factory defaults except those related to communication.

1. Turn the power on while pressing **STOP** and then release the key when **[Remote Mode]** appears in the display area.

* Do not remove your finger from **STOP** until the mark is fully displayed. The process will be canceled if you remove your finger too early.

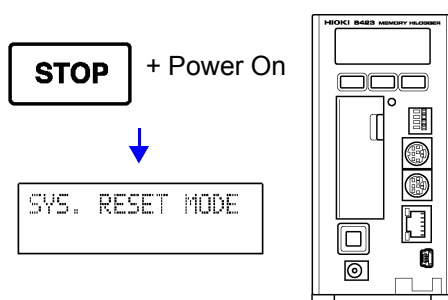

2. Press **DISP** for at least 1 second while **[Remote Mode]** is indicated in the display area.

A system reset is executed. If no key is pressed or **STOP** is pressed, the system reset is cancelled.

SYSTEM RESET
COMPLETED.

NOTE

To reset all setting items to their factory defaults including those related to communication, turn on the power while simultaneously pressing **START/MARK** and **STOP**. Execute a full reset in the same way as the system reset procedure described above.

13.4 Zero-position Calibration (Zero Adjustment)

The zero position may shift over time. You can use the procedure below to zero-position calibrate all analog input channels of the 8948 Voltage/Temp Units and 8949 Universal Units connected to the instrument.

1. Turn the power on while pressing **DISP** and then release the key when the model name and version appear in the display area. The instrument enters setting mode.

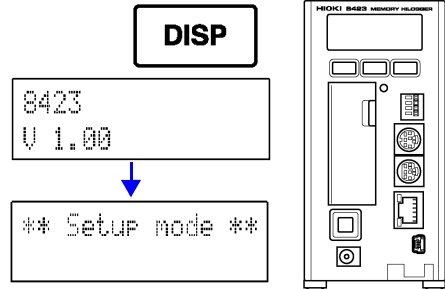

2. Press **START/MARK** multiple times until the following zero-adjustment execution screen appears.

```
Zero adjust
DISP key:EXECUTE
```

3. Press **DISP** to start zero adjustment. Zero adjustment takes approximately 1 minute to finish.

```
Zero adjusting.. (While executing zero adjustment)
Wait 1 minute
```

```
Adj completed (When zero adjustment is finished)
Push any key
```

4. Press **DISP** to end the zero adjustment end screen.

5. Press **START/MARK** multiple times until the following setting mode end screen appears.

```
Exit setup mode
EXIT
```

6. Press **DISP** to end setting mode.

```
*Exit Set Mode *
```

NOTE

- To ensure zero-position calibration is accurate, disconnect any cables connected to the terminal blocks of the 8948 Voltage/Temp Units and 8949 Universal Units connected to the instrument. Also, be sure to perform calibration while the terminal blocks are mounted to the units.
- When carrying out temperature measurement with a thermocouple (reference junction compensation: internal), it is not possible to adjust the channels to a certain temperature or correct differences between the measurement values of the channels.

13.5 Industrial Waste

Before discarding the instrument, remove the lithium battery and dispose of it in accordance with the local regulations.

! WARNING

- To avoid electric shock, turn off the power switch and disconnect the cables before removing the lithium battery.
- Keep batteries away from children to prevent accidental swallowing.
- Handle and dispose of batteries in accordance with local regulations.

Required tools: Phillips screwdriver (M3)..... 1
Wire cutters..... 1

- 1. Turn off the power of the instrument.**
Disconnect any connected cables.
- 2. Place the instrument so that the left side is facing up, use the screwdriver to remove the four screws, and then remove the instrument casing and internal plates.**
- 3. Release the levers of connectors with flat cables inserted, and pull out the flat cables from the connectors.**
- 4. Remove the printed-circuit board.**
- 5. Use the screwdriver to remove the screws securing the other printed-circuit board, and then remove the printed-circuit board.**
- 6. Lift up the battery, and then use the wire cutters to cut the positive (+) connection.**
- 7. Lift the battery up further, and then use the wire cutters to cut the negative (-) connection hidden beneath the battery.**

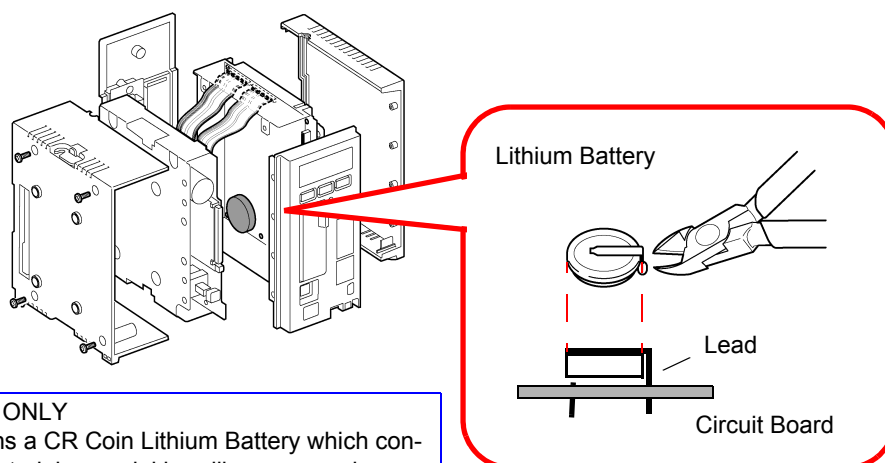

CALIFORNIA, USA ONLY
This product contains a CR Coin Lithium Battery which contains Perchlorate Material - special handling may apply.
See www.dtsc.ca.gov/hazardouswaste/perchlorate

Appendix

Appendix 1 Scan Timing

For sampling of the 8948 Voltage/Temp Unit and 8949 Universal Unit, there is a scan system for each channel. The figure below shows scanning when the digital filter is off and the recording interval is 10 ms.

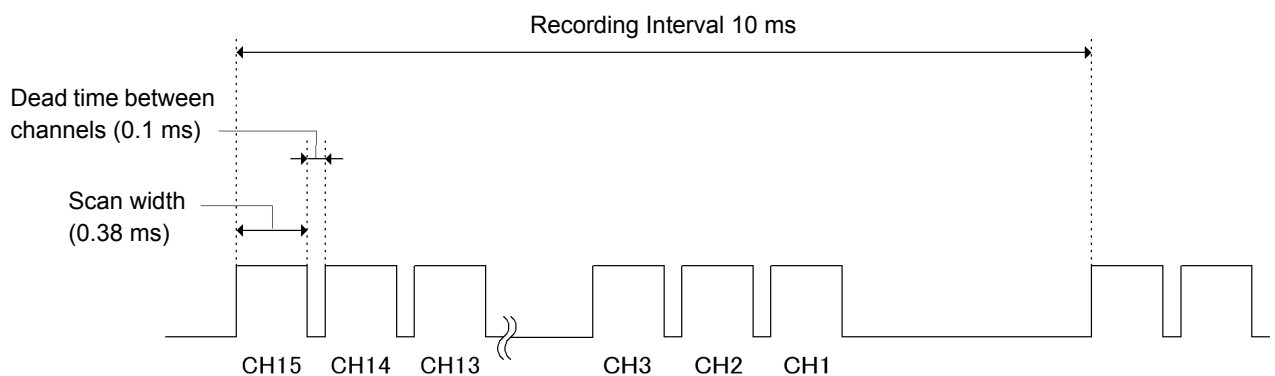

When the digital filter is off, the scan widths and dead times between channels are fixed to the values shown in the figure above regardless of the recording intervals. When the digital filter is on, the scan widths and dead times between channels vary in accordance with the recording intervals.

The following table show the scan widths and dead times between channels when the digital filter is on.

Recording Interval	Scan Widths	Dead Times between Channels
10 ms	0.38 ms	0.10 ms
20 ms	0.89 ms	0.11 ms
50 ms	2.37 ms	0.30 ms
100 ms	4.74 ms	0.59 ms
200 ms	9.39 ms	1.17 ms
500 ms	24.20 ms	3.02 ms
1 s	48.40 ms	6.05 ms
2 s	96.29 ms	12.04 ms
5 s, 10 s	50 Hz	160.00 ms ^{*1}
	60 Hz	133.33 ms ^{*2}
20 s or more	800.00 ms	100.00 ms

*1: 260.00 ms when in combination with humidity measurement.

*2: 266.67 ms when in combination with humidity measurement.

Appendix 2 Version Update

You can perform a key operation on the instrument to update the ROM and FPGA versions of the instrument.

1. Turn the power on while pressing **DISP** and then release the key when the model name and version appear in the display area. The instrument enters setting mode.

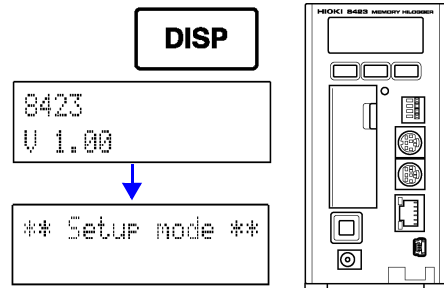

2. Press **START/MARK** multiple times until the following version update screen appears.

```
Version UP
DISP key: EXECUTE
```

3. Open the cover of the CF card slot, and fully insert a CF card containing the version update file. Place just one version update file in the root directory of the CF card. If there are 2 or more version updates, the version update will not be possible.
4. Close the cover, and confirm that the CF card access LED lights green.
5. Press **DISP** to start the version update. A version update takes approximately 4 minutes.
6. When the following version update end screen appears, turn the power off and then back on again.

```
FPGA COMPLETED
REBOOT
```

7. Eject the CF card from the card slot.

NOTE

- Be sure to close the cover after inserting a CF card. If the cover is not closed, the version update file cannot be read.
- Never turn the power off during a version update.
- For information on version update files, contact your dealer or Hioki representative.

Appendix 3 Error Display

If an error message or warning message appears, solve the problem as described in the corresponding solution below.

Appendix 3.1 Application Software

Error Messages

No.	Messages	Solution
1	An error occurred during measurement.	Check the status of the connection with the logger and the status of the computer.
2	An error occurred while accessing the file.	Check whether the media of the storage location or the file is damaged.
3	The specification for the save file location is incorrect.	Set the save location for files correctly on the measurement settings page of the settings screen.
4	The file could not be saved.	Check whether the media exists and the status of the media.
6	The file could not be read.	Check whether the file is damaged, and whether it is of a format supported by the instrument.
7	The media is access protected.	Check whether write-protection is set for the media.
8	There is insufficient remaining space on the media.	Delete any unnecessary files or use new media.
10	A protocol error occurred.	A communication protocol error has occurred. Check the power and connection status of the logger.
11	A timeout occurred.	A timeout error occurred during communication with the logger. Check the power and connection status of the logger.
23	Could not communicate with the logger.	Check whether the computer is connected to the logger properly.
26	The specified address destination is not the 8423.	A device other than the 8423 is connected at the specified address destination. Be sure to connect the 8423.
28	The address or serial No. is incorrect.	Check whether the address and serial No. of the logger are correct. The connection cable may also be disconnected.
29	The specified logger is measuring.	The operation cannot be continued because the specified logger is measuring. You can proceed with the operation if you stop measurement.
32	The synchronization cable is disconnected.	A 9683 Connection Cable (for synchronization) is disconnected. Check the connections.
33	Six or more loggers are connected to the synchronization chain.	Disconnect any unnecessary loggers from the synchronization chain.
34	There is an unregistered logger in the synchronization chain.	There is an unknown logger in the synchronization chain. Register the logger on the connection settings page in the settings dialog box.
35	The registered logger could not be found in the synchronization chain.	A logger registered on the connection settings page of the settings dialog box could not be found in the synchronization chain. Check the connection status or cancel the registration.
36	There is a logger with an incorrect unit configuration.	A logger with a unit configuration different from that of the registered loggers is connected. Match the unit configuration to the registered data, or cancel the registration and then reconfigure the settings.

A4

Appendix 3 Error Display

No.	Messages	Solution
37	There is a logger without a measurement channel.	Check the channel configuration of the connected loggers.
38	The measurement stop time has elapsed.	Set a measurement stop time that is later than the current time.
39	The recording period setting is incorrect.	The recording period is set to 0. Set the recording period to other than 0 or set continuous recording to ON.
40	The timer measurement setting is incorrect.	The same value is set for the start time and stop time. Change the value of one of them.

Warning Messages

No.	Messages	Solution
100	The application cannot be ended during measurement.	Stop measurement if you want to end the application.
103	The AB cursors cannot move to this position.	If cursors A and B are set to be moved at the same time, a cursor cannot be moved to a position which will result in the other cursor being outside the measurement data range. In such a case, cancel the setting for moving the cursors at the same time.
104	The maximum number of event marks is not set.	The maximum number of event marks is 1000. Delete unnecessary event marks.
105	The selected channel cannot be used.	The selected channel cannot be used for the corresponding function. Select another channel. (Example: An alarm channel cannot be specified as a gauge channel.)
500	Data that matched the search conditions could not be found.	Change the search conditions.

Appendix 3.2 8423 Memory HiLogger Main Unit

Messages that appear on the screen which are considered to be very important are referred to as error messages, and all other message are referred to as warning messages. An error message disappears if the cause of the error is resolved or **DISP** is pressed. A warning message disappears if the cause of the error is resolved, **DISP** is pressed, or 1 minute elapses.

Error Messages

No.	Messages	Meaning	Solution
10	Timer trig error	Measurement was not started because the timer stop time has already passed.	Change the timer stop time, or cancel the timer.
11	Sync. error.	The synchronization signal could not be sent or received normally.	Check the connections of the 9683 Connection Cables. Check whether a cable is disconnected. Check the power of the other devices connected by cable. Check the master/slave setting for synchronization of the other devices connected by cable.
12	Too many Modules	Too many units are attached to the instrument.	Attach no more than eight units to the instrument.
20	CF card error	The file management information of the CF card is damaged.	The CF card cannot be used as is because the file management information of the CF card is damaged. Eject the CF card you are using immediately, and then back up the data. Then, replace the CF card with a new formatted one.
21	Replace CF card	Replace the CF card of the instrument with a new one.	Replace the CF card with a new formatted one, because a CF card read/write error occurred or there is no longer sufficient space to write.
22	Card format Err	The instrument does not support the format type of the CF card.	See "3.6.1 Formatting a CF Card" (p. 45), and use a correctly formatted CF card.
23	Write Protected	Write protection is set for the CF card.	Cancel write protection.
24	Access error	Reading and writing of a file failed.	The CF card may be broken, or the file management information may be damaged. Replace the CF card with a new formatted one.
25	Unreadable card	The CF card cannot be used with the instrument.	Use a genuine CF card.
28	Directory full	There is insufficient space in the CF card, or no more files can be created in the current directory.	Replace the CF card with a new formatted one.
29	Check Card/Cover	No CF card is inserted, or the cover is open.	Insert a CF card and close the cover. If the message still appears when you insert the CF card and close the cover, replace the CF card with a new formatted one because it cannot be used.
31	File Error	A file could not be deleted with the delete and save function.	There is no file that can be deleted, or the file management information of the CF card is damaged. Replace the CF card with a new formatted one.
32	Disk full	There is insufficient space on the CF card to save the file.	Replace the CF card with a new formatted one.

A6

Appendix 3 Error Display

Warning Messages

When an error occurs, a message appears in the display area and **DISP** flashes red. The warning message disappears when **DISP** is pressed.

No.	Messages	Meaning	Solution
201	Can'tMoveDrtory	The data could not be moved to the directory used last time or the specified directory.	When saving data to a directory other than the standard \LOGGER directory, use a CF card on which that directory has already been created.
202	File locked	An attempt was made to write to a read-only file, or an attempt is being made to read/write from or to a file currently being used for another task.	Cancel the read-only attribute of the file, or wait until the other task is finished.
203	Read only file	The file cannot be modified or deleted because it is a read-only file.	Cancel the read-only attribute.
204	Bad path or name	There is an error with the path name or file name.	Use the correct path name or file name.
205	Same File exists	A file of the same name exists.	Change the file name.
207	Path too long	The path name is too long.	Make sure the path name is no more than 127 characters long.
208	Set CardDir Name	There was no name when attempting to create a directory.	Specify the directory name.
209	Same Dir. Exists	A directory of the same name exists.	Change the directory name.
212	Bad file data	An attempt was made to read a file of a different format.	If the file was saved by an instrument of a version newer than that of the instrument, update the version of the instrument. This message also appears if an attempt is made to read a damaged file or a file of another format.
213	program file err	The file for updating the version could not be found.	Make sure there is only one 8423 version update file in the root directory of the CF card.
214	setup file err	The file for setting the instrument could not be found.	Make sure there is only one 8423 settings file in the root directory of the CF card.
226	Card Almost full	There is insufficient space on the CF card.	This message appears when the available space is 10% or less, or 16 MB or less. Replace the CF card with a new formatted one if necessary.
227	Old file deleted	An old file was deleted with the delete and save function.	An old file was deleted because the delete and save setting is set. Replace the CF card with a new formatted one if necessary.
303	No wave data	There is no waveform data in the memory of the instrument.	Start measurement so that the instrument can obtain waveform data.
520	Bad MAC address	The MAC address of the instrument has been altered.	Contact your dealer or Hioki representative.
521	Bad IP address	The IP address is invalid.	Check the IP address setting.
527	Comm. Error	A communication error occurred.	Check the communication settings of the instrument, communication cable, communication circuit, and communication destination.
529	DHCP failure	An IP address could not be obtained with DHCP.	Check the communication settings of the instrument, communication cable, communication circuit, and DHCP server.

Appendix 4 Recording Intervals and Maximum Times for Recording to CF Cards

The following shows the maximum recording period when saving waveform files of channels of the 8948 Voltage/Temp Unit, 8949 Universal Unit, 8996 Digital/Pulse Unit (input type: logic), and 8997 Alarm Unit.

NOTE

- Estimate recording periods to be about 90% of those indicated on the following pages, because the actual size of a CF card is less than that written on it, and the header of the waveform file was not included in the calculation.
- There is no indication when the total number of days exceeds 365 days.

Appendix 4.1 Model 9726 PC Card 128M

When saving waveform files of the 8948 Voltage/Temp Unit, 8949 Universal Unit, 8996 Digital/Pulse Unit (input type: logic), and 8997 Alarm Unit:

(d: days/ h: hours/ min: minutes)

Used CH	Recording Interval					
	10ms	20ms	50ms	100ms	200ms	500ms
1	7d 18h 24min	15d 12h 49min	38d 20h 04min	77d 16h 08min	155d 08h 16min	
2	3d 21h 12min	7d 18h 24min	19d 10h 02min	38d 20h 04min	77d 16h 08min	194d 04h 20min
3	2d 14h 08min	5d 04h 16min	12d 22h 41min	25d 21h 22min	51d 18h 45min	129d 10h 53min
4	1d 22h 36min	3d 21h 12min	9d 17h 01min	19d 10h 02min	38d 20h 04min	97d 02h 10min
5	1d 13h 16min	3d 02h 33min	7d 18h 24min	15d 12h 49min	31d 01h 39min	77d 16h 08min
6	1d 07h 04min	2d 14h 08min	6d 11h 20min	12d 22h 41min	25d 21h 22min	64d 17h 26min
7	1d 02h 37min	2d 05h 15min	5d 13h 09min	11d 02h 18min	22d 04h 36min	55d 11h 31min
8	0d 23h 18min	1d 22h 36min	4d 20h 30min	9d 17h 01min	19d 10h 02min	48d 13h 05min
9	0d 20h 42min	1d 17h 25min	4d 07h 33min	8d 15h 07min	17d 06h 15min	43d 03h 37min
10	0d 18h 38min	1d 13h 16min	3d 21h 12min	7d 18h 24min	15d 12h 49min	38d 20h 04min
11	0d 16h 56min	1d 09h 53min	3d 12h 44min	7d 01h 28min	14d 02h 56min	35d 07h 20min
12	0d 15h 32min	1d 07h 04min	3d 05h 40min	6d 11h 20min	12d 22h 41min	32d 08h 43min
13	0d 14h 20min	1d 04h 40min	2d 23h 41min	5d 23h 23min	11d 22h 47min	29d 20h 58min
14	0d 13h 18min	1d 02h 37min	2d 18h 34min	5d 13h 09min	11d 02h 18min	27d 17h 45min
15	0d 12h 25min	1d 0h 51min	2d 14h 08min	5d 04h 16min	10d 08h 33min	25d 21h 22min
30	0d 06h 12min	0d 12h 25min	1d 07h 04min	2d 14h 08min	5d 04h 16min	12d 22h 41min
45	0d 04h 08min	0d 08h 17min	0d 20h 42min	1d 17h 25min	3d 10h 51min	8d 15h 07min
60	0d 03h 06min	0d 06h 12min	0d 15h 32min	1d 07h 04min	2d 14h 08min	6d 11h 20min
75	0d 02h 29min	0d 04h 58min	0d 12h 25min	1d 0h 51min	2d 01h 42min	5d 04h 16min
90	0d 02h 04min	0d 04h 08min	0d 10h 21min	0d 20h 42min	1d 17h 25min	4d 07h 33min
105	0d 01h 46min	0d 03h 33min	0d 08h 52min	0d 17h 45min	1d 11h 30min	3d 16h 46min
120	0d 01h 33min	0d 03h 06min	0d 07h 46min	0d 15h 32min	1d 07h 04min	3d 05h 40min

Used CH	Recording Interval				
	1s	10s	1min	10min	1hour
1					
2					
3	258d 21h 47min				
4	194d 04h 20min				
5	155d 08h 16min				
6	129d 10h 53min				
7	110d 23h 03min				
8	97d 02h 10min				
9	86d 07h 15min				
10	77d 16h 08min				
11	70d 14h 40min				
12	64d 17h 26min				
13	59d 17h 57min				
14	55d 11h 31min				
15	51d 18h 45min				
30	25d 21h 22min	258d 21h 47min			
45	17d 06h 15min	172d 14h 31min			
60	12d 22h 41min	129d 10h 53min			
75	10d 08h 33min	103d 13h 30min			
90	8d 15h 07min	86d 07h 15min			
105	7d 09h 32min	73d 23h 22min			
120	6d 11h 20min	64d 17h 26min			

Appendix 4 Recording Intervals and Maximum Times for Recording to CF Cards

When saving waveform files of the 8996 Digital/Pulse Unit (input type: pulse):

Used CH	Recording Interval					
	10ms	20ms	50ms	100ms	200ms	500ms
1	3d 21h 12min	7d 18h 24min	19d 10h 02min	38d 20h 04min	77d 16h 08min	194d 04h 20min
2	1d 22h 36min	3d 21h 12min	9d 17h 01min	19d 10h 02min	38d 20h 04min	97d 02h 10min
3	1d 07h 04min	2d 14h 08min	6d 11h 20min	12d 22h 41min	25d 21h 22min	64d 17h 26min
4	0d 23h 18min	1d 22h 36min	4d 20h 30min	9d 17h 01min	19d 10h 02min	48d 13h 05min
5	0d 18h 38min	1d 13h 16min	3d 21h 12min	7d 18h 24min	15d 12h 49min	38d 20h 04min
6	0d 15h 32min	1d 07h 04min	3d 05h 40min	6d 11h 20min	12d 22h 41min	32d 08h 43min
7	0d 13h 18min	1d 02h 37min	2d 18h 34min	5d 13h 09min	11d 02h 18min	27d 17h 45min
8	0d 11h 39min	0d 23h 18min	2d 10h 15min	4d 20h 30min	9d 17h 01min	24d 06h 32min
9	0d 10h 21min	0d 20h 42min	2d 03h 46min	4d 07h 33min	8d 15h 07min	21d 13h 48min
10	0d 09h 19min	0d 18h 38min	1d 22h 36min	3d 21h 12min	7d 18h 24min	19d 10h 02min
11	0d 08h 28min	0d 16h 56min	1d 18h 22min	3d 12h 44min	7d 01h 28min	17d 15h 40min
12	0d 07h 46min	0d 15h 32min	1d 14h 50min	3d 05h 40min	6d 11h 20min	16d 04h 21min
13	0d 07h 10min	0d 14h 20min	1d 11h 50min	2d 23h 41min	5d 23h 23min	14d 22h 29min
14	0d 06h 39min	0d 13h 18min	1d 09h 17min	2d 18h 34min	5d 13h 09min	13d 20h 52min
15	0d 06h 12min	0d 12h 25min	1d 07h 04min	2d 14h 08min	5d 04h 16min	12d 22h 41min
30	0d 03h 06min	0d 06h 12min	0d 15h 32min	1d 07h 04min	2d 14h 08min	6d 11h 20min
45	0d 02h 04min	0d 04h 08min	0d 10h 21min	0d 20h 42min	1d 17h 25min	4d 07h 33min
60	0d 01h 33min	0d 03h 06min	0d 07h 46min	0d 15h 32min	1d 07h 04min	3d 05h 40min
75	0d 01h 14min	0d 02h 29min	0d 06h 12min	0d 12h 25min	1d 0h 51min	2d 14h 08min
90	0d 01h 02min	0d 02h 04min	0d 05h 10min	0d 10h 21min	0d 20h 42min	2d 03h 46min
105	0d 0h 53min	0d 01h 46min	0d 04h 26min	0d 08h 52min	0d 17h 45min	1d 20h 23min
120	0d 0h 46min	0d 01h 33min	0d 03h 53min	0d 07h 46min	0d 15h 32min	1d 14h 50min

Used CH	Recording Interval				
	1s	10s	1min	10min	1hour
1					
2	194d 04h 20min				
3	129d 10h 53min				
4	97d 02h 10min				
5	77d 16h 08min				
6	64d 17h 26min				
7	55d 11h 31min				
8	48d 13h 05min				
9	43d 03h 37min				
10	38d 20h 04min				
11	35d 07h 20min	353d 01h 20min			
12	32d 08h 43min	323d 15h 13min			
13	29d 20h 58min	298d 17h 45min			
14	27d 17h 45min	277d 09h 37min			
15	25d 21h 22min	258d 21h 47min			
30	12d 22h 41min	129d 10h 53min			
45	8d 15h 07min	86d 07h 15min			
60	6d 11h 20min	64d 17h 26min			
75	5d 04h 16min	51d 18h 45min	310d 16h 32min		
90	4d 07h 33min	43d 03h 37min	258d 21h 47min		
105	3d 16h 46min	36d 23h 41min	221d 22h 06min		
120	3d 05h 40min	32d 08h 43min	194d 04h 20min		

A10

Appendix 4 Recording Intervals and Maximum Times for Recording to CF Cards

Appendix 4.2 Model 9727 PC Card 256M

When saving waveform files of the 8948 Voltage/Temp Unit, 8949 Universal Unit, 8996 Digital/Pulse Unit (input type: logic), and 8997 Alarm Unit:

(d: days/ h: hours/ min: minutes)

Used CH	Recording Interval					
	10ms	20ms	50ms	100ms	200ms	500ms
1	15d 12h 49min	31d 01h 39min	77d 16h 08min	155d 08h 16min	310d 16h 32min	
2	7d 18h 24min	15d 12h 49min	38d 20h 04min	77d 16h 08min	155d 08h 16min	
3	5d 04h 16min	10d 08h 33min	25d 21h 22min	51d 18h 45min	103d 13h 30min	258d 21h 47min
4	3d 21h 12min	7d 18h 24min	19d 10h 02min	38d 20h 04min	77d 16h 08min	194d 04h 20min
5	3d 02h 33min	6d 05h 07min	15d 12h 49min	31d 01h 39min	62d 03h 18min	155d 08h 16min
6	2d 14h 08min	5d 04h 16min	12d 22h 41min	25d 21h 22min	51d 18h 45min	129d 10h 53min
7	2d 05h 15min	4d 10h 31min	11d 02h 18min	22d 04h 36min	44d 09h 13min	110d 23h 03min
8	1d 22h 36min	3d 21h 12min	9d 17h 01min	19d 10h 02min	38d 20h 04min	97d 02h 10min
9	1d 17h 25min	3d 10h 51min	8d 15h 07min	17d 06h 15min	34d 12h 30min	86d 07h 15min
10	1d 13h 16min	3d 02h 33min	7d 18h 24min	15d 12h 49min	31d 01h 39min	77d 16h 08min
11	1d 09h 53min	2d 19h 47min	7d 01h 28min	14d 02h 56min	28d 05h 52min	70d 14h 40min
12	1d 07h 04min	2d 14h 08min	6d 11h 20min	12d 22h 41min	25d 21h 22min	64d 17h 26min
13	1d 04h 40min	2d 09h 21min	5d 23h 23min	11d 22h 47min	23d 21h 34min	59d 17h 57min
14	1d 02h 37min	2d 05h 15min	5d 13h 09min	11d 02h 18min	22d 04h 36min	55d 11h 31min
15	1d 0h 51min	2d 01h 42min	5d 04h 16min	10d 08h 33min	20d 17h 06min	51d 18h 45min
30	0d 12h 25min	1d 0h 51min	2d 14h 08min	5d 04h 16min	10d 08h 33min	25d 21h 22min
45	0d 08h 17min	0d 16h 34min	1d 17h 25min	3d 10h 51min	6d 21h 42min	17d 06h 15min
60	0d 06h 12min	0d 12h 25min	1d 07h 04min	2d 14h 08min	5d 04h 16min	12d 22h 41min
75	0d 04h 58min	0d 09h 56min	1d 0h 51min	2d 01h 42min	4d 03h 25min	10d 08h 33min
90	0d 04h 08min	0d 08h 17min	0d 20h 42min	1d 17h 25min	3d 10h 51min	8d 15h 07min
105	0d 03h 33min	0d 07h 06min	0d 17h 45min	1d 11h 30min	2d 23h 0min	7d 09h 32min
120	0d 03h 06min	0d 06h 12min	0d 15h 32min	1d 07h 04min	2d 14h 08min	6d 11h 20min

Used CH	Recording Interval				
	1s	10s	1min	10min	1hour
1					
2					
3					
4					
5	310d 16h 32min				
6	258d 21h 47min				
7	221d 22h 06min				
8	194d 04h 20min				
9	172d 14h 31min				
10	155d 08h 16min				
11	141d 05h 20min				
12	129d 10h 53min				
13	119d 11h 54min				
14	110d 23h 03min				
15	103d 13h 30min				
30	51d 18h 45min				
45	34d 12h 30min	345d 05h 02min			
60	25d 21h 22min	258d 21h 47min			
75	20d 17h 06min	207d 03h 01min			
90	17d 06h 15min	172d 14h 31min			
105	14d 19h 04min	147d 22h 44min			
120	12d 22h 41min	129d 10h 53min			

Appendix 4 Recording Intervals and Maximum Times for Recording to CF Cards

When saving waveform files of the 8996 Digital/Pulse Unit (input type: pulse):

Used CH	Recording Interval					
	10ms	20ms	50ms	100ms	200ms	500ms
1	7d 18h 24min	15d 12h 49min	38d 20h 04min	77d 16h 08min	155d 08h 16min	
2	3d 21h 12min	7d 18h 24min	19d 10h 02min	38d 20h 04min	77d 16h 08min	194d 04h 20min
3	2d 14h 08min	5d 04h 16min	12d 22h 41min	25d 21h 22min	51d 18h 45min	129d 10h 53min
4	1d 22h 36min	3d 21h 12min	9d 17h 01min	19d 10h 02min	38d 20h 04min	97d 02h 10min
5	1d 13h 16min	3d 02h 33min	7d 18h 24min	15d 12h 49min	31d 01h 39min	77d 16h 08min
6	1d 07h 04min	2d 14h 08min	6d 11h 20min	12d 22h 41min	25d 21h 22min	64d 17h 26min
7	1d 02h 37min	2d 05h 15min	5d 13h 09min	11d 02h 18min	22d 04h 36min	55d 11h 31min
8	0d 23h 18min	1d 22h 36min	4d 20h 30min	9d 17h 01min	19d 10h 02min	48d 13h 05min
9	0d 20h 42min	1d 17h 25min	4d 07h 33min	8d 15h 07min	17d 06h 15min	43d 03h 37min
10	0d 18h 38min	1d 13h 16min	3d 21h 12min	7d 18h 24min	15d 12h 49min	38d 20h 04min
11	0d 16h 56min	1d 09h 53min	3d 12h 44min	7d 01h 28min	14d 02h 56min	35d 07h 20min
12	0d 15h 32min	1d 07h 04min	3d 05h 40min	6d 11h 20min	12d 22h 41min	32d 08h 43min
13	0d 14h 20min	1d 04h 40min	2d 23h 41min	5d 23h 23min	11d 22h 47min	29d 20h 58min
14	0d 13h 18min	1d 02h 37min	2d 18h 34min	5d 13h 09min	11d 02h 18min	27d 17h 45min
15	0d 12h 25min	1d 0h 51min	2d 14h 08min	5d 04h 16min	10d 08h 33min	25d 21h 22min
30	0d 06h 12min	0d 12h 25min	1d 07h 04min	2d 14h 08min	5d 04h 16min	12d 22h 41min
45	0d 04h 08min	0d 08h 17min	0d 20h 42min	1d 17h 25min	3d 10h 51min	8d 15h 07min
60	0d 03h 06min	0d 06h 12min	0d 15h 32min	1d 07h 04min	2d 14h 08min	6d 11h 20min
75	0d 02h 29min	0d 04h 58min	0d 12h 25min	1d 0h 51min	2d 01h 42min	5d 04h 16min
90	0d 02h 04min	0d 04h 08min	0d 10h 21min	0d 20h 42min	1d 17h 25min	4d 07h 33min
105	0d 01h 46min	0d 03h 33min	0d 08h 52min	0d 17h 45min	1d 11h 30min	3d 16h 46min
120	0d 01h 33min	0d 03h 06min	0d 07h 46min	0d 15h 32min	1d 07h 04min	3d 05h 40min

Used CH	Recording Interval				
	1s	10s	1min	10min	1hour
1					
2					
3	258d 21h 47min				
4	194d 04h 20min				
5	155d 08h 16min				
6	129d 10h 53min				
7	110d 23h 03min				
8	97d 02h 10min				
9	86d 07h 15min				
10	77d 16h 08min				
11	70d 14h 40min				
12	64d 17h 26min				
13	59d 17h 57min				
14	55d 11h 31min				
15	51d 18h 45min				
30	25d 21h 22min	258d 21h 47min			
45	17d 06h 15min	172d 14h 31min			
60	12d 22h 41min	129d 10h 53min			
75	10d 08h 33min	103d 13h 30min			
90	8d 15h 07min	86d 07h 15min			
105	7d 09h 32min	73d 23h 22min			
120	6d 11h 20min	64d 17h 26min			

A12

Appendix 4 Recording Intervals and Maximum Times for Recording to CF Cards

Appendix 4.3 Model 9728 PC Card 512M

When saving waveform files of the 8948 Voltage/Temp Unit, 8949 Universal Unit, 8996 Digital/Pulse Unit (input type: logic), and 8997 Alarm Unit:

(d: days/ h: hours/ min: minutes)

Used CH	Recording Interval					
	10ms	20ms	50ms	100ms	200ms	500ms
1	31d 01h 39min	62d 03h 18min	155d 08h 16min	310d 16h 32min		
2	15d 12h 49min	31d 01h 39min	77d 16h 08min	155d 08h 16min	310d 16h 32min	
3	10d 08h 33min	20d 17h 06min	51d 18h 45min	103d 13h 30min	207d 03h 01min	
4	7d 18h 24min	15d 12h 49min	38d 20h 04min	77d 16h 08min	155d 08h 16min	
5	6d 05h 07min	12d 10h 15min	31d 01h 39min	62d 03h 18min	124d 06h 36min	310d 16h 32min
6	5d 04h 16min	10d 08h 33min	25d 21h 22min	51d 18h 45min	103d 13h 30min	258d 21h 47min
7	4d 10h 31min	8d 21h 02min	22d 04h 36min	44d 09h 13min	88d 18h 26min	221d 22h 06min
8	3d 21h 12min	7d 18h 24min	19d 10h 02min	38d 20h 04min	77d 16h 08min	194d 04h 20min
9	3d 10h 51min	6d 21h 42min	17d 06h 15min	34d 12h 30min	69d 01h 0min	172d 14h 31min
10	3d 02h 33min	6d 05h 07min	15d 12h 49min	31d 01h 39min	62d 03h 18min	155d 08h 16min
11	2d 19h 47min	5d 15h 34min	14d 02h 56min	28d 05h 52min	56d 11h 44min	141d 05h 20min
12	2d 14h 08min	5d 04h 16min	12d 22h 41min	25d 21h 22min	51d 18h 45min	129d 10h 53min
13	2d 09h 21min	4d 18h 42min	11d 22h 47min	23d 21h 34min	47d 19h 09min	119d 11h 54min
14	2d 05h 15min	4d 10h 31min	11d 02h 18min	22d 04h 36min	44d 09h 13min	110d 23h 03min
15	2d 01h 42min	4d 03h 25min	10d 08h 33min	20d 17h 06min	41d 10h 12min	103d 13h 30min
30	1d 0h 51min	2d 01h 42min	5d 04h 16min	10d 08h 33min	20d 17h 06min	51d 18h 45min
45	0d 16h 34min	1d 09h 08min	3d 10h 51min	6d 21h 42min	13d 19h 24min	34d 12h 30min
60	0d 12h 25min	1d 0h 51min	2d 14h 08min	5d 04h 16min	10d 08h 33min	25d 21h 22min
75	0d 09h 56min	0d 19h 53min	2d 01h 42min	4d 03h 25min	8d 06h 50min	20d 17h 06min
90	0d 08h 17min	0d 16h 34min	1d 17h 25min	3d 10h 51min	6d 21h 42min	17d 06h 15min
105	0d 07h 06min	0d 14h 12min	1d 11h 30min	2d 23h 0min	5d 22h 01min	14d 19h 04min
120	0d 06h 12min	0d 12h 25min	1d 07h 04min	2d 14h 08min	5d 04h 16min	12d 22h 41min

Used CH	Recording Interval				
	1s	10s	1min	10min	1hour
1					
2					
3					
4					
5					
6					
7					
8					
9	345d 05h 02min				
10	310d 16h 32min				
11	282d 10h 40min				
12	258d 21h 47min				
13	238d 23h 48min				
14	221d 22h 06min				
15	207d 03h 01min				
30	103d 13h 30min				
45	69d 01h 0min				
60	51d 18h 45min				
75	41d 10h 12min				
90	34d 12h 30min	345d 05h 02min			
105	29d 14h 08min	295d 21h 28min			
120	25d 21h 22min	258d 21h 47min			

Appendix 4 Recording Intervals and Maximum Times for Recording to CF Cards

When saving waveform files of the 8996 Digital/Pulse Unit (input type: pulse):

Used CH	Recording Interval					
	10ms	20ms	50ms	100ms	200ms	500ms
1	15d 12h 49min	31d 01h 39min	77d 16h 08min	155d 08h 16min	310d 16h 32min	
2	7d 18h 24min	15d 12h 49min	38d 20h 04min	77d 16h 08min	155d 08h 16min	
3	5d 04h 16min	10d 08h 33min	25d 21h 22min	51d 18h 45min	103d 13h 30min	258d 21h 47min
4	3d 21h 12min	7d 18h 24min	19d 10h 02min	38d 20h 04min	77d 16h 08min	194d 04h 20min
5	3d 02h 33min	6d 05h 07min	15d 12h 49min	31d 01h 39min	62d 03h 18min	155d 08h 16min
6	2d 14h 08min	5d 04h 16min	12d 22h 41min	25d 21h 22min	51d 18h 45min	129d 10h 53min
7	2d 05h 15min	4d 10h 31min	11d 02h 18min	22d 04h 36min	44d 09h 13min	110d 23h 03min
8	1d 22h 36min	3d 21h 12min	9d 17h 01min	19d 10h 02min	38d 20h 04min	97d 02h 10min
9	1d 17h 25min	3d 10h 51min	8d 15h 07min	17d 06h 15min	34d 12h 30min	86d 07h 15min
10	1d 13h 16min	3d 02h 33min	7d 18h 24min	15d 12h 49min	31d 01h 39min	77d 16h 08min
11	1d 09h 53min	2d 19h 47min	7d 01h 28min	14d 02h 56min	28d 05h 52min	70d 14h 40min
12	1d 07h 04min	2d 14h 08min	6d 11h 20min	12d 22h 41min	25d 21h 22min	64d 17h 26min
13	1d 04h 40min	2d 09h 21min	5d 23h 23min	11d 22h 47min	23d 21h 34min	59d 17h 57min
14	1d 02h 37min	2d 05h 15min	5d 13h 09min	11d 02h 18min	22d 04h 36min	55d 11h 31min
15	1d 0h 51min	2d 01h 42min	5d 04h 16min	10d 08h 33min	20d 17h 06min	51d 18h 45min
30	0d 12h 25min	1d 0h 51min	2d 14h 08min	5d 04h 16min	10d 08h 33min	25d 21h 22min
45	0d 08h 17min	0d 16h 34min	1d 17h 25min	3d 10h 51min	6d 21h 42min	17d 06h 15min
60	0d 06h 12min	0d 12h 25min	1d 07h 04min	2d 14h 08min	5d 04h 16min	12d 22h 41min
75	0d 04h 58min	0d 09h 56min	1d 0h 51min	2d 01h 42min	4d 03h 25min	10d 08h 33min
90	0d 04h 08min	0d 08h 17min	0d 20h 42min	1d 17h 25min	3d 10h 51min	8d 15h 07min
105	0d 03h 33min	0d 07h 06min	0d 17h 45min	1d 11h 30min	2d 23h 0min	7d 09h 32min
120	0d 03h 06min	0d 06h 12min	0d 15h 32min	1d 07h 04min	2d 14h 08min	6d 11h 20min

Used CH	Recording Interval				
	1s	10s	1min	10min	1hour
1					
2					
3					
4					
5	310d 16h 32min				
6	258d 21h 47min				
7	221d 22h 06min				
8	194d 04h 20min				
9	172d 14h 31min				
10	155d 08h 16min				
11	141d 05h 20min				
12	129d 10h 53min				
13	119d 11h 54min				
14	110d 23h 03min				
15	103d 13h 30min				
30	51d 18h 45min				
45	34d 12h 30min	345d 05h 02min			
60	25d 21h 22min	258d 21h 47min			
75	20d 17h 06min	207d 03h 01min			
90	17d 06h 15min	172d 14h 31min			
105	14d 19h 04min	147d 22h 44min			
120	12d 22h 41min	129d 10h 53min			

A14

Appendix 4 Recording Intervals and Maximum Times for Recording to CF Cards

Appendix 4.4 Model 9729 PC Card 1G

When saving waveform files of the 8948 Voltage/Temp Unit, 8949 Universal Unit, 8996 Digital/Pulse Unit (input type: logic), and 8997 Alarm Unit:

(d: days/ h: hours/ min: minutes)

Used CH	Recording Interval					
	10ms	20ms	50ms	100ms	200ms	500ms
1	62d 03h 18min	124d 06h 36min	310d 16h 32min			
2	31d 01h 39min	62d 03h 18min	155d 08h 16min	310d 16h 32min		
3	20d 17h 06min	41d 10h 12min	103d 13h 30min	207d 03h 01min		
4	15d 12h 49min	31d 01h 39min	77d 16h 08min	155d 08h 16min	310d 16h 32min	
5	12d 10h 15min	24d 20h 31min	62d 03h 18min	124d 06h 36min	248d 13h 13min	
6	10d 08h 33min	20d 17h 06min	51d 18h 45min	103d 13h 30min	207d 03h 01min	
7	8d 21h 02min	17d 18h 05min	44d 09h 13min	88d 18h 26min	177d 12h 52min	
8	7d 18h 24min	15d 12h 49min	38d 20h 04min	77d 16h 08min	155d 08h 16min	
9	6d 21h 42min	13d 19h 24min	34d 12h 30min	69d 01h 0min	138d 02h 01min	345d 05h 02min
10	6d 05h 07min	12d 10h 15min	31d 01h 39min	62d 03h 18min	124d 06h 36min	310d 16h 32min
11	5d 15h 34min	11d 07h 08min	28d 05h 52min	56d 11h 44min	112d 23h 28min	282d 10h 40min
12	5d 04h 16min	10d 08h 33min	25d 21h 22min	51d 18h 45min	103d 13h 30min	258d 21h 47min
13	4d 18h 42min	9d 13h 25min	23d 21h 34min	47d 19h 09min	95d 14h 19min	238d 23h 48min
14	4d 10h 31min	8d 21h 02min	22d 04h 36min	44d 09h 13min	88d 18h 26min	221d 22h 06min
15	4d 03h 25min	8d 06h 50min	20d 17h 06min	41d 10h 12min	82d 20h 24min	207d 03h 01min
30	2d 01h 42min	4d 03h 25min	10d 08h 33min	20d 17h 06min	41d 10h 12min	103d 13h 30min
45	1d 09h 08min	2d 18h 16min	6d 21h 42min	13d 19h 24min	27d 14h 48min	69d 01h 0min
60	1d 0h 51min	2d 01h 42min	5d 04h 16min	10d 08h 33min	20d 17h 06min	51d 18h 45min
75	0d 19h 53min	1d 15h 46min	4d 03h 25min	8d 06h 50min	16d 13h 40min	41d 10h 12min
90	0d 16h 34min	1d 09h 08min	3d 10h 51min	6d 21h 42min	13d 19h 24min	34d 12h 30min
105	0d 14h 12min	1d 04h 24min	2d 23h 0min	5d 22h 01min	11d 20h 03min	29d 14h 08min
120	0d 12h 25min	1d 0h 51min	2d 14h 08min	5d 04h 16min	10d 08h 33min	25d 21h 22min

Used CH	Recording Interval				
	1s	10s	1min	10min	1hour
1					
2					
3					
4					
5					
6					
7					
8					
9					
10					
11					
12					
13					
14					
15					
30	207d 03h 01min				
45	138d 02h 01min				
60	103d 13h 30min				
75	82d 20h 24min				
90	69d 01h 0min				
105	59d 04h 17min				
120	51d 18h 45min				

Appendix 4 Recording Intervals and Maximum Times for Recording to CF Cards

When saving waveform files of the 8996 Digital/Pulse Unit (input type: pulse):

Used CH	Recording Interval					
	10ms	20ms	50ms	100ms	200ms	500ms
1	31d 01h 39min	62d 03h 18min	155d 08h 16min	310d 16h 32min		
2	15d 12h 49min	31d 01h 39min	77d 16h 08min	155d 08h 16min	310d 16h 32min	
3	10d 08h 33min	20d 17h 06min	51d 18h 45min	103d 13h 30min	207d 03h 01min	
4	7d 18h 24min	15d 12h 49min	38d 20h 04min	77d 16h 08min	155d 08h 16min	
5	6d 05h 07min	12d 10h 15min	31d 01h 39min	62d 03h 18min	124d 06h 36min	310d 16h 32min
6	5d 04h 16min	10d 08h 33min	25d 21h 22min	51d 18h 45min	103d 13h 30min	258d 21h 47min
7	4d 10h 31min	8d 21h 02min	22d 04h 36min	44d 09h 13min	88d 18h 26min	221d 22h 06min
8	3d 21h 12min	7d 18h 24min	19d 10h 02min	38d 20h 04min	77d 16h 08min	194d 04h 20min
9	3d 10h 51min	6d 21h 42min	17d 06h 15min	34d 12h 30min	69d 01h 0min	172d 14h 31min
10	3d 02h 33min	6d 05h 07min	15d 12h 49min	31d 01h 39min	62d 03h 18min	155d 08h 16min
11	2d 19h 47min	5d 15h 34min	14d 02h 56min	28d 05h 52min	56d 11h 44min	141d 05h 20min
12	2d 14h 08min	5d 04h 16min	12d 22h 41min	25d 21h 22min	51d 18h 45min	129d 10h 53min
13	2d 09h 21min	4d 18h 42min	11d 22h 47min	23d 21h 34min	47d 19h 09min	119d 11h 54min
14	2d 05h 15min	4d 10h 31min	11d 02h 18min	22d 04h 36min	44d 09h 13min	110d 23h 03min
15	2d 01h 42min	4d 03h 25min	10d 08h 33min	20d 17h 06min	41d 10h 12min	103d 13h 30min
30	1d 0h 51min	2d 01h 42min	5d 04h 16min	10d 08h 33min	20d 17h 06min	51d 18h 45min
45	0d 16h 34min	1d 09h 08min	3d 10h 51min	6d 21h 42min	13d 19h 24min	34d 12h 30min
60	0d 12h 25min	1d 0h 51min	2d 14h 08min	5d 04h 16min	10d 08h 33min	25d 21h 22min
75	0d 09h 56min	0d 19h 53min	2d 01h 42min	4d 03h 25min	8d 06h 50min	20d 17h 06min
90	0d 08h 17min	0d 16h 34min	1d 17h 25min	3d 10h 51min	6d 21h 42min	17d 06h 15min
105	0d 07h 06min	0d 14h 12min	1d 11h 30min	2d 23h 0min	5d 22h 01min	14d 19h 04min
120	0d 06h 12min	0d 12h 25min	1d 07h 04min	2d 14h 08min	5d 04h 16min	12d 22h 41min

Used CH	Recording Interval				
	1s	10s	1min	10min	1hour
1					
2					
3					
4					
5					
6					
7					
8					
9	345d 05h 02min				
10	310d 16h 32min				
11	282d 10h 40min				
12	258d 21h 47min				
13	238d 23h 48min				
14	221d 22h 06min				
15	207d 03h 01min				
30	103d 13h 30min				
45	69d 01h 0min				
60	51d 18h 45min				
75	41d 10h 12min				
90	34d 12h 30min	345d 05h 02min			
105	29d 14h 08min	295d 21h 28min			
120	25d 21h 22min	258d 21h 47min			

A16

Appendix 4 Recording Intervals and Maximum Times for Recording to CF Cards

Index

Symbols

.CSV	164
.LUI	163
.LUV	163
.LUW	163
.MEM	163
.TXT	164

Numerics

100BASE-TX connector	12, 44
3-wire	38, 92
4-wire	38, 92
50 Hz	75
60 Hz	75

A

Absolute time	149
AC adapter	12, 42
Accuracy	5
Accuracy guarantee for temperature and humidity	216
Address	69
Alarm channel	118
Alarm function	118
Alarm output	38
Alarm position	157
Analog trigger	114
AND	105, 112, 117
Area	151, 152
Assigning channels to sheets	103
Auto save mode	83
Average	151, 152

B

Backup battery	215
Backup RAM	198
Between A and B	150, 155
Binary	123
Burn out detection	91
BUS check	199

C

Calculation expressions	152
Calculations	150

Calibration	234
CF card	12, 46
CF card access LED	46
CF card slot	12
CH marker	144
Channel indication	61
Channel list	159
Channel number	61
Chattering prevention filter	93
Comment	69, 89
Comment display	149
Comment input	84
Communication cable	43
Communication setting items	68
Communications	209
Computer based measurement	16, 135
Connection fittings	33
Continuous recording	86
Copy	128
Count mode	93
Cursor	141
Cursors A and B	141
Cutoff frequency	222, 225

D

Data timer for saving	86
Date	188
Dead time	A1
Delete and Save	123
Detection edge	121
DHCP	69, 190
Digital filter	75
Dimension diagrams	228
DIN rail	6, 41
DISP key	13
Display channels	13, 159
Display content	148
Display file	163
Display format for time values	149
Display grid	144
Display interval	148
Display language	196
Display lower limit	140
Display settings windows	53, 60
Display type	148
Display upper limit	140
Displayed waveform	146

Index 2

Index

DNS 70
Dual sampling 10, 78

E

Ejecting a CF card 46
Environment conditions 121
Error display A3
Error message 13, A3
Event mark 153
External control input terminals 12, 50, 121
External sampling 81
External trigger 113, 217

F

f.s. 5
Ferrite clamp 44
File Full 123
File menu 54
File protection 47
File save settings 82
Format a CF card 45
FPGA version 204, A2
FTP 213
Full reset 233
Function 77

G

Gateway 69, 194
Gauge display 145
GND 50, 122

H

Help menu 54
High-speed sampling 79
Host name 71
HTTP/FTP 209
HUB 72
Humidity 92
Humidity measurement 38

I

IN/OUT 116
Index file 163
Input cable 37
Input type 89
Inserting a CF card 46
Install 16, 17
Installation 40
Integral 151
Interface 69
Internal format 166, 198

IP address 16, 69, 73, 191

K

Key check 200
Key operations 13

L

LAN cable 44, 73
LAN communication 16
LAN connection 71
LCD check 202
LED check 201
Level 157
Level trigger 115
Lever 14, 41
List display 142, 148
List display area 53, 55
Local maximum position 156
Local minimum position 156
Logger Utility 16, 28
Logic 55, 75, 95
Logic signal 32, 38
Lower limit value 116

M

MAC address 14, 70, 205
Main screen 53
Maximum times for recording A7
Maximum value 151, 152
Measurable range 222, 224
Measurement accuracy 222, 224
Measurement condition 53, 89, 160
Measurement range 222
Measurment range 224
Memory capacity 215
Memory usage status 160
Menu bar 53, 54
Minimum value 151, 152
Model 69
Model 8948 Voltage/Temp Unit 3, 32, 90, 221
Model 8949 Universal Unit 3, 32, 223
Model 8996 Digital Pulse Unit 3, 32
Model 8997 Alarm Unit 3, 32, 227
Model 9642 LAN Cable 43, 71
Model 9683 Connection Cable 3, 48, 74
Monitor display 161
Mouse operation 17

N

Narrowing down of display channels 129
Noise 75
Normal recording 85

Normal sampling	77
Number of measurement data	160
Number of units	215
Numerical display	149

O

Off count	151
Off time	151
On count	151
On time	151
One PC and one instrument	71
One-to-one	43, 73
Operating environment	216
Operating temperature and humidity	216
OR	112
Output data to Excel	167

P

Peak-to-peak value	152
Point	149
Port	193
Port number	65, 69
Power outage	126
Power supply	215
Power switch	12, 52
P-P	151, 152
Pre-trigger	109
Print	176
Print Format	176
Print Interval	176
Process all	128
production No	70
Production No.	66
Pulse	38, 93, 94
Pulse/rotation rate	93

R

RAM check	198
Range	89
Rated voltage	132
Reading	163, 169
Real-time save	123
Recording interval	77, 215
Recording settings	85
Reference junction compensation format	91
Registering manually	68
Relative time	149
Repeat recording	87
Resistance temperature detector	38, 92
Resolution	222, 224
ROM check	197
ROM version	203
Rotation rate	38, 94

S

Sampling speed	77
Save	123, 163
Save directory	163
Scaling	98
Scaling examples	102
Scan timing	A1
Screen	53
Scrollbar	146
Searching	64, 155
Seconds	149
Self check	197
Serial No.	14, 66, 70, 206
Set the time	67, 189
Setting by 2 points	98
Setting by ratio	98
Setting data	170
Setting file	207
Setting method	186
Setting mode	186
Settings screen	53, 56
SI unit	149
Slope	93
SMPL/TRIG	50, 122
SMPL/TRIG terminal	105, 122
Specifications	215
Specify by time	156
Split screen	143
Standalone measurement	11, 16, 137
Standard deviation	151, 152
START	50, 122
Start backup	126
Start measurement	135
Start time	160
START/MARK key	13
Status bar	53
STOP	50, 122
STOP key	13
Storage RAM	198
Storage temperature and humidity	216
Subnet mask	69, 192
Synchronization cable	48
Synchronization cable connectors	12
Synchronized measurement	11, 74, 187
System reset	233

T

Temperature measurement	91, 92
Terminal block	35
Text format	164
Thermocouple	38, 91
Threshold	93
Time to maximum	151, 152

Index 4

Index

Time to minimum	151, 152
Timeout	70
Timer measurement	88
Tool button	53, 54
Totalization value	152
Totalized pulse measurement	93
Trigger	105
Trigger condition	114
Trigger resolution	115
Trigger source	112
Trigger timing	111

U

Uninstall	30
Unit	101
Unit configuration	76
Upper limit value	116
USB cable	43
USB connector	12
USB driver	17

V

Variation	158
Version update	A2
View menu	54
Voltage	90
Voltage measurement	38

W

Warning message	13, A3
Waveform background color	145
Waveform calculation	96
Waveform display	142, 143
Waveform display area	53, 55
Waveform display range	140
Waveform file	163
Window	157
Window trigger	116
Work RAM	198

Z

Zero-position	234
Zero-position adjustment	221, 223, 234

HIOKI

<http://www.hioki.com>



**Our regional
contact
information**

HEADQUARTERS

81 Koizumi
Ueda, Nagano 386-1192 Japan

HIOKI EUROPE GmbH

Rudolf-Diesel-Strasse 5
65760 Eschborn, Germany
hioki@hioki.eu

1808EN

Edited and published by HIOKI E.E. CORPORATION

Printed in Japan

- CE declarations of conformity can be downloaded from our website.
- Contents subject to change without notice.
- This document contains copyrighted content.
- It is prohibited to copy, reproduce, or modify the content of this document without permission.
- Company names, product names, etc. mentioned in this document are trademarks or registered trademarks of their respective companies.