



**Agilent U1251A and
U1252A
Handheld Digital
Multimeter**

User's and Service Guide



Agilent Technologies

Notices

© Agilent Technologies, Inc. 2006, 2007

No part of this manual may be reproduced in any form or by any means (including electronic storage and retrieval or translation into a foreign language) without prior agreement and written consent from Agilent Technologies, Inc. as governed by United States and international copyright laws.

Manual Part Number

U1251-90003

Edition

Fourth Edition, May 27, 2007

Printed in Malaysia

Agilent Technologies, Inc.
3501 Stevens Creek Blvd.
Santa Clara, CA 95052 USA

Technology Licenses

The hardware and/or software described in this document are furnished under a license and may be used or copied only in accordance with the terms of such license.

Restricted Rights Legend

U.S. Government Restricted Rights. Software and technical data rights granted to the federal government include only those rights customarily provided to end user customers. Agilent provides this customary commercial license in Software and technical data pursuant to FAR 12.211 (Technical Data) and 12.212 (Computer Software) and, for the Department of Defense, DFARS 252.227-7015 (Technical Data - Commercial Items) and DFARS 227.7202-3 (Rights in Commercial Computer Software or Computer Software Documentation).

Warranty

The material contained in this document is provided “as is,” and is subject to being changed, without notice, in future editions. Further, to the maximum extent permitted by applicable law, Agilent disclaims all warranties, either express or implied, with regard to this manual and any information contained herein, including but not limited to the implied warranties of merchantability and fitness for a particular purpose. Agilent shall not be liable for errors or for incidental or consequential damages in connection with the furnishing, use, or performance of this document or of any information contained herein. Should Agilent and the user have a separate written agreement with warranty terms covering the material in this document that conflict with these terms, the warranty terms in the separate agreement shall control.

Accessories Warranty

Agilent offers warranty for product’s accessories for up to 3 months from the end-user acceptance date.

Standard Calibration Service (optional)

Agilent offers an optional calibration service contract for a period of 3 years from end-user acceptance date.

Safety Notices

CAUTION

A **CAUTION** notice denotes a hazard. It calls attention to an operating procedure, practice, or the like that, if not correctly performed or adhered to, could result in damage to the product or loss of important data. Do not proceed beyond a **CAUTION** notice until the indicated conditions are fully understood and met.

WARNING

A **WARNING** notice denotes a hazard. It calls attention to an operating procedure, practice, or the like that, if not correctly performed or adhered to, could result in personal injury or death. Do not proceed beyond a **WARNING** notice until the indicated conditions are fully understood and met.

Safety Information

This meter is safety-certified in compliance with EN/IEC 61010-1:2001, UL 61010-1 Second Edition and CAN/CSA 22.2 61010-1 Second Edition, Category III 1000 V Overvoltage Protection, Pollution Degree II. Use with standard or compatible test probes.

WARNING

A **WARNING** notice denotes a hazard. It calls attention to an operating procedure, practice, or the like that, if not correctly performed or adhered to, could result in personal injury or death. Do not proceed beyond a **WARNING** notice until the indicated conditions are fully understood and met.

A **CAUTION** notice denotes a hazard. It calls attention to an operating procedure, practice, or the like that, if not correctly performed or adhered to, could result in damage to the product or loss of important data. Do not proceed beyond a **CAUTION** notice until the indicated conditions are fully understood and met.

Use the meter only as specified in this guide. Otherwise, the protection provided by the meter may be impaired.

Refer to the safety information below:

WARNING





- When working above 70V DC, 33 V AC RMS or 46.7 V peak, exercise caution – such range pose a shock hazard.
- Do not measure more than the rated voltage (as marked on the meter) between terminals, or between terminal and earth ground.
- Double-check the meter's operation by measuring a known voltage.
- For current measurement, turn off circuit power before connecting the meter to the circuit. Always place the meter in series with the circuit.
- When connecting probes, always connect the common test probe first. When disconnecting probes, always disconnect the live test probe first.
- Detach test probes from the meter before you open the battery cover.
- Do not use the meter with the battery cover or part of the cover removed or loose.
- Replace the battery as soon as the low battery indicator  flashes on screen. This is to avoid false readings, which may lead to possible electric shock or personal injury.
- Do not operate the product in an explosive atmosphere or in the presence of flammable gases or fumes.

- Inspect the case for cracks or missing plastic. Pay extra attention to the insulation surrounding the connectors. Do not use the meter if it is damaged.
- Inspect the test probes for damaged insulation or exposed metal, and check for continuity. Do not use the test probe if it is damaged.
- Do not use any other AC charger adaptor apart from the one certified by Agilent with this product.
- Do not use repaired fuses or short-circuited fuse-holders. For continued protection against fire, replace the line fuses only with fuses of the same voltage and current rating and recommended type.
- Do not service or perform adjustments alone. Under certain condition, hazardous voltages may exist, even with the equipment switched off. To avoid dangerous electric shock, service personnel must not attempt internal service or adjustment unless another person, capable of rendering resuscitation or first aid, is present.
- Do not substitute parts or modify equipment to avoid the danger of introducing additional hazards. Return the product to Agilent Technologies Sales and Service Office for service and repair to ensure the safety features are maintained
- Do not operate damaged equipment as the safety protection features built into this product may have been impaired, either through physical damage, excessive moisture, or any other reason. Remove power and do not use the product until safe operation can be verified by service-trained personnel. If necessary, return the product to Agilent Technologies Sales and Service Office for service and repair to ensure the safety features are maintained.







CAUTION

- Turn off circuit power and discharge all high-voltage capacitors in the circuit before you perform resistance, continuity, diodes, or capacitance tests.
- Use the correct terminals, function, and range for your measurements.
- Never measure voltage when current measurement is selected.
- Use only recommended rechargeable battery. Ensure proper insertion of battery in the meter, and follow the correct polarity.
- Disconnect test leads from all the terminals during battery charging.

Safety Symbols

CAT III 1000 V	Category III 1000 V Overvoltage Protection
	Double insulation
	Earth ground
	Caution, risk of danger (Refer to the User's and Service Guide for details)
	Caution, risk of electric shock

Regulatory Markings

 ICES/NMB-001 ISM 1-A	The CE mark is a registered trademark of the European Community. This CE mark shows that the product complies with all the relevant European Legal Directives. If it was accompanied by a year, it indicates the year the design was approved. This ISM device complies with Canadian ICES-001.
 C US	The CSA mark is a registered trademark of the Canadian Standards Association.
 c us LISTED MEASURING EQUIPMENT 90AJ	The UL mark is a registered trademark of Underwriters Laboratories Inc.
 N10149	The C-tick mark is a registered trademark of the Spectrum Management Agency of Australia. This signifies compliance with the Australia EMC Framework regulations under the terms of the Radio Communication Act of 1992.
 	This instrument complies with the WEEE Directive (2002/96/EC) marking requirement. This affixed product label indicates that you must not discard this electrical/electronic product in domestic household waste.



Agilent Technologies

DECLARATION OF CONFORMITY
According to ISO/IEC Guide 22 and CEN/CENELEC EN 45014



Manufacturer's Name: Agilent Technologies Microwave Products (M) Sdn. Bhd
Manufacturer's Address: Bayan Lepas Free Industrial Zone,
11900, Bayan Lepas, Penang, Malaysia

Declares under sole responsibility that the product as originally delivered

Product Name: Handheld Digital Multimeter
Model Number: U1251A, U1252A
Product Options: This declaration covers all options of the above product(s)

complies with the essential requirements of the following applicable European Directives, and carries the CE marking accordingly:

Low Voltage Directive (73/23/EEC, amended by 93/68/EEC)
EMC Directive (89/336/EEC, amended by 93/68/EEC)

and conforms with the following product standards:

EMC	Standard	Limit
	IEC 61326-1:1997+A1:1998 / EN 61326-1:1997+A1:1998	
	CISPR 11:1990 / EN55011:1991	Class A Group 1
	IEC 61000-4-2:1995+A1:1998 / EN 61000-4-2:1995	4 kV CD, 8 kV AD
	IEC 61000-4-3:1995 / EN 61000-4-3:1995	3 V/m, 80-1000 MHz
	IEC 61000-4-4:1995 / EN 61000-4-4:1995	0.5 kV signal lines, 1 kV power lines
	IEC 61000-4-5:1995 / EN 61000-4-5:1995	0.5 kV line-line, 1 kV line-ground
	IEC 61000-4-6:1996 / EN 61000-4-6:1996	3 V, 0.15-80 MHz
	IEC 61000-4-11:1994 / EN 61000-4-11:1994	1 cycle / 100%

Canada: ICES-001:1998
Australia/New Zealand: AS/NZS 2064.1

The product was tested in a typical configuration with Agilent Technologies test systems.

Safety IEC 61010-1:2001 / EN 61010-1:2001
Canada: CSA C22.2 No. 61010-1:2004
USA: UL 61010-1:2004

Supplementary Information:

U1251A is provided with 9Vdc non-rechargeable battery, without AC power adaptor.
U1252A is provided with 9Vdc rechargeable battery, with AC power adaptor (U1170A).
IEC/EN61000-4-4, -4-5, -4-6, -4-11 are applicable for the AC power adaptor configuration for model U1252A.

This DoC applies to above-listed products placed on the EU market after:

22-August-2006

Date

Mack Soh

Quality Manager

For further information, please contact your local Agilent Technologies sales office, agent or distributor,
or Agilent Technologies Deutschland GmbH, Herrenberger Straße 130, D 71034 Böblingen, Germany.

Template: A5971-5302-2, Rev. B.01

U1251A

Rev 1.0

Product Regulations

EMC		Performance Criteria ¹	
		U1251A	U1252A
	IEC 61326-1:1997+A1:1998 / EN 61326-1:1997+A1:1998		
	CISPR 11:1990 / EN 55011:1991 – Group 1 Class A		
	IEC 61000-4-2:1995+A1:1998 / EN 61000-4-2:1995 (ESD 4kV CD, 8kV AD)	B	B
	IEC 61000-4-3:1995 / EN 61000-4-3:1995 (3V/m, 80% AM)	A	A
	IEC 61000-4-4:1995 / EN 61000-4-4:1995 (EFT 0.5kV line-line, 1kV line-earth)	N/A	A
	IEC 61000-4-5:1995 / EN 61000-4-5:1995 (Surge 0.5kV line-line, 1kV line-earth)	N/A	A
	IEC 61000-4-6:1996 / EN 61000-4-6:1996 (3V, 0.15~80 MHz, 80% AM, power line)	N/A	A
	IEC 61000-4-11:1994 / EN 61000-4-11:1994 (Dips 1 cycle, 100%)	N/A	A
	Canada: ICES-001:1998		
	Australia/New Zealand: AS/NZS 2064.1		
Safety	IEC 61010-1:2001 / EN 61010-1:2001		
	Canada: CSA C22.2 No. 61010-1:2004		
	USA: UL 61010-1: 2004		

Additional Information:

The product herewith complies with the essential requirements of the Low Voltage Directive 73/23/EEC and the EMC Directive 89/336/EEC (including 93/68/EEC) and carries the CE Marking accordingly (European Union).

¹Performance Criteria:

- A Pass - Normal operation, no effect.
- B Pass - Temporary degradation, self recoverable.
- C Pass - Temporary degradation, operator intervention required.
- D Fail - Not recoverable, component damage.
- N/A – Not applicable

Notes:

Regulatory Information for Canada

ICES/NMB-001:1998
This ISM device complies with Canadian ICES-001.
Cet appareil ISM est conforme à la norme NMB-001 du Canada.

Regulatory Information for Australia/New Zealand

This ISM device complies with Australian/New Zealand AS/NZS 2064.1



Contents

1	Getting Started Tutorial	13
	Introducing the Agilent U1251A and U1252A Handheld Digital Multimeter	14
	Adjusting the Tilt-Stand	15
	The Front Panel at a Glance	17
	The Rotary Switch at a Glance	18
	The Keypad at a Glance	19
	The Display at a Glance	21
	Selection of Display by Hz Button	25
	Selection of Display by Dual Button	27
	Selection of Display by SHIFT Button	30
	The Terminals at a Glance	32
	The Rear Panel at a Glance	33
2	Making Measurements	35
	Measuring Voltage	36
	Measuring Current	39
	Measuring DC voltage	38
	Measuring Current	39
	μ A & mA Measurement	39
	% Scale of 4–20 mA	40
	A measurement	41
	Frequency Counter	42
	Measuring Resistance, Conductance and Testing Continuity	44
	Testing Diodes	48
	Measuring Capacitance	51
	Measuring Temperature	52
	Alerts and Warning During Measurement	55
	Overload Alert	55
	Input Warning	55
	Charge Terminal Alert	56

3	Features and Functions	57
	Dynamic Recording	58
	Data Hold (Trigger Hold)	60
	Refresh Hold	61
	NULL (Relative)	63
	Decibel Display	65
	1 ms Peak Hold	67
	Data Logging	69
	Manual Logging	69
	Interval Logging	71
	Reviewing Logged Data	73
	Square Wave Output (for U1252A)	75
	Remote Communication	80
4	Changing The Default Setting	81
	Selecting Setup Mode	82
	Setting Data Logging Mode	86
	Setting Thermocouple Types (for U1252A)	87
	Setting Reference Impedance for dBm Measurement	88
	Setting Minimum Frequency Measurement	89
	Setting Temperature Unit	90
	Setting Auto Power Saving Mode	92
	Setting % Scale Readout	94
	Setting Beep Frequency	95
	Setting Backlit Timer	96
	Setting Baud Rate	97
	Setting Parity Check	98
	Setting Data Bit	99
	Setting Echo Mode	100
	Setting Print Mode	101
	Returning to Default Factory Settings	102
5	Maintenance	103
	Introduction	104
	General Maintenance	104
	Battery Replacement	105
	Charging Battery	106
	Fuse Replacement	113

	Troubleshooting	115
6	Accessories	117
	Checking the Shipping Contents	118
	List of Accessories	119
7	Performance Tests and Calibration	121
	Calibration Overview	122
	Closed - case Electronic Calibration	122
	Agilent Technologies Calibration Services	122
	Calibration Interval	122
	Adjustment is Recommended	123
	Recommended Test Equipment	124
	Basic Operating Test	125
	Backlit Test	125
	Testing the Display	125
	Current Terminal Test	126
	Charge Terminal Alert Test	127
	Test Considerations	128
	Input Connections	129
	Performance Verification Tests	130
	Calibration Security	138
	Unsecuring the Instrument for Calibration	139
	Calibration Process	142
	Using the Front Panel for Adjustments	143
	Adjustments Consideration	144
	Valid Adjustment Input Values	145
	Adjustment Procedure	146
	Finishing the Adjustment	153
	To Read the Calibration Count	153
	Calibration Errors	154
8	Specifications	155
	DC Specifications	158
	U1251A AC Specifications	160
	U1252A AC Specifications	161

Contents

U1252A AC+DC Specifications	162
Temperature and Capacitance Specifications	163
U1251A & U1252A Frequency Specifications(1)	164
Operating Specifications	167
General Specifications	168



1 Getting Started Tutorial

Introducing the Agilent U1251A and U1252A Handheld Digital Multimeter	14
Adjusting the Tilt-Stand	15
The Front Panel at a Glance	17
The Rotary Switch at a Glance	18
The Keypad at a Glance	19
The Display at a Glance	21
Selection of Display by Hz Button	25
Selection of Display by Dual Button	27
Selection of Display by SHIFT Button	30
The Terminals at a Glance	32
The Rear Panel at a Glance	33

This chapter contains a brief description on the front panel of the Agilent U1251A and U1252A Handheld Digital Multimeter.



Introducing the Agilent U1251A and U1252A Handheld Digital Multimeter

The handheld digital multimeters' key features are:

- DC, AC and AC + DC (only U1252A) voltage and current measurements.
- True-RMS measurement for both AC voltage and current
- Rechargeable Ni-MH battery with built-in charging capability (only U1252A)
- Ambient temperature on second display
- Battery capacity indicator
- Blue LED backlight
- Resistance measurement up to $50\text{M}\Omega$ (for U1251A) and $500\text{M}\Omega$ (for U1252A)
- Conductance measurement from 0.01nS ($100\text{G}\Omega$) ~ 50nS
- Capacitance measurement up to 100mF
- Frequency counter up to 20MHz (only U1252A)
- The % scale readout for 4-20mA or 0-20mA measurement
- dBm with selectable reference impedance
- 1ms Peak Hold to catch inrush voltage and current easily
- Temperature test with selectable $0\text{ }^{\circ}\text{C}$ compensation (without ambient temperature compensation).
- K-type (for U1251A) and J/K-types temperature measurement (for U1252A)
- Frequency, duty cycle and pulse width measurements
- Dynamic Recording for min, max and average readings
- Data Hold with manual or auto trigger and Null mode
- Diode and audible continuity tests
- Square wave generator with selectable frequency, pulse width and duty cycle (only U1252A)
- Agilent GUI Application Software (IR-USB cable sold separately)
- Closed case calibration

- 50,000 count precision true RMS digital multimeter, designed to meet EN/IEC 61010-1:2001 Category III 1000 V Overvoltage Protection, Pollution Degree II standards

Adjusting the Tilt-Stand

To adjust the meter to a 60° standing position, pull the tilt-stand outwards to its maximum reach.

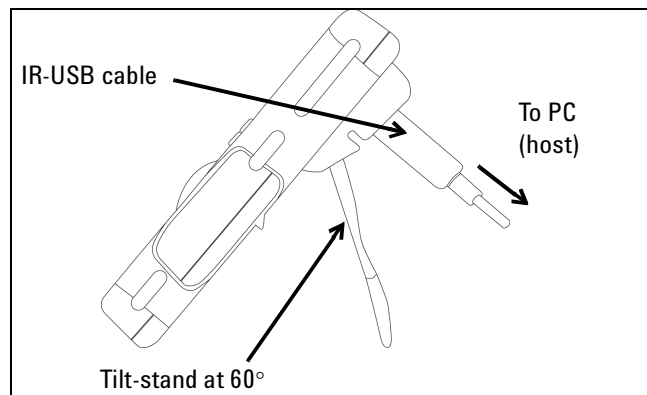

To adjust the meter to a 30° standing position, bend the tip of the stand so that it is parallel to ground before pulling the stand outwards to its maximum reach.

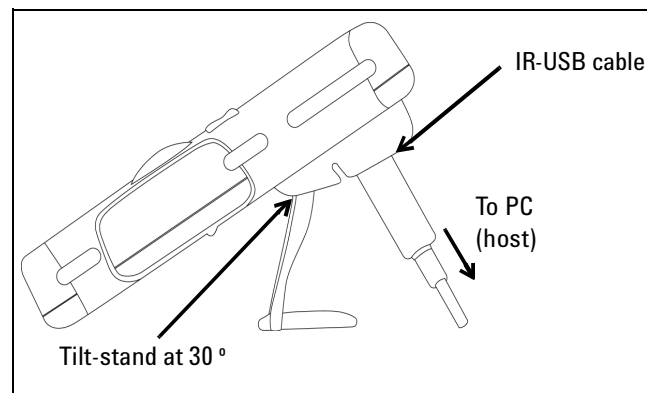

To adjust the meter to a hanging position, flip the stand upwards and over its maximum reach until it is detached from its hinge. Then flip the stand over so that the stand's inner surface is facing the meter's rear. Now, press the stand down into its hinge. Follow the step by step pictorial instructions below.



The Front Panel at a Glance

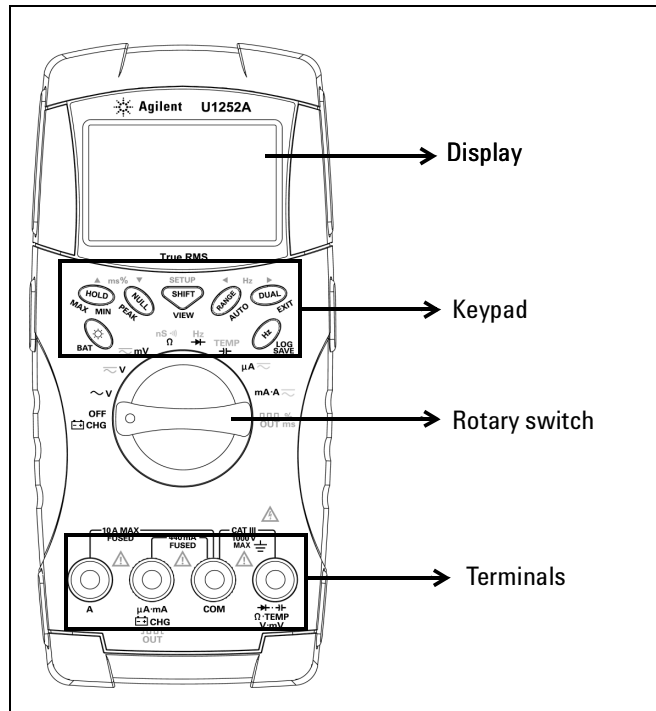

The Rotary Switch at a Glance

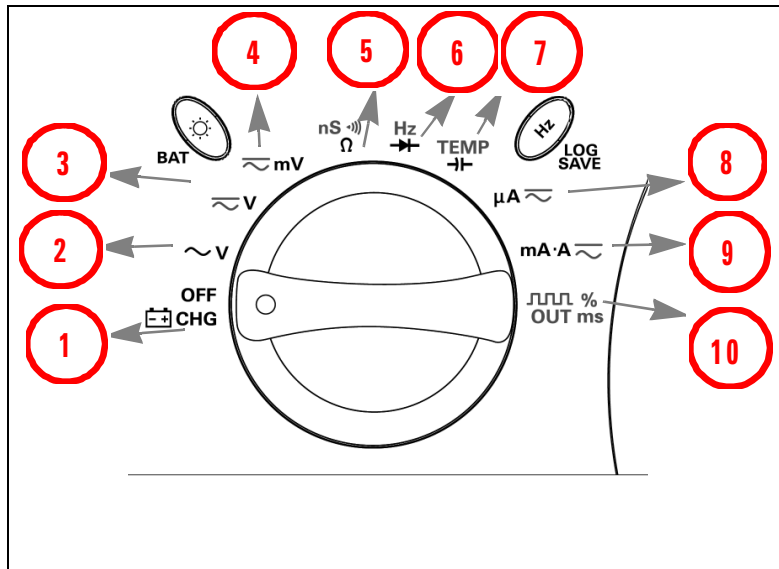

Legend:

No.	Description / Function
1	Charge mode [U1252A only] or OFF
2	AC V
3	DC voltage or DC+AC voltage [U1252A only]
4	DC mV, AC mV, AC+DC mV [U1252A only]
5	Resistance (Ω), Continuity, and Conductance (nS)
6	Frequency counter [U1252A only] or Diode
7	Capacitance or Temperature
8	DC μ A and AC μ A
9	DC mA, DC current, AC mA or AC current
10	Square-wave output, Duty cycle or Pulse width output [for U1252A] and OFF [for U1251A]

The Keypad at a Glance

The operation of each key is shown below. Pressing a key illuminates a related symbol on the display and sounds the beeper. Turning the rotary switch to another position resets the current operation of the key.

Figure 1 shows the keypad of the U1252A. The **ms%** (Pulse width/Duty cycle), **◀ Hz ▶**, and frequency counter functions are only available on the U1252A.

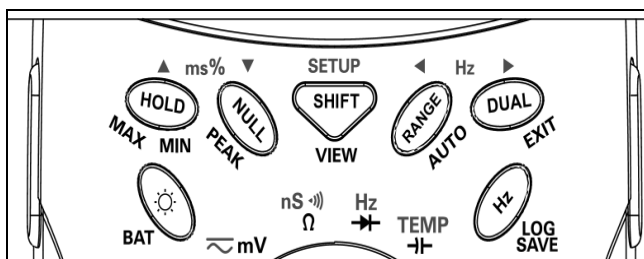

































Figure 1 U1252A Keypad

Table 1 Keypad Description/Functions

	Function when pushed for less than 1 second	Function when pushed for more than 1 second
1	 acts as a toggle switch to turn backlit ON/OFF. Backlit automatically turns off after 30s (default) ⁽¹⁾ .	 displays battery capacity for 3 seconds
2	 measured value. In Data Hold mode, push again to trigger hold of the next measured value. In Refresh Hold mode, reading updates automatically once reading is stable and count setting is exceeded ⁽¹⁾ .	 enters Dynamic Recording mode. Push  again to scroll through Max, Min, Avg and present (indicated by MAXMINAVG on display) readings.
3	 saves displayed value as a reference to be subtracted from subsequent measurements. Push again to see the relative value that has been saved.	 enters 1 ms Peak Hold mode. Push  to scroll through Max and Min peak readings.

	Function when pushed for less than 1 second	Function when pushed for more than 1 second
4	 scrolls through measuring function(s) at a particular rotary switch position.	 enters Log Review mode. Push  to switch to manual or interval logging data. Push  or  to view first or last logged data respectively. Push  or  to scroll up or down logged data. Push  for more than 1 second to exit mode.
5	 scrolls through available measuring ranges (except when rotary switch is at TEMP or Hz [for U1252A] position) ⁽²⁾ .	 sets to Auto Range mode.
6	 scrolls through available dual-combination displays (except when rotary switch is at TEMP or $\frac{\mu\text{V}}{\text{OUT}} \frac{\%}{\text{ms}}$ [for U1252A] position, or when meter is in 1 ms peak hold or dynamic recording mode) ⁽³⁾ .	 exits Hold, Null, Dynamic Recording, 1 ms Peak Hold and dual display modes.
7	 enters Frequency Test mode for current or voltage measurements. Push  to scroll through frequency (Hz), duty cycle (%) and pulse width (ms) functions. In duty cycle (%) and pulse width (ms) tests, push  to switch to positive or negative pulse.	 enters logging mode. In manual data logging, push  to log data manually into memory. In automatic data logging, data logs automatically ⁽¹⁾ . Push  for more than 1 second to exit auto data logging mode.

NOTE

1. See **Table 3**, "Available setting options in Setup mode," for details of available options.
2. When rotary switch is at TEMP, push  to switch to °C or °F display. When rotary switch is at Hz, push  to switch to division of signal frequency by 1 or 100.
3. When rotary switch is at TEMP, ETC is ON by default. You may push  to disable ETC (Environment Temperature Compensation), **0°C** will appear on display. For pulse and duty cycle measurement, push  to switch trigger slope to positive or negative. When meter is in peak or dynamic-recording mode, push  to restart 1 ms peak hold or dynamic recording mode.

The Display at a Glance

To view the full display (with all segments illuminated), push









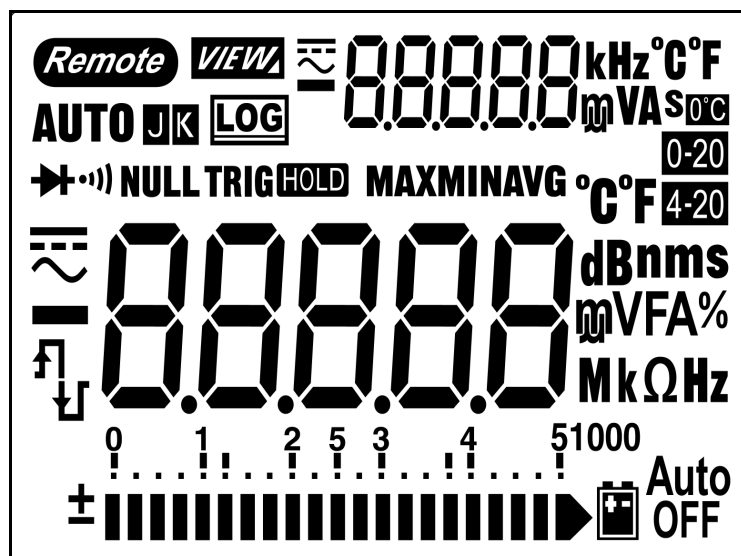









button and hold while turning the rotary switch from OFF to any non- OFF position. After you are done viewing the full display, push any button to resume normal functionality based on the rotary switch position. This is followed by a wake-up feature.

The meter will then enter power save mode once auto power off (APF) is enable. To wake the meter up:





- 1 Turn the rotary switch (knob) to OFF position, and then turn it back on again.
- 2 Press any button for rotary switch position that is not at square wave output position. This only available for U1252A.
- 3 For U1252A only, rotary switch at square wave out position, press only DUAL, RANGE and HOLD buttons or turn the rotary switch to other position.





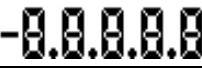

The LCD signs are described on page 22, 23 and 24.

LCD Sign	Description
	Remote control
	Thermocouple types:  (K-type)  (J-type)
NULL	Null math function
	Diode / Audible continuity
	Audible continuity for resistance
	View mode for checking logged data
	Data logging indication
	Square wave output (only U1252A)
	<ul style="list-style-type: none"> • Positive slope for pulse width (ms) and duty cycle (%) measurement • Charging capacitor as capacitance measurement
	<ul style="list-style-type: none"> • Negative slope for pulse width (ms) and duty cycle (%) measurement • Discharging capacitor as capacitance measurement
	Low battery indication
Auto OFF	Auto power off enable
	Refresh (auto) Hold
TRIG 	Trigger (manual) Hold
MAXMINAVG	Dynamic Recording mode: Present value on primary display
MAX	Dynamic Recording mode: Maximum value on primary display
MIN	Dynamic Recording mode: Minimum value on primary display
AVG	Dynamic Recording mode: Average value on primary display
 MAX	1ms Peak Hold mode: Positive peak value on primary display
 MIN	1ms Peak Hold mode: Negative peak value on primary display

The primary display signs are described below.

LCD Sign	Description
Auto	Auto range
	AC + DC
	DC
	AC
	Polarity, digits and decimal points for primary display
dBm	Decibel unit relative to 1 mW
dBV	Decibel unit relative to 1 V
MkHz	Frequency units: Hz, kHz, MHz
MkΩ	Resistance units: Ω, kΩ, MΩ
nS	Conductance unit
mV	Voltage units: mV, V
μmA	Current units: μA, mA, A
%	Duty cycle measurement
ms	Pulse width unit
μmF	Capacitance units: nF, μF, mF
°C	Celsius temperature unit
°F	Fahrenheit temperature unit
	Percentage scale readout proportional to DC 0–20 mA
	Percentage scale readout proportional to DC 4–20 mA









The secondary display signs are described below.

LCD Sign	Description
	AC + DC
	DC
	AC
	Polarity, digits and decimal points for secondary display
kHz	Frequency units: Hz, kHz
	No ambient temperature compensation, just thermocouple measurement
°C	Celsius ambient temperature unit
°F	Fahrenheit ambient temperature unit
mV	Voltage units: mV, V
µA	Current units: µA, mA, A
s	Elapsed time unit: s (second) for Dynamic Recording and 1 ms Peak Hold modes

The analog bar graph likens the needle on an analog meter, except without the overshoot being displayed. When measuring peak on null adjustments and viewing fast-changing inputs, the bar graph provides useful indication because it has faster update rates for fast response application.



The bar graph is not used for square wave output, frequency, duty cycle, pulse width, 4–20 mA% scale, 0–20 mA% scale and temperature measurements. When frequency, duty cycle and pulse width are indicated on the primary display during voltage or current measurement, the bar graph represents the voltage or current value. When 4–20 mA% scale or 0–20 mA% scale is indicated on the primary display, the bar graph represents the current value.











The “+” or “-” sign is indicated when the positive or negative value has been measured or calculated. Each segment represents 25000 or 500 counts depending on the range indicated on the peak bar graph. See the table below.







Range	Counts / Segment	Used for the Function
	25000	V, A, Ω , Diode
	25000	V, A, Ω
	25000	V, A, Ω , nS
	500	V, A, 
	500	
	500	

Selection of Display by Hz Button

The frequency measuring helps to detect the presence of harmonic currents in neutral conductors and determines whether these neutral currents are the result of unbalanced phases or non-linear loads. Pushing  enters Frequency

measurement mode for current or voltage measurements – voltage or current on secondary display and frequency on primary display. Alternatively, pulse width (ms) or duty cycle (%) can appear on the primary display by pushing  again. This allows simultaneous monitoring of real-time voltage or current with frequency, duty cycle or pulse width. Voltage or current resumes on primary display after you push and hold  for more than 1 second.









Rotary switch position (Function)	Primary display	Secondary display
 V  V for U1252A (AC voltage)	Frequency (Hz)	AC V
	Pulse width (ms)	
	Duty cycle (%)	
 V for U1251A  V for U1252A (DC voltage)	Frequency (Hz)	DC V
	Pulse width (ms)	
	Duty cycle (%)	
 V for U1252A (AC + DC voltage)	Frequency (Hz)	AC + DC V
	Pulse width (ms)	
	Duty cycle (%)	
 mV (AC voltage)	Frequency (Hz)	AC mV
	Pulse width (ms)	
	Duty cycle (%)	
 mV (DC voltage)	Frequency (Hz)	DC mV
	Pulse width (ms)	
	Duty cycle (%)	
 mV (AC + DC voltage) [for U1252A]	Frequency (Hz)	AC + DC mV
	Pulse width (ms)	
	Duty cycle (%)	
 A  (AC Current)	Frequency (Hz)	AC μ A
	Pulse width (ms)	
	Duty cycle (%)	

μA  (DC current)	Frequency (Hz)	DC μA
	Pulse width (ms)	
	Duty cycle (%)	
μA  (AC + DC current) [for U1252A]	Frequency (Hz)	AC + DC μA
	Pulse width (ms)	
	Duty cycle (%)	
$\text{mA}\cdot\text{A}$  (AC current)	Frequency (Hz)	AC mA or A
	Pulse width (ms)	
	Duty cycle (%)	
$\text{mA}\cdot\text{A}$  (DC current)	Frequency (Hz)	DC mA or A
	Pulse width (ms)	
	Duty cycle (%)	
$\text{mA}\cdot\text{A}$  (AC + DC current) [for U1252A]	Frequency (Hz)	AC + DC mA
	Pulse width (ms)	
	Duty cycle (%)	
Hz (Frequency counter) - push  to select frequency division by 1 [for U1252A]	Frequency (Hz)	- 1 -
	Pulse width (ms)	
	Duty cycle (%)	
Hz (Frequency counter) - push  to select frequency division by 100 [for U1252A]	Frequency (Hz)	- 100 -

Selection of Display by Dual Button

Push  to select different combinations of dual display.





Normal single display resumes after you push and hold  for more than 1 second. See table below.

Rotary switch position (Function)	Primary display	Secondary display
 (AC voltage)	AC V	Hz (AC coupling)
	dBm or dBV (select by pushing )	AC V
	AC V	Ambient temperature °C or °F
 (AC voltage)	AC V	Hz (AC coupling)
	dBm or dBV ⁽¹⁾	AC V
	AC V	DC V
	AC V	Ambient temperature °C or °F
 for U1251A/  for U1252A (DC voltage)	DC V	Hz (DC coupling)
	dBm or dBV ⁽¹⁾	DC V
	DC V	AC V [for U1252A]
	DC V	Ambient temperature °C or °F
 (AC + DC voltage)	AC + DC V	Hz (AC coupling)
	dBm or dBV ⁽¹⁾	AC + DC V
	AC + DC V	AC V
	AC + DC V	DC V
	AC + DC V	Ambient temperature °C or °F
 (AC voltage)	AC mV	Hz (AC coupling)
	dBm or dBV ⁽¹⁾	AC mV
	AC mV	DC mV
	AC mV	Ambient temperature °C or °F
 (DC voltage)	DC mV	Hz (DC coupling)
	dBm or dBV ⁽¹⁾	DC mV
	DC mV	AC mV
	DC mV	Ambient temperature °C or °F

NOTE





[1] Reading of dBm or dBV depends on the last review on AC V. If the last review is dBV, the following display will also remain in dBV.







\tilde{mV} (AC + DC voltage) [for U1252A]	AC + DC mV	Hz (AC coupling)
	dBm or dBV	AC + DC mV
	AC + DC mV	AC mV
	AC + DC mV	DC mV
	AC + DC mV	Ambient temperature °C or °F
$\mu A \tilde{\quad}$ (DC current)	DC μA	Hz (DC coupling)
	DC μA	AC μA
	DC μA	Ambient temperature °C or °F
$\mu A \tilde{\quad}$ (AC current)	AC μA	Hz (AC coupling)
	AC μA	DC μA
	AC μA	Ambient temperature °C or °F
$\mu A \tilde{\quad}$ (AC + DC current) [for U1252A]	AC + DC μA	Hz (AC coupling)
	AC + DC μA	AC μA
	AC + DC μA	DC μA
	AC + DC μA	Ambient temperature °C or °F
$m A \cdot A \tilde{\quad}$ (DC current)	DC mA	Hz (DC coupling)
	DC mA	AC mA
	%(0–20 or 4–20)	DC mA
	DC mA	Ambient temperature °C or °F
$m A \cdot A \tilde{\quad}$ (AC current)	AC mA	Hz (AC coupling)
	AC mA	DC mA
	AC mA	Ambient temperature °C or °F
$m A \cdot A \tilde{\quad}$ (AC + DC current) [for U1252A]	AC + DC mA	Hz (AC coupling)
	AC + DC mA	AC mA
	AC + DC mA	DC mA
	AC + DC mA	Ambient temperature °C or °F
$m A \cdot A \tilde{\quad}$ (DC current)	DC A	Hz (DC coupling)
	DC A	AC A
	DC A	Ambient temperature °C or °F
$m A \cdot A \tilde{\quad}$ (AC current)	AC A	Hz (AC coupling)
	AC A	DC A

mA·A  (AC + DC current) [for U1252A]	AC A	Ambient temperature °C or °F
	AC + DC A	Hz (AC coupling)
	AC + DC A	AC A
	AC + DC A	DC A
	AC + DC A	Ambient temperature °C or °F
 (Capacitance)  (Diode)/ Ω (Resistance)/ nS (Conductance)	nF / V / Ω / nS	Ambient temperature °C or °F
TEMP (Temperature)	°C (°F)	Ambient temperature °C or °F
	°C (°F)	Ambient temperature °C or °F / 0°C compensation (select by pushing )

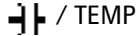

Selection of Display by SHIFT Button

Table below shows selection of primary display, with respect to measuring function (rotary switch position), using the SHIFT button.

Rotary switch position (Function)	Primary display
 (AC Voltage)	AC V
	dBm (in dual display mode) ⁽¹⁾
	dBV (in dual display mode) ⁽¹⁾
 V for U1251A	DC V
 V for U1252A (AC + DC Voltage)	DC V
	AC V
	AC + DC V
 mV for U1252A (AC + DC Voltage)	DC mV
	AC mV
	AC + DC mV

Ω	Ω
	 Ω
	nS
	Diode
	Hz
 / TEMP	Capacitance
	Temperature
μA 	DC μA
	AC μA
	AC + DC μA [for U1252A]
$\text{mA}\cdot\text{A}$ 	DC mA
	AC mA
	AC + DC mA
	%(0–20 or 4–20)
$\text{mA}\cdot\text{A}$ 	DC A
	AC A
	AC + DC A [for U1252A]
Square wave output for U1252A 	Duty cycle (%)
	Pulse width (ms)

NOTE

1. Push  to switch between dBm and dBV measurement.
Push  for more than 1 second to return to AC V measurement only.

The Terminals at a Glance

WARNING

To avoid damaging this device, do not exceed the input limit.

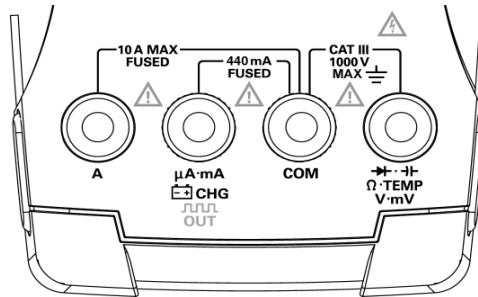

Figure 2 U1252A Connector terminals

Table 2 Terminal connections for different measuring functions

Rotary switch position	Input terminal		Overload protection
$\sim V$ $\sim V$ for U1252A $\equiv V$ for U1251A	$V \cdot mV \cdot \Omega$ $\rightarrow \cdot \rightarrow$ $\cdot TEMP$	COM	1000 V R.M.S., 1000 V R.M.S. for short circuit <0.3 A
$\sim mV$			
Ω			
$\rightarrow \cdot \rightarrow$			
$\rightarrow \cdot \rightarrow$			
$\mu A \sim$ $m A \cdot A \sim$	$\mu A \cdot mA$	COM	440 mA / 1000 V 30 kA fast-acting fuse
$m A \cdot A \sim$	A	COM	11 A / 1000 V 30 kA fast-acting fuse
$\rightarrow \cdot \rightarrow$ % OUT ms for U1252A	$\rightarrow \cdot \rightarrow$ % OUT ms	COM	
$\rightarrow \cdot \rightarrow$ CHG	$\rightarrow \cdot \rightarrow$ CHG	COM	440 mA / 1000 V fast-acting fuse

The Rear Panel at a Glance

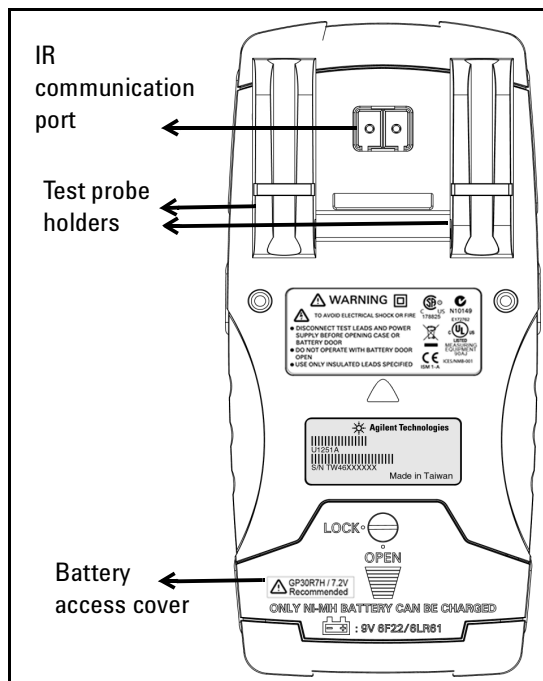
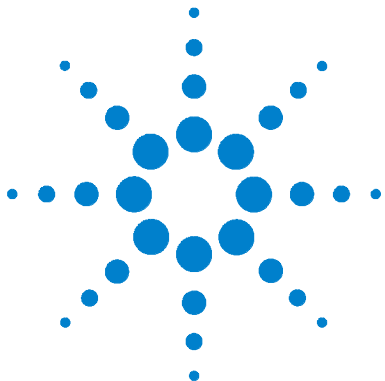

Figure 3 Rear panel of U1252A

1 Getting Started Tutorial



2 Making Measurements

Measuring Voltage	36
Measuring AC voltage	36
Measuring DC voltage	38
Measuring Current	39
μ A & mA Measurement	39
% Scale of 4–20 mA	40
A measurement	41
Frequency Counter	42
Measuring Resistance, Conductance and Testing Continuity	44
Testing Diodes	48
Measuring Temperature	52
Alerts and Warning During Measurement	55
Overload Alert	55
Input Warning	55
Charge Terminal Alert	56

This chapter contains the detail information on how measurements are taken using this handheld digital multimeter. It builds on information you learned in the Quick Start Guide.



Measuring Voltage

The meter offers true-RMS readings for AC measurements that are accurate for sine waves, square waves, triangle waves, staircase waves and other waveforms without any DC offset.

For AC with DC offset, use AC + DC measurement on $\sim V$ or $\sim mV$ rotary switch location. This applies only to U1252A.

WARNING

Ensure that terminal connections are correct for that particular measurement before any measurement. To avoid damaging the device, do not exceed the input limit.

Measuring AC voltage

- 1 Set the rotary switch to $\sim V$, $\sim V$ or $\sim mV$.
- 2 Connect the red and black test leads to input terminals **V.mV** and **COM** respectively.
- 3 Alternatively, push  to display frequency on secondary display.
- 4 Probe the test points and read the display.

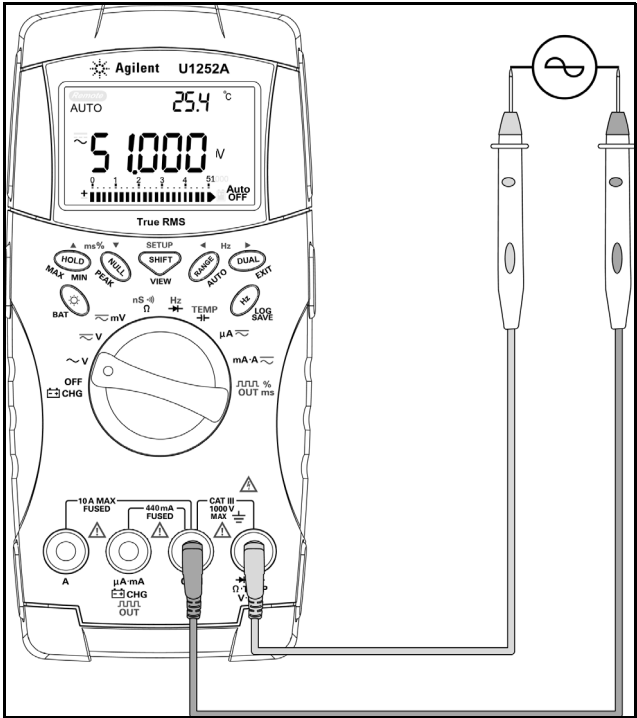

Figure 3 Measuring AC voltage

2 Making Measurements

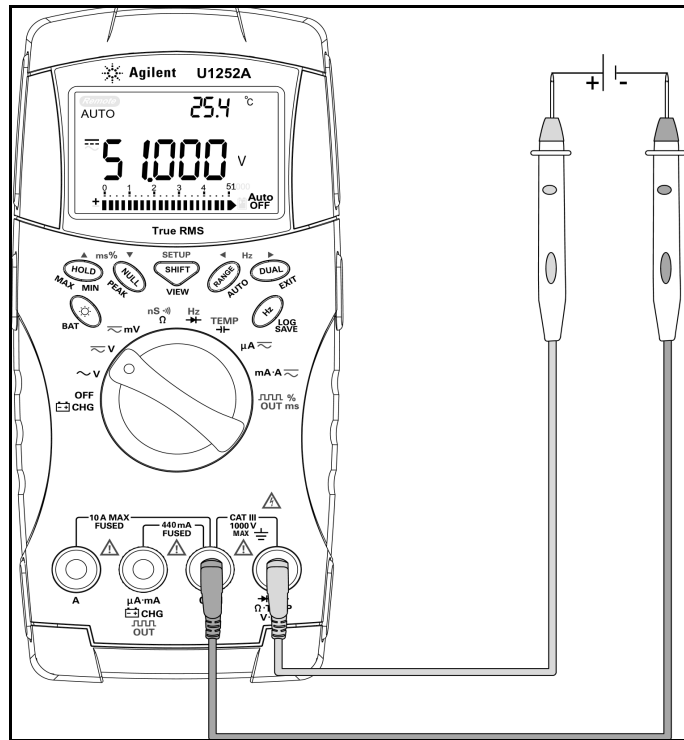

Figure 4 Measuring DC voltage

Measuring DC voltage

- 1 Set the rotary switch to $\overline{\sim}$ V and $\overline{\sim}$ mV .
- 2 Connect the red and black test leads to input terminals V.mV and COM respectively.
- 3 Probe the test points and read the display.

Measuring Current

μA & mA Measurement

- 1 Set the rotary switch to $\text{mA} \cdot \text{A} \sim$.
- 2 Connect the red and black test leads to input terminals $\mu\text{A} \cdot \text{mA}$ and **COM** respectively.
- 3 Probe the test points in series with the circuit, and read the display.

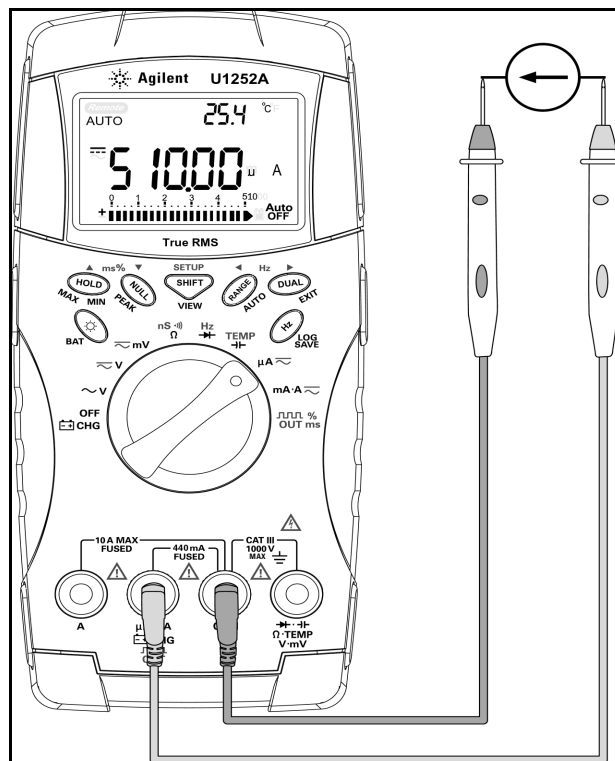

Figure 5 Measuring μA and mA current

% Scale of 4–20 mA

The % scale for 4–20 mA or 0–20 mA is calculated using its corresponding DC mA measurement. Meter will optimize the best resolution automatically as per the below table. The **RANGE** and bar graph is used for ranging 50 mA and 500 mA. The % scale for 4–20 mA or 0–20 mA is set to two ranges as follows:

% (0–20 or 4–20 mA) Always auto range	DC mA Auto or manual range
999.99%	50 mA, 500 mA
9999.9%	

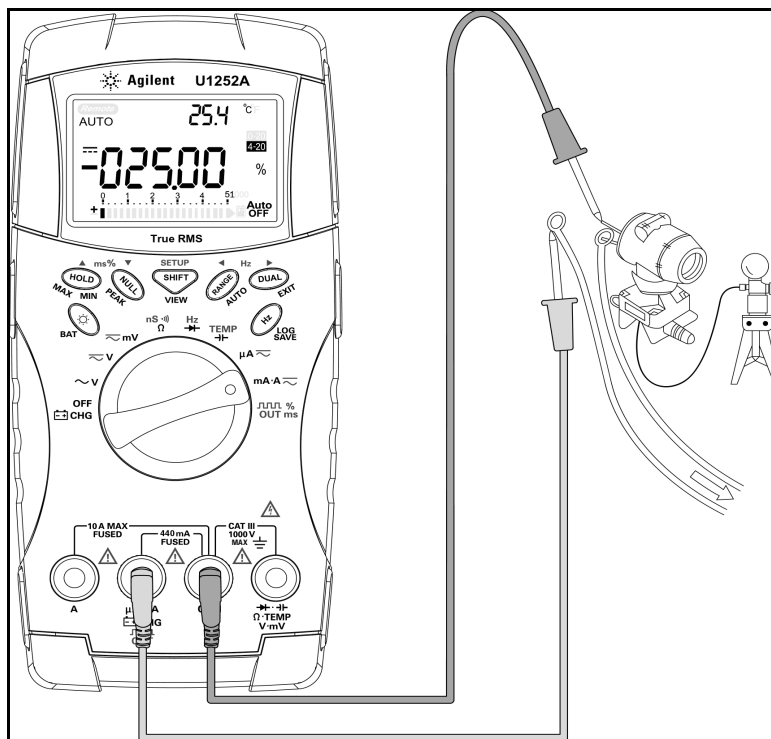

Figure 6 Measuring scale of 4-20 mA

A measurement

- 1 Set the rotary switch to mA·A \sim .
- 2 Connect the red and black test leads to 10A input terminal A and COM respectively. The meter is set to A measurement automatically when the red test lead is plugged into the A terminal.

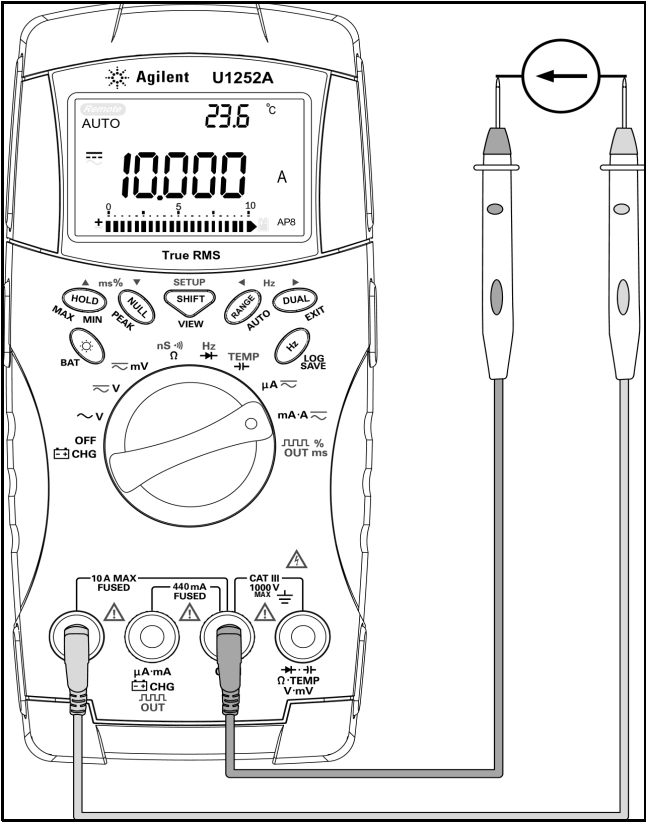





Figure 7 A measurement

Frequency Counter

WARNING

Use the frequency counter for low voltage application. Never use the frequency counter on line power system.

- Hz
- 1 Set the rotary switch to .
 - 2 Push  to select the Frequency counter (Hz) function. “-1-“ on the secondary display means the input signal frequency is divided by 1. This accommodates for higher frequency range of up to 2 MHz.
 - 3 Connect the red and black test leads to input terminals **V** and **COM** respectively.
 - 4 Probe the test points and read the display.
 - 5 If the reading is unstable or zero, push  to select division of input signal frequency by 100. This accommodates for higher frequency range of up to 20 MHz.
 - 6 The signal is out of specification if the reading is still unstable after Step 5.

While the secondary display shows “-1-“, you may scroll through the pulse width (ms), duty cycle (%) and frequency (Hz) measurements by pushing .

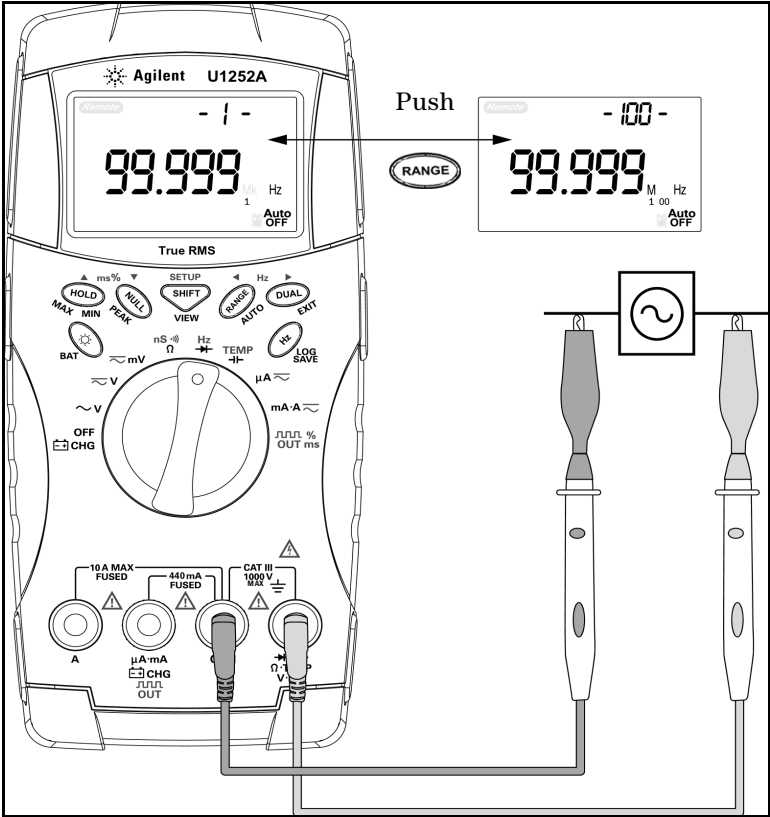

Figure 8 Measuring frequency

Measuring Resistance, Conductance and Testing Continuity

CAUTION

Disconnect circuit power and discharge all high-voltage capacitors before measuring resistance to prevent possible damage to the meter or the device under test.

- 1 Set the rotary switch to Ω \bullet Ω nS.
- 2 Connect the red and black test leads to input terminals Ω and **COM** respectively.
- 3 Probe the test points (by shunting the resistor) and read the display.

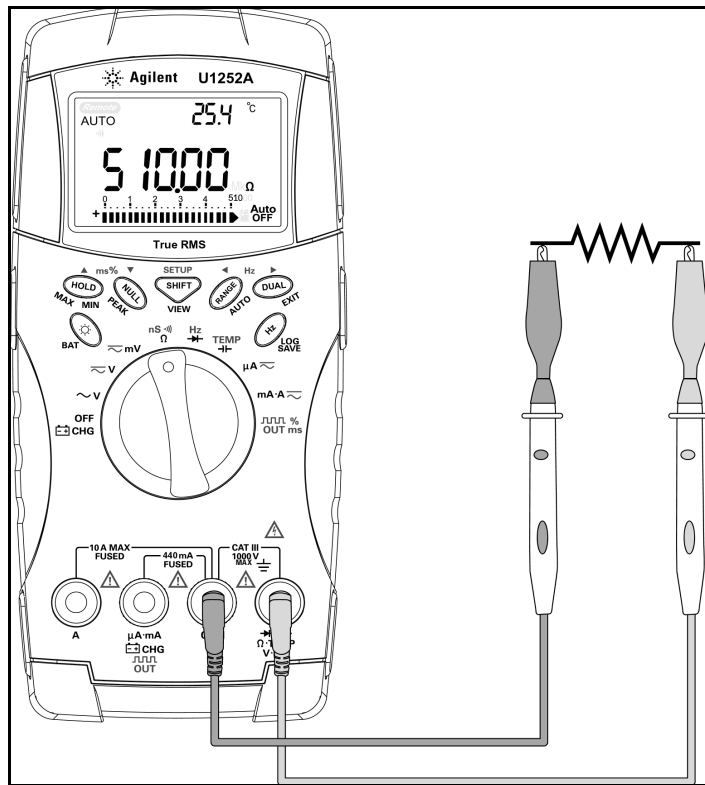



Figure 9 Measuring resistance

- 4 Push  to scroll through audible continuity, conductance and resistance tests as shown in **Figure 10**.

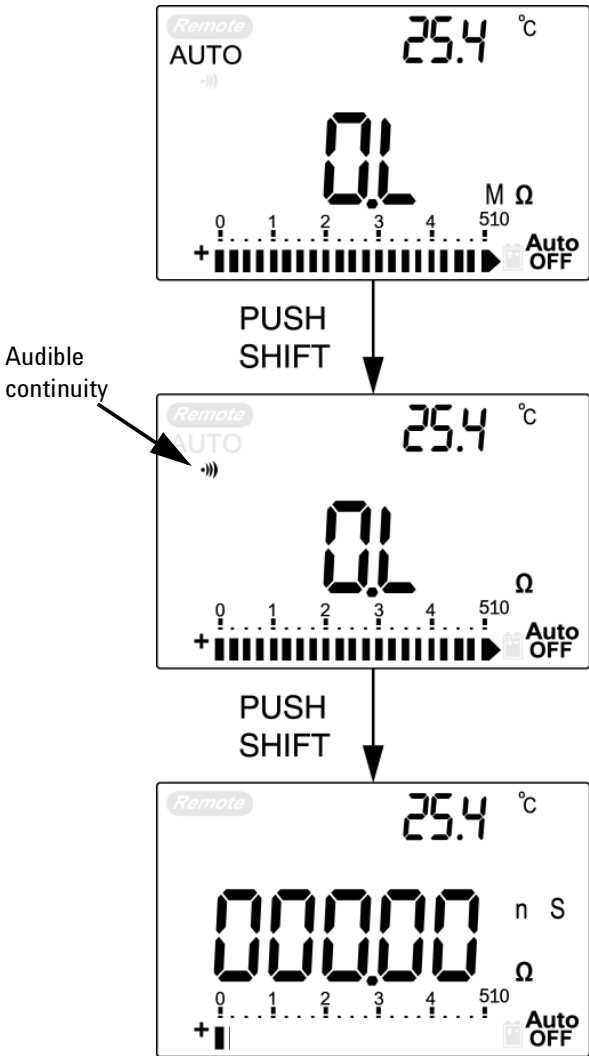

Figure 10 Audible continuity, conductance and resistance test.

2 Making Measurements

In the range of 0–500 Ω , the beeper will sound if the resistance value falls below 10 Ω . For other ranges, the beeper will sound if the resistance falls below the typical values indicated in the table below.

Measuring range	Beeper sounds when
500.00 Ω	< 10 Ω
5.0000 k Ω	< 100 Ω
50.000 k Ω	< 1 k Ω
500.00 k Ω	< 10 k Ω
5.0000 M Ω	< 100 k Ω
50.000 M Ω	< 1 M Ω
500.00 M Ω	< 10 M Ω

Conductance measurement eases measurement of very high resistance of up to 100 G Ω . As high-resistance readings are susceptible to noise, you can capture average readings via the Dynamic Recording mode. See **Figure 17** on Page 59.

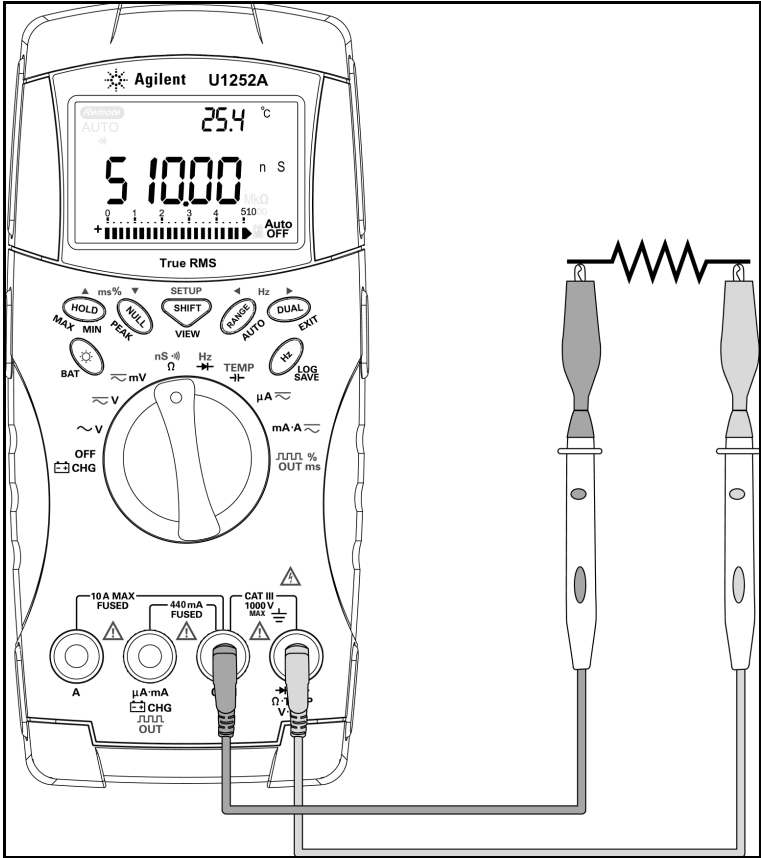



Figure 11 Conductance measurement

Testing Diodes

CAUTION

Disconnect circuit power and discharge all high-voltage capacitors before testing diodes to prevent possible damage to the meter.

To test a diode, turn the circuit power off, and remove the diode from the circuit. After that, proceed as follows:

- 1 Set the rotary switch to .
- 2 Connect the red and black test leads to input terminals  and **COM** respectively.
- 3 Use the red probe lead on the positive terminal (anode) of the diode and the black probe lead on the negative terminal (cathode).

NOTE

The cathode is the side with band(s).

- 4 Read the display.

NOTE

The meter can display diode forward bias of up to approximately 2.1 V. Typical diode forward bias is between the range of 0.3 to 0.8 V range.

- 5 Reverse the probes and measure the voltage across the diode again. Diode test result is based on the following:
 - Diode is considered good if the meter displays “OL” in reverse bias mode.
 - Diode is considered shorted if the meter displays approximately 0 V in both forward and reverse bias modes, and the meter beeps continuously.
 - Diode is considered open if the meter displays “OL” in both forward and reverse bias modes.

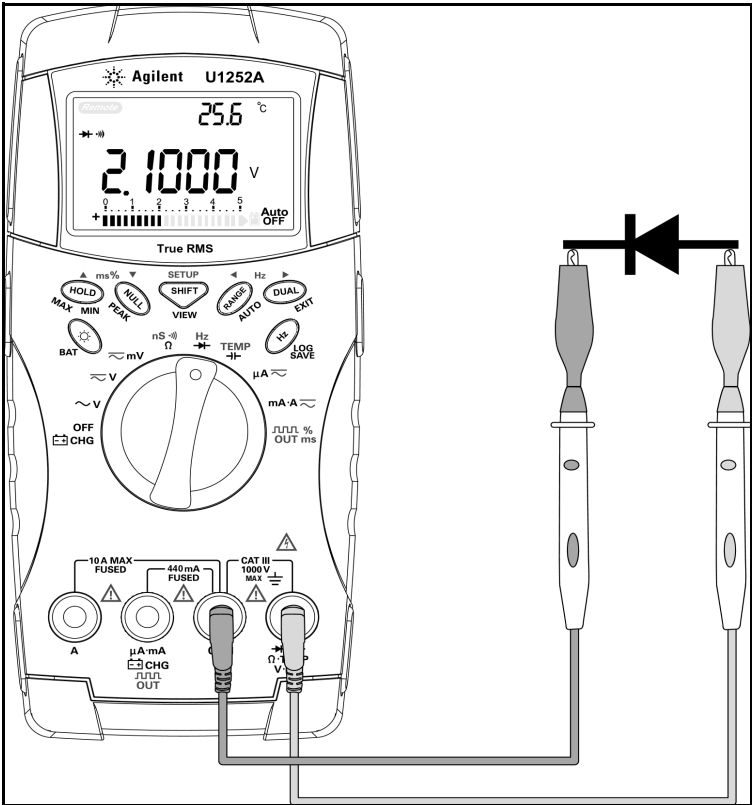

Figure 12 Measuring forward bias of diode

2 Making Measurements

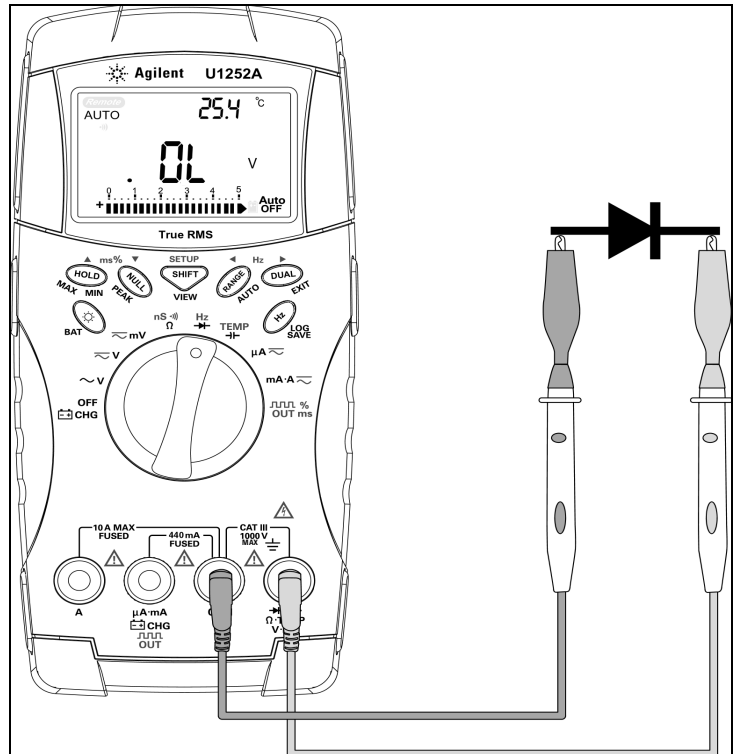

Figure 13 Measuring reverse bias of diode

Measuring Capacitance

CAUTION

Disconnect circuit power and discharge all high-voltage capacitors before measuring capacitance to prevent possible damage to the meter or the device under test. To confirm that capacitors have discharged, use the DC voltage function.



The meter measures capacitance by charging the capacitor with a known current for a period of time, measuring the voltage and then calculating the capacitance. Larger the capacitors, longer the charging time.

Measuring tips:

- For measuring capacitances greater than 10,000 μ F, discharge the capacitor first, then select a suitable range for measurement. This will speed up measuring time in order to obtain the correct capacitance value.
- For measuring small capacitances, push  with the test leads open to subtract the residual capacitance of the meter and leads.

NOTE

 means capacitor is charging.  means capacitor is discharging.

- 1 Set the rotary switch to .
- 2 Connect the red and black test leads to input terminals  and **COM** respectively.
- 3 Use the red probe lead on the positive terminal of the capacitor while the black probe lead on the negative terminal.
- 4 Read the display.

Measuring Temperature

CAUTION

Do not bend the thermocouple leads at sharp angles. Repeated bending over a period of time can break leads.

The bead type thermocouple probe is suitable for making temperature measurements between $-20\text{ }^{\circ}\text{C}$ to $200\text{ }^{\circ}\text{C}$ in Teflon compatible environments. Above this temperature, probes may emit toxic gas. Do not immerse this thermocouple probe in liquids. For best results, use a thermocouple probe designed for each application – an immersion probe for liquid or gel, an air probe for air measurements. Observe the following measuring techniques:

- Clean the measurement surface and make sure the probe is securely touching the surface. Remember to disable the applied power.
- When measuring above ambient temperature, move the thermocouple along the surface until you get the highest temperature reading.
- When measuring below ambient temperature, move the thermocouple along the surface until you get the lowest temperature reading.
- Place the meter in the operating environment for at least 1 hour as using non-compensation transfer adaptor with miniature thermal probe.
- For quick measurement, use the $0\text{ }^{\circ}\text{C}$ compensation to see the temperature variation of the thermocouple sensor. The $0\text{ }^{\circ}\text{C}$ compensation assists you in measuring relative temperature immediately.

- 1 Turn the rotary switch to **TEMP** position.
- 2 Push  to select temperature measurement.

- 3 Plug the thermocouple adapter (with the thermocouple probe connected to it) into input terminals **TEMP** and **COM**.
- 4 Touch the measurement surface with the thermocouple probe.
- 5 Read the display.

If you are working in a varied environment, where ambient temperature is not constant, do the following:

- 1 Push **DUAL** to select 0 °C compensation. This allows a quick measurement of the relative temperature.
- 2 Avoid contact between the thermocouple probe and the measurement surface.
- 3 After a constant reading is obtained, push **NULL** to set the reading as the relative reference temperature.
- 4 Touch the measurement surface with the thermocouple probe.
- 5 Read the display for the relative temperature.

2 Making Measurements

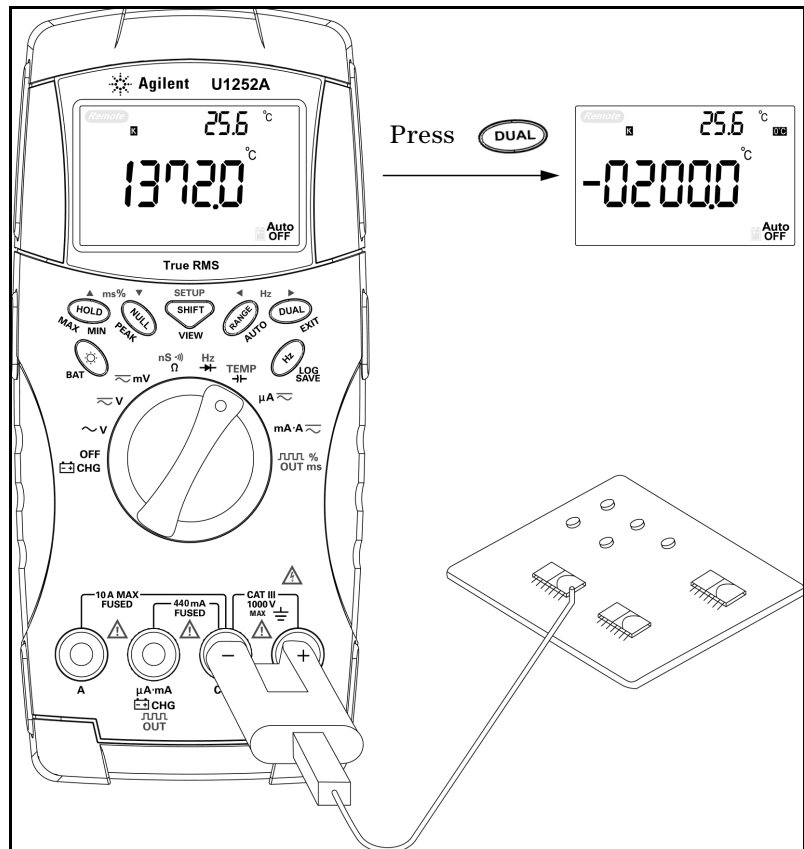

Figure 14 Surface temperature measurement

Alerts and Warning During Measurement

Overload Alert

WARNING

For your safety, please be aware of the alert. When you are alerted, just remove the test leads from the measuring source.

The meter provides an overload alert for voltage measurement in both auto and manual range modes. The meter beeps periodically once the measuring voltage exceeds 1010 V. For your safety, please be aware of this alert.

Input Warning

The meter sounds an alerting beep when the test lead is inserted to the **A** input terminal but the rotary switch is not set to the corresponding **mA.A** location. The primary display indicates a flashing “**A-Err**” until the test lead is removed from the **A** input terminal. See **Figure 15**.



Figure 15 Input terminal warning

Charge Terminal Alert



The meter sounds an alerting beep when the CHG terminal detects a voltage level of more than 5 V and the rotary switch is not set to the corresponding CHG^{OFF} location. The primary display indicates a flashing “Ch.Err” until the lead is removed from CHG input terminal. See **Figure 16**.



Figure 16 Charge terminal alert

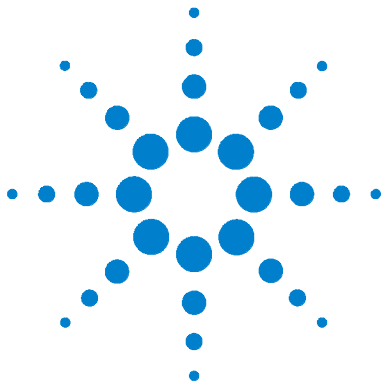

3 Features and Functions

Dynamic Recording	58
Data Hold (Trigger Hold)	60
Refresh Hold	61
NULL (Relative)	63
Decibel Display	65
1 ms Peak Hold	67
Data Logging	69
Manual Logging	69
Interval Logging	71
Reviewing Logged Data	73
Square Wave Output (for U1252A)	75
Remote Communication	80





This chapters contains detailed information on the features and functions that are available in this meter.



Dynamic Recording

The Dynamic Recording mode can be used to detect intermittent turn on or turn off voltage or current surges and verify measuring performance without the user being present during that particular period of time. At the same time, you can take readings simultaneously while performing other task.

The average reading is useful for smoothing out unstable inputs, estimating the percentage of time a circuit is operated, and verifying circuit performance. Time lapse is shown on the secondary display. The maximum time is 99,999 seconds. When this maximum time is exceeded, "OL" is indicated on the display.

- 1 Push  for more than 1 second to enter Dynamic Recording mode. Meter is now in continuous mode or non-data hold (non-trigger) mode. "MAXMINAVG" and present value of measurement are displayed. The beeper sounds when a new maximum or minimum value is recorded.
- 2 Push  to cycle through maximum, minimum, average and present readings. The **MAX**, **MIN**, **AVG** and **MAXMINAVG** light up correspondingly to the displayed readings.
- 3 Push  or  for more than 1 second to exit Dynamic Recording mode.
 - Push  to restart dynamic recording.
 - The average value is the true average of all measured values taken in the Dynamic Recording mode. If an overload is recorded, the averaging function will stop and the average value becomes "OL"(overload). **Auto OFF** is disabled in Dynamic Recording mode.

NOTE

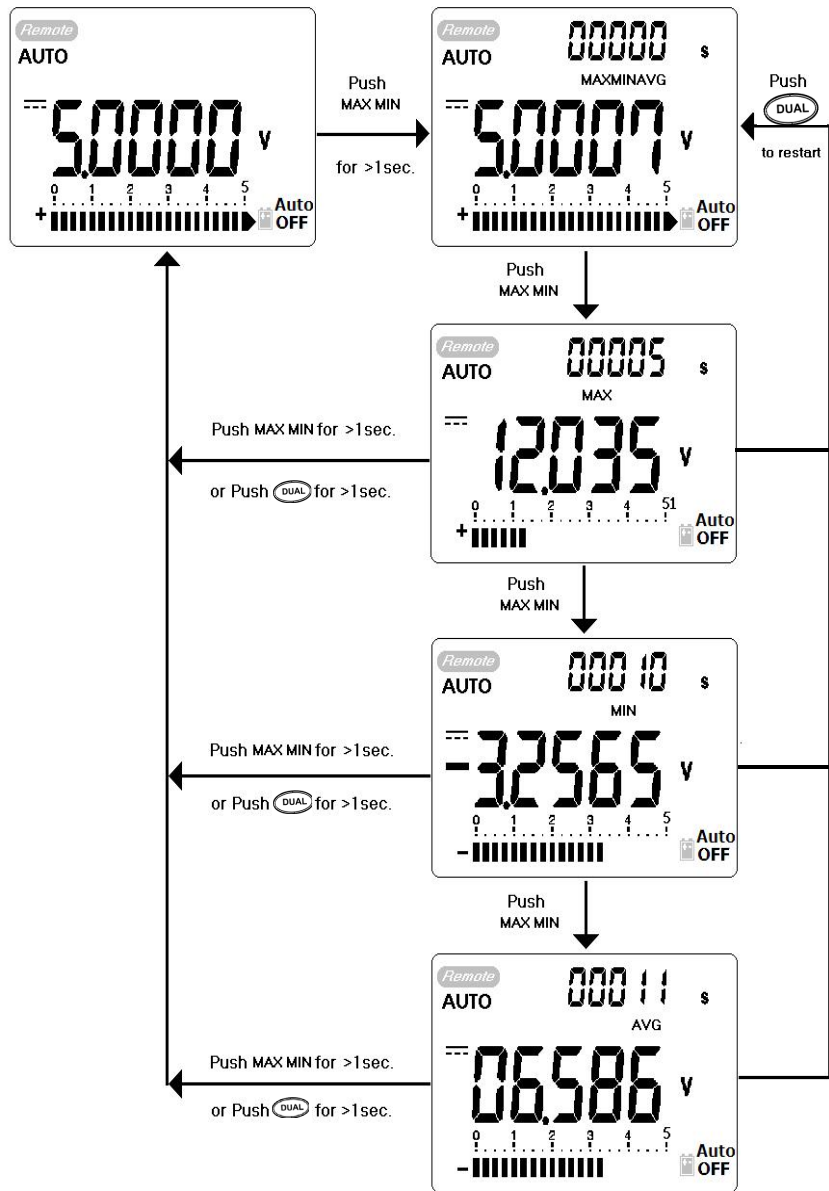

Figure 17 Dynamic recording mode operation

Data Hold (Trigger Hold)

The data hold function allows operators to freeze the displayed digital value.

- 1 Push **HOLD** to freeze the displayed value and to enter manual trigger mode. **TRIG HOLD** is displayed.
- 2 Push **HOLD** to trigger the freeze of the next value being measured. **TRIG** flashes before the new value is updated onto the display.
- 3 Push and hold **HOLD** or **DUAL** for more than 1 second to quit this mode.

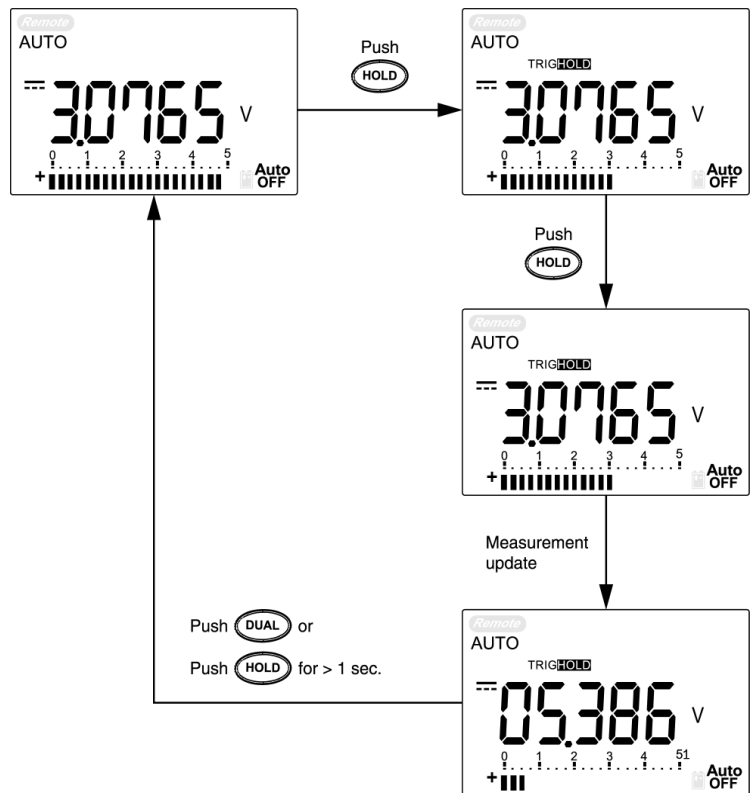



Figure 18 Data hold mode operation

Refresh Hold

The hold function allows operators to hold the displayed digital value. The bar-graph is not held, fix proportional to real measurement value. You can use the setup mode to enable the **Refresh Hold** when you are working on a difficult measuring field. This function will auto trigger or update Hold value with new measuring value, and sound a tone to remind user.

Press  button to enter Refresh Hold mode. The present value will be held, and the sign of **HOLD** will be lit. It will be ready to hold new measuring value once the variation of measuring value exceeds the setting of variation count, and the sign of **HOLD** is flashed. The hold value will be updated until the measuring value is stable, and then it stops flashing and lit **HOLD** and sound a tone to remind user. Press  again to disable this function.

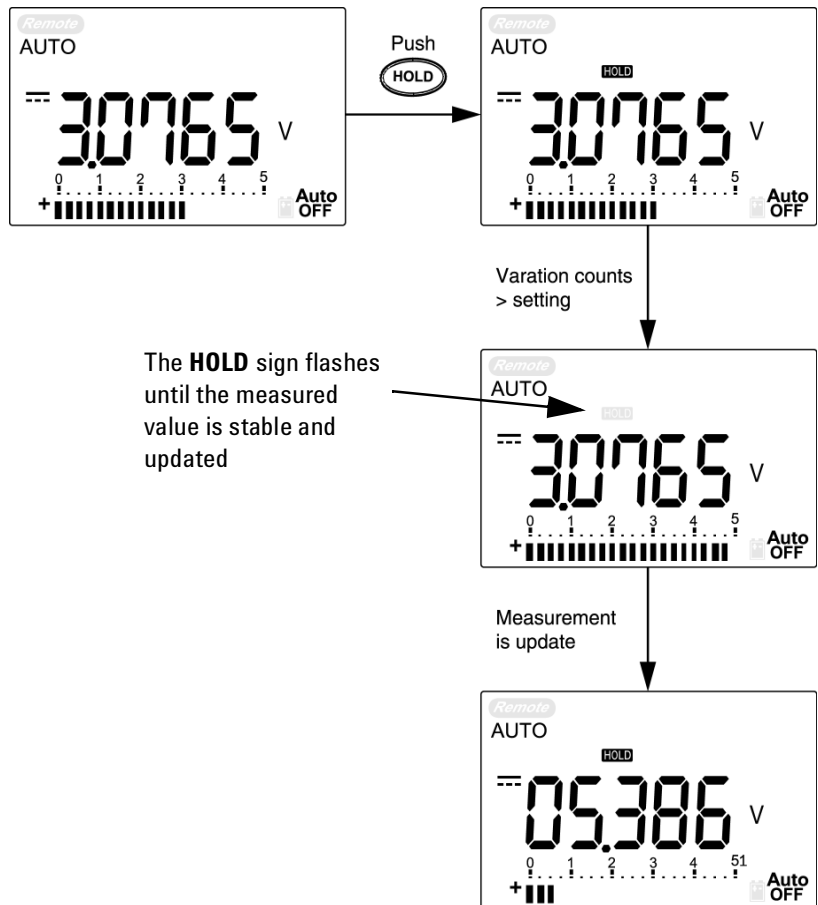

Figure 19 Refresh hold mode operation

NOTE

- For voltage and current measurements, the holding value will not be updated if the reading is below 500 counts.
- For resistance and diode measurements, the holding value will not be updated if the reading is in “**OL**” (open state).
- The holding value may not be updated when the reading does not reach the stable state for all measurements.

NULL (Relative)

The NULL function subtracts a stored value from the present measurement and displays the difference between the two.

- 1 Push **NULL** to store the displayed reading as the reference value to be subtracted from subsequent measurements and to set the display to zero. **NULL** is displayed.

NOTE

Null can be set for both auto and manual range setting, but not in the occurrence of an overload.

- 2 Push **NULL** to see the stored reference value. **NULL** flashes for 3 seconds before the display returns to zero.
- 3 To exit this mode, push **NULL** while **NULL** is flashing on the display.

NOTE

- When in resistance measurement, the meter reads a non-zero value due to the presence of test leads. Use the Null function to zero-adjust the display.
- When in DC voltage measurement, the thermal effect will influence the accuracy. Short the test leads and push **NULL** once the displayed value is stable in order to zero out the display.

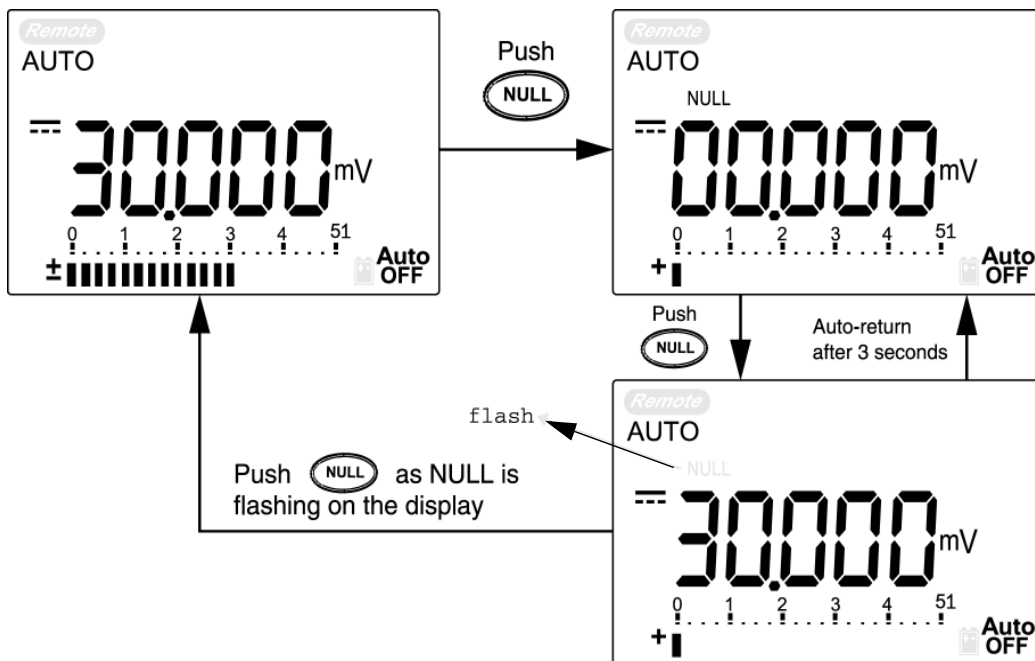

Figure 20 Null (relative) mode operation

Decibel Display

The dBm operation calculates the power delivered to a reference resistance relative to 1 mW, and can be applied to DC V, AC V and AC + DC V measurements for decibel conversion. Voltage measurement is converted to dBm by using the following formula:

$$\text{dBm} = 10 \log_{10} \left[\frac{1000 \times (\text{measuring value})^2}{\text{reference impedance}} \right]$$

The reference resistance may be selected from 1~9999Ω in Setup mode. Default value is 50Ω.

The decibel of voltage is calculated with respect to 1 V. The formula is according to the voltage measurement below:

$$\text{dBV} = 20 \log_{10} \text{Vin}$$

- 1 At $\sim V$, $\sim V$ or $\sim mV$ rotary switch position, push  to scroll to dBm measurement on the primary display. AC voltage measurement is indicated on the secondary display.

NOTE

If rotary switch is at “~ V” position, push  to switch between dBV and dBm measurements. The dBm or dBV measurement can be selected at ACV position, the selection will be the reference for other voltage measurement.

- 2 Push  for more than 1 second to exit this mode.

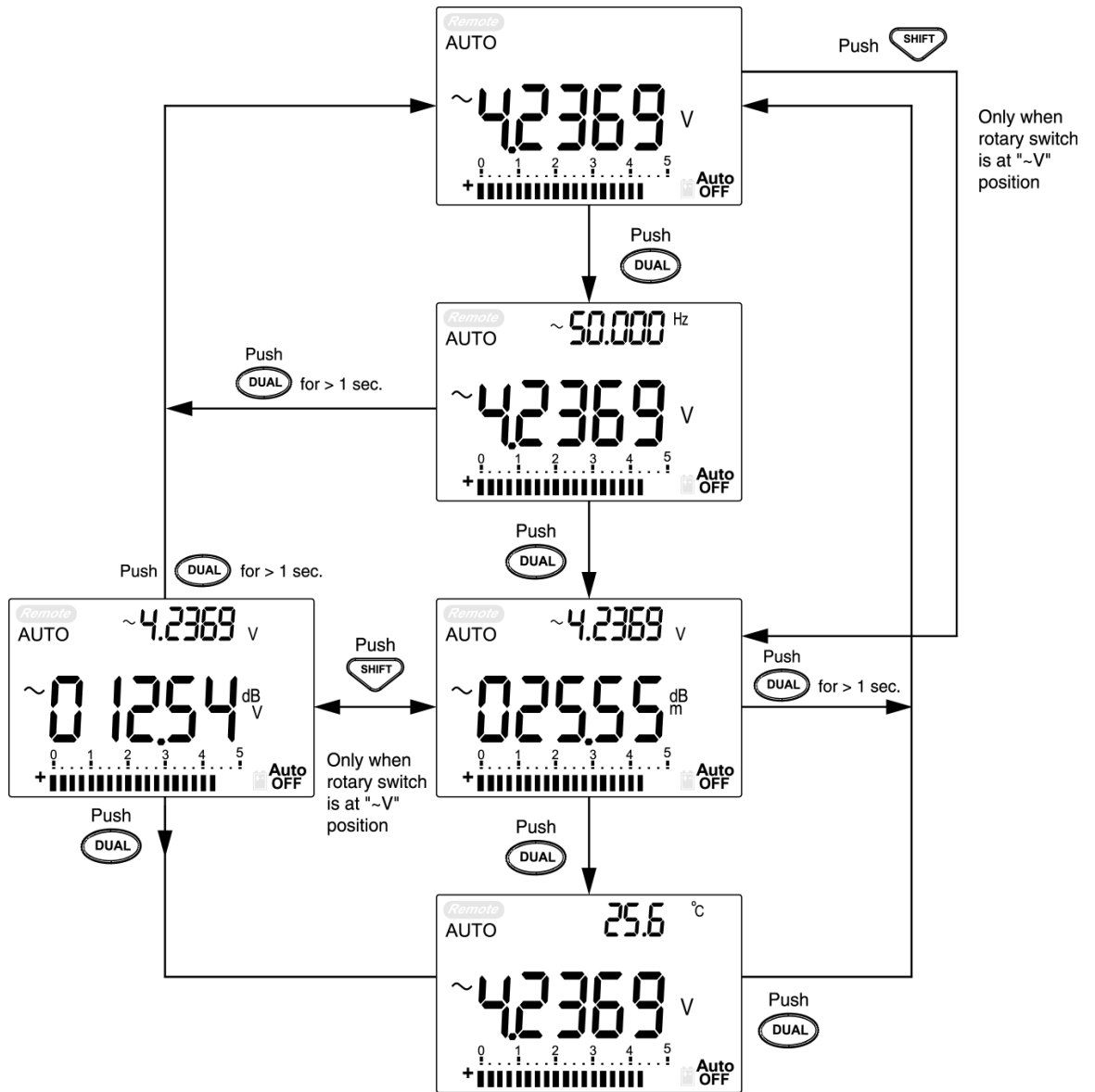



Figure 21 dBm/dBV display mode operation



1 ms Peak Hold



This function allows the measurement of half-cycle peak voltage for analysis of components such as power distribution transformers and power factor correction capacitors. The peak voltage obtained can be used to determine the crest factor:

$$\text{Crest factor} = \text{Peak value} / \text{True RMS value}$$

- 1 Push  for more than 1 second to toggle 1 ms Peak Hold mode ON / OFF.
- 2 Push  to scroll through maximum and minimum peak readings. **HOLD MAX** indicates maximum peak, while **HOLD MIN** indicates minimum peak.

NOTE

- If the reading is "OL", push  to change measuring range and to re-start peak-recording measurement.
- If you need to re-start peak recording, push 

- 3 Push  or  for more than 1 second to exit this mode.
- 4 According to measurements in **Figure 22**, the crest Factor will be $2.5048 / 1.768 = 1.416$.

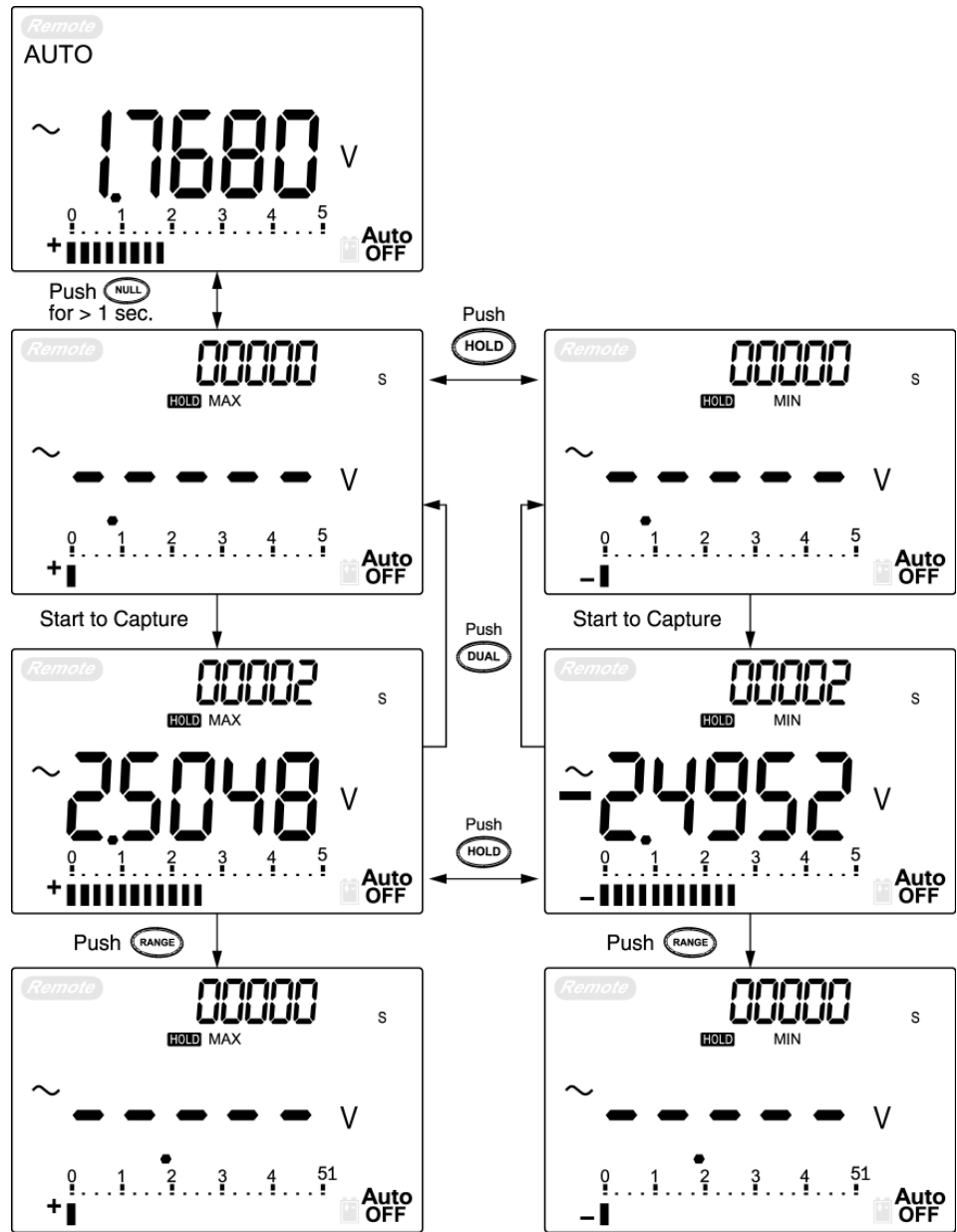





Figure 22 1 ms peak hold mode operation

Data Logging

Data logging function eases recording of test data for future review or analysis. Since data is stored in non-volatile memory, the data remains saved when the meter is turned OFF or battery is being changed. The two options offered are hand (manual) logging and interval (automatic) logging functions. Data logging records the value on primary display only.

Manual Logging

Hand (Manual) logging can be specified in Setup mode.

- 1 Push  for more than 1 second to store the present value and function on primary display to memory.  and the logging index are indicated. The logging index flashes on the secondary display for 3 seconds before returning to normal display.
- 2 Push  again for the next value that you want to save into memory.

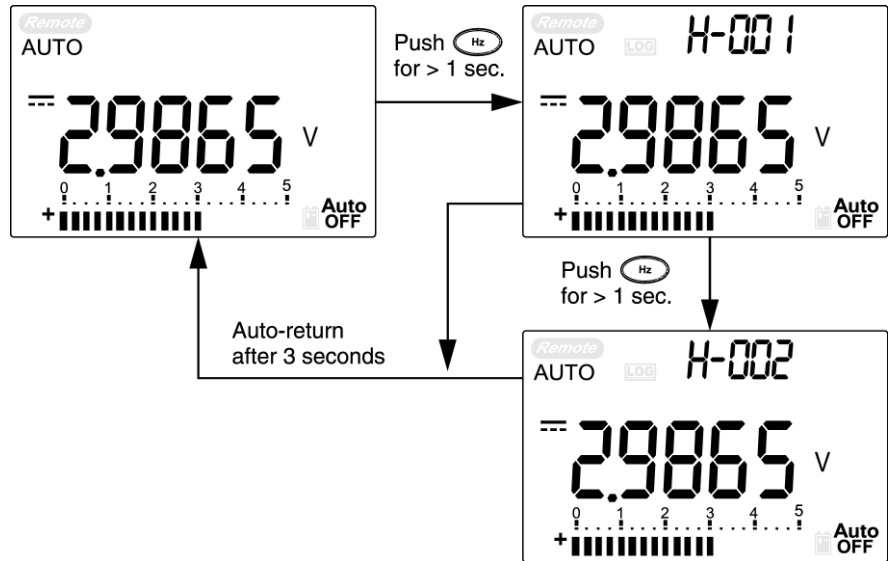

Figure 23 Hand (Manual) logging mode operation

NOTE

Maximum data that can be stored is 100 entries. When the 100 entries are filled, "FULL" is indicated on the secondary display, as shown in Figure 24.

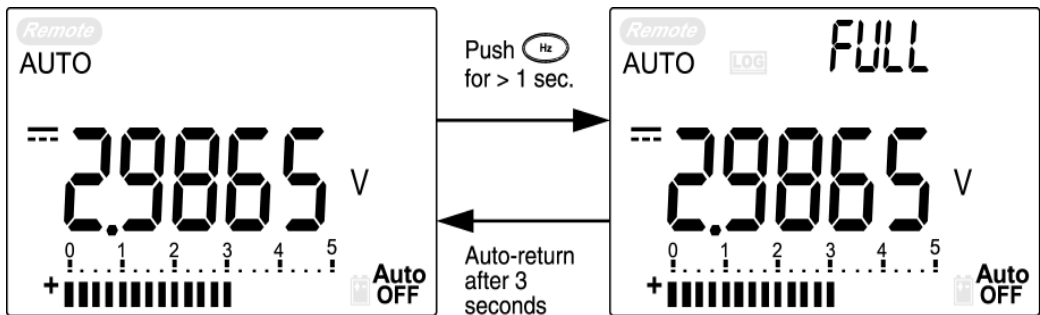



Figure 24 Full Log

- 3 Push  for more than 1 second to exit this mode.

Interval Logging

Interval (automatic) logging mode can be specified in Setup mode.

- 1 Push  for more than 1 second to store the present value and function on primary display to memory. **LOG** and the logging index are indicated. The reading automatically logs into the memory by every interval set in Setup mode.

NOTE

The maximum data that can be stored is 200 entries. When the 200 entries are filled, "**FULL**" is indicated on the secondary display.

- 2 Push  for more than 1 second to exit this mode.

NOTE

When interval (automatic) logging is enabled, all keypad operation is disabled, except for LOG function.

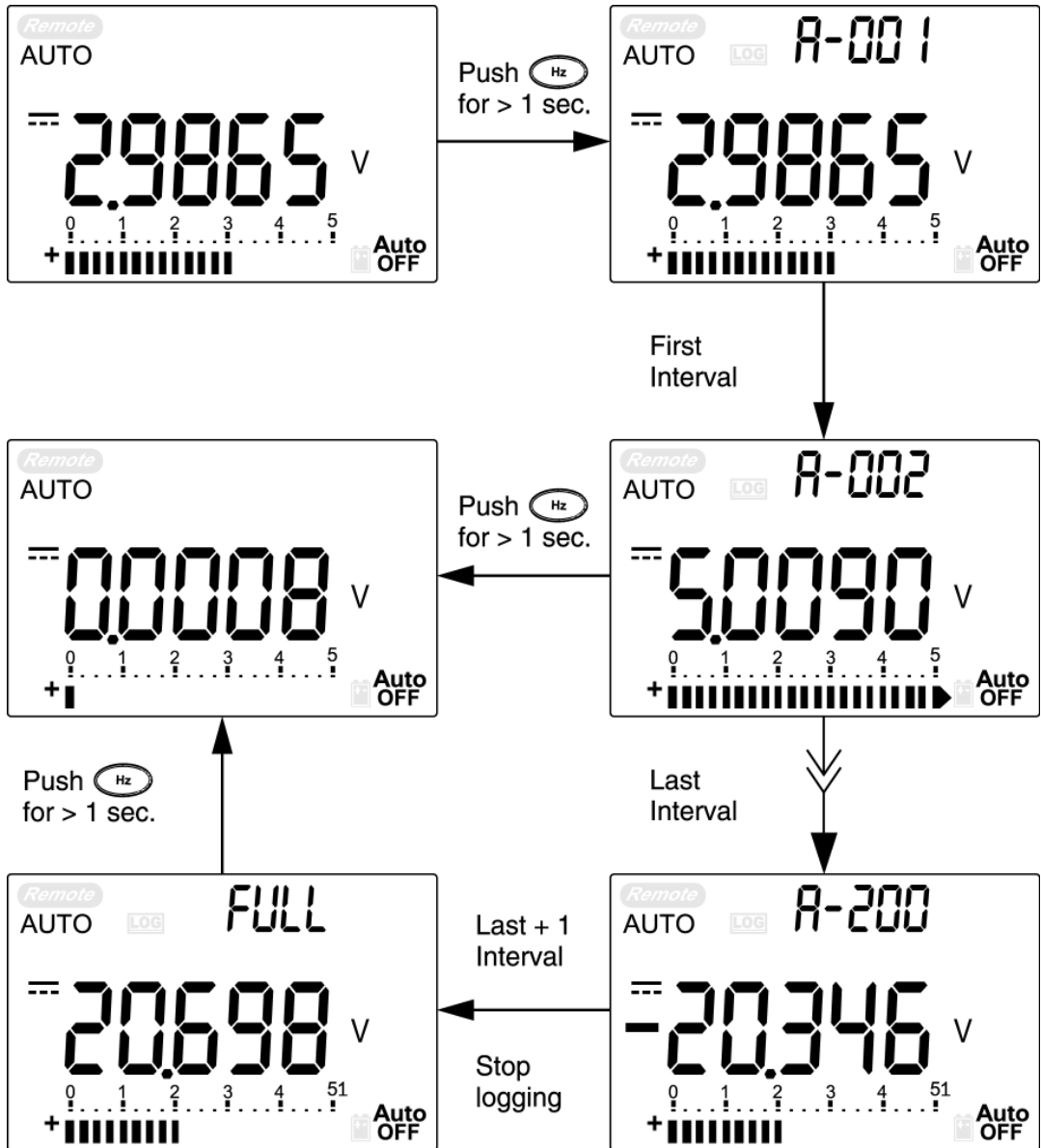











Figure 25 Interval (Automatic) logging mode operation

Reviewing Logged Data

- 1 Push  for more than 1 second to enter Log Review mode. Last recorded entry and last logging index are displayed.
- 2 Push  to switch between hand (manual) and interval (automatic) logging review mode.
- 3 Push  to ascend or  to descend through logged data. Press  to select first record and press  to select the last record for quick navigation.
- 4 Push  for more than 1 second at the respective Log Review mode to clear logged data.
- 5 Push  for more than 1 second to exit mode.

During data review in either manual or interval logging mode, push  button for more than one second to clear all logging values, respectively.

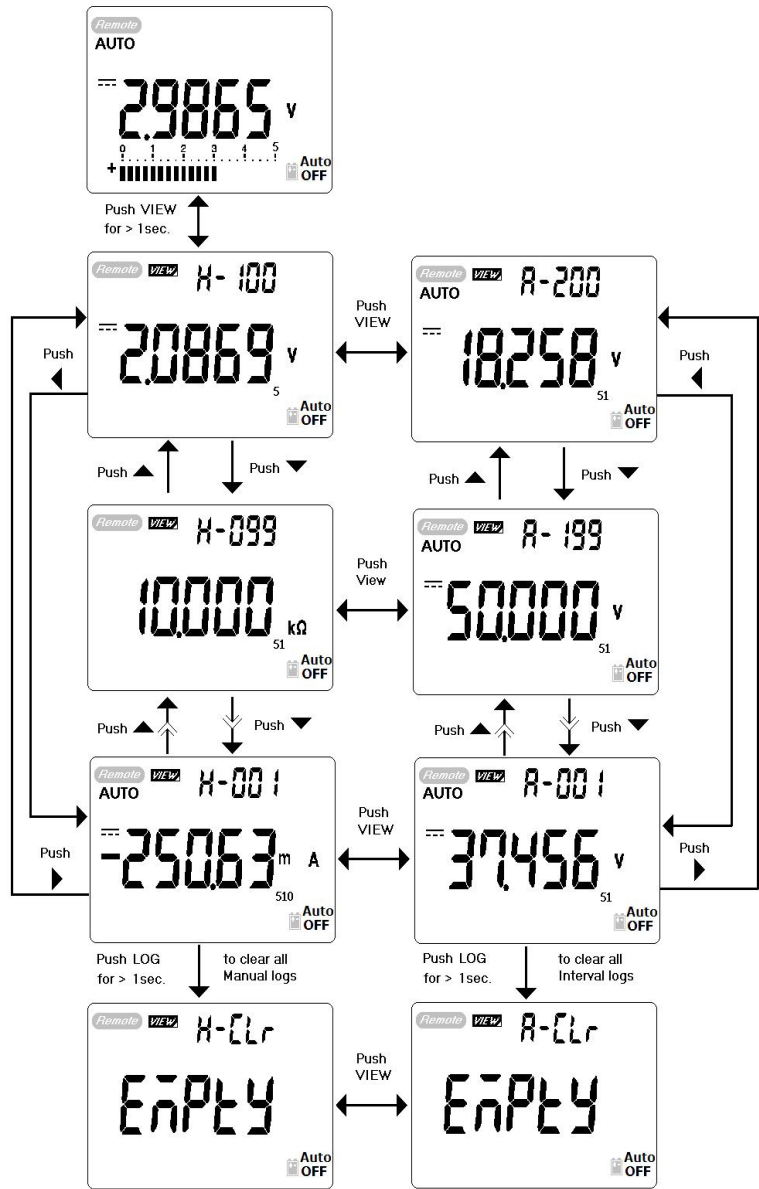

Figure 26 Log review mode operation

Square Wave Output (for U1252A)

Square wave output is a unique function for many applications, such as PWM (Pulse Width Modulation) output, adjustable voltage control, and synchronic clock (baud rate generator). You can also use this function to check and calibrate flow-meter displays, counters, tachometers, oscilloscopes, frequency converter, frequency transmitter and other frequency input devices.

- 1 Turn the rotary switch to $\overline{\text{OUT}}$ position. Default display setting is 600 Hz on secondary display and 50% duty cycle on primary display.
- 2 Push ◀ or ▶ to scroll through the available frequencies (there are 28 frequencies to choose from):

Frequency (Hz)
0.5, 1, 2, 5, 10, 15, 20, 25, 30, 40, 50, 60, 75, 80, 100, 120, 150, 200, 240, 300, 400, 480, 600, 800, 1200, 1600, 2400, 4800

NOTE

Pushing  is the same as pushing ▶ .

- 3 Push  to select duty cycle (ms) on primary display.
- 4 Push ▲ or ▼ to adjust the duty cycle. Duty cycle can be set for 256 steps and each step is 0.390625%. The display only indicates the best resolution with 0.001%.

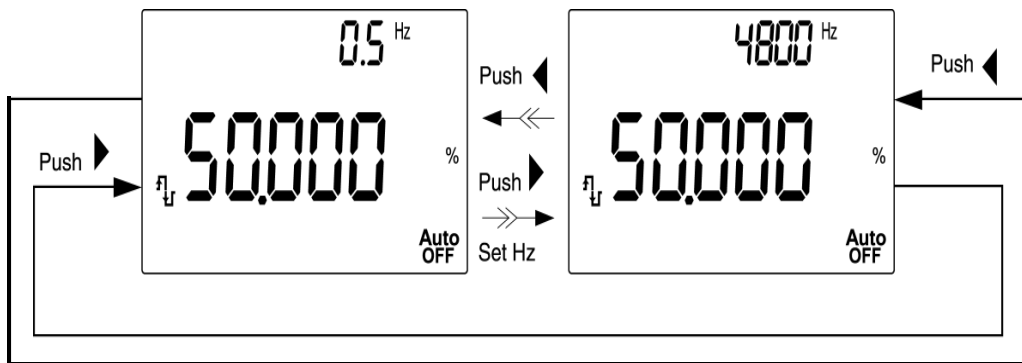





Figure 27 Frequency adjustment for square wave output

- 5 Push  to select pulse width (%) on primary display.
- 6 Push  or  to adjust the pulse width. The pulse width can be set for 256 steps and each step is $1 / (256 \times \text{Frequency})$. The display range auto-adjusts in the range of 9.9999~9999.9 ms.

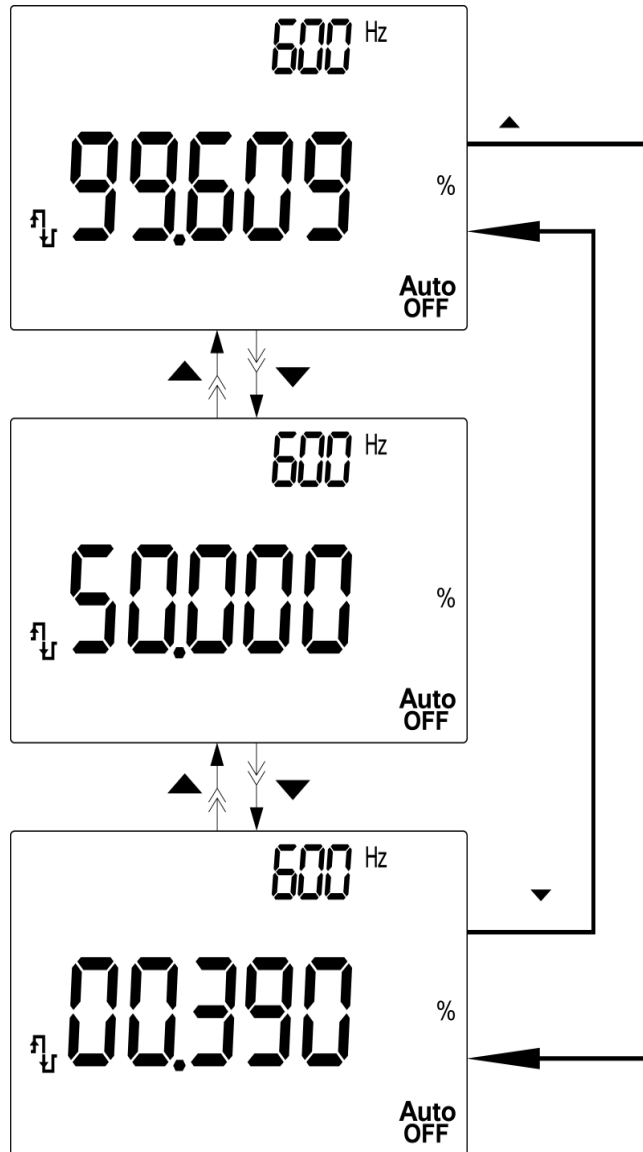

Figure 28 Duty cycle adjustment for square wave output

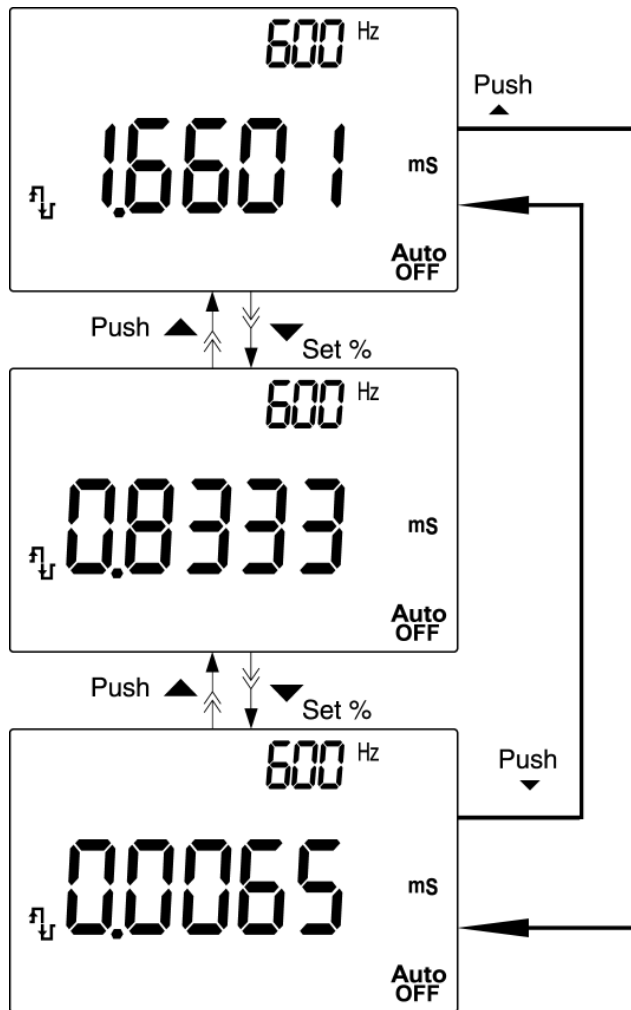

Figure 29 Pulse width adjustment for Square Wave

Remote Communication

The meter has a bi-directional (full duplex) communication capability that eases data storing from the meter to PC. The necessary accessory for this is the optional USB-RS232 together with the application software in the accompanying CD.

Refer to the “Agilent GUI Software Helpfile” in the CD for instructions on how to perform the PC-meter remote communication.

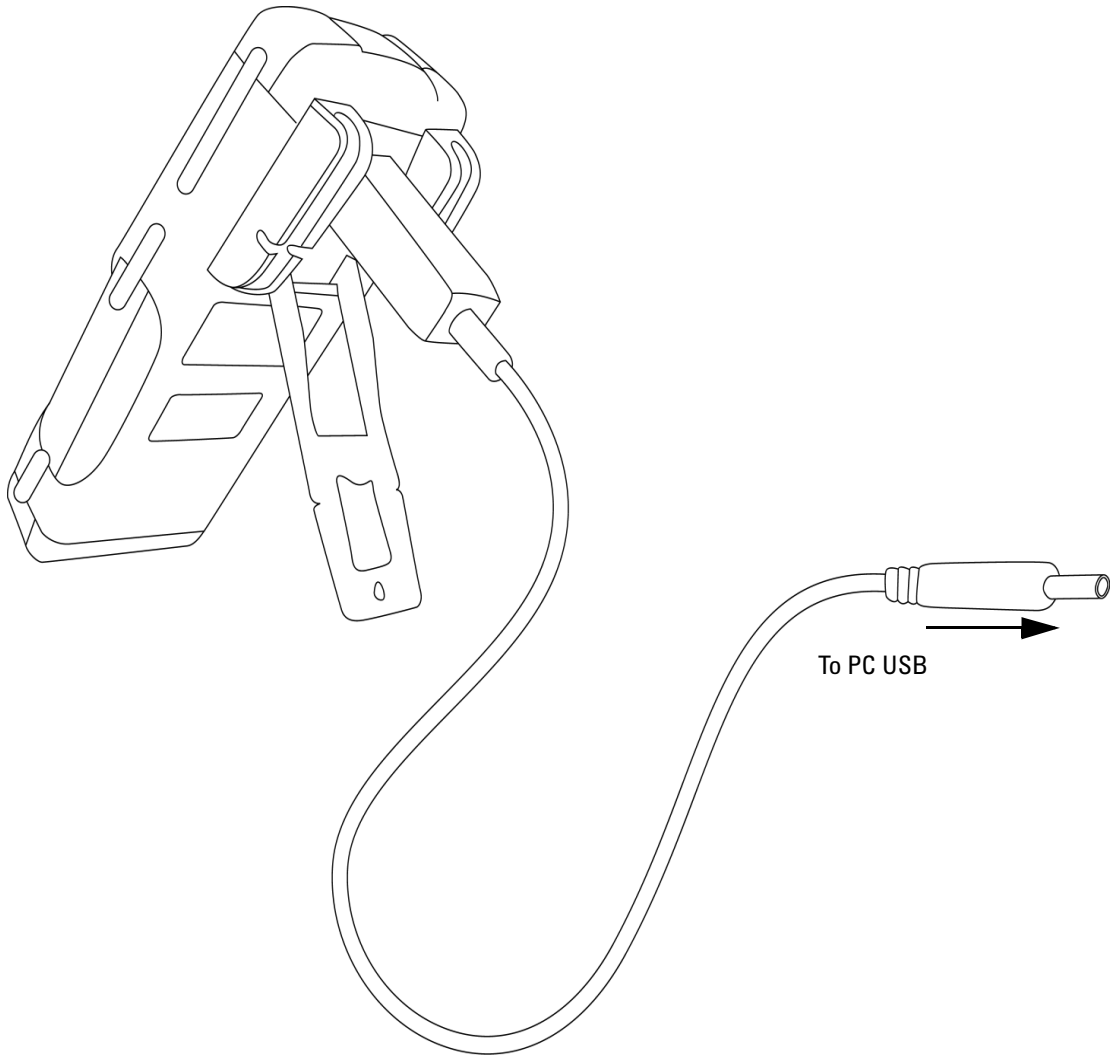
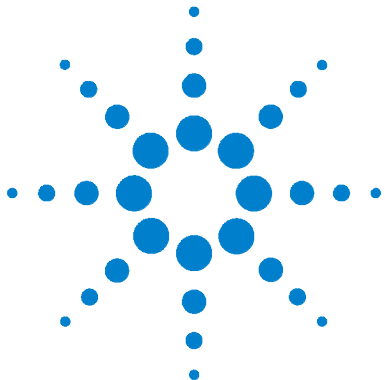

Figure 30 Cable Connection for remote communication



4 Changing The Default Setting

Selecting Setup Mode	82
Setting Data Logging Mode	86
Setting Thermocouple Types (for U1252A)	87
Setting Reference Impedance for dBm Measurement	88
Setting Minimum Frequency Measurement	89
Setting Temperature Unit	90
Setting Auto Power Saving Mode	92
Setting % Scale Readout	94
Setting Beep Frequency	95
Setting Backlit Timer	96
Setting Baud Rate	97
Setting Parity Check	98
Setting Data Bit	99
Setting Echo Mode	100
Setting Print Mode	101
Returning to Default Factory Settings	102

This chapter describes on how to change the default setting of the handheld digital multimeter including data logging and other setting features.



Selecting Setup Mode

To enter Setup mode, perform the following steps:

1. Turn meter OFF.
2. From OFF position, push and hold  while turning the rotary switch to any non-OFF position.

NOTE

When you hear a beep, the meter is in Setup mode and you can release



To change a menu item setting in Setup mode, perform the following steps :









1. Push  or  to scroll through menu items.
2. Push  or  to scroll through available settings. See Table 3, “Available setting options in Setup mode,” for details of available options.
3. Push  to save changes. These parameters remain in the non-volatile memory.
4. Push  for more than 1 second to exit Setup mode.



Table 3 Available setting options in Setup mode

Menu item		Available setting options		Default factory setting
Display	Description	Display	Description	
rHoLd ⁽¹⁾	Refresh Hold	OFF	Enables Data Hold (manual trigger)	500
		100–1000	Sets variation count that determines Refresh Hold (auto trigger)	
d-LoG	Data logging	Hand	Enables manual data logging	Hand
		1–9999 s ⁽²⁾	Sets interval for automatic data logging	
t.CoUP	Thermocouple	tYPE	Sets thermocouple type to K-type	tYPE
		tYPE ⁽³⁾	Sets thermocouple type to J-type	
rEF	Reference impedance for dBm measurement	1–9999 Ω ⁽²⁾	Sets reference impedance for dBm measurement	50 Ω
FrEq	Minimum frequency that can be measured	0.5 Hz, 1 Hz, 2 Hz, 5 Hz	Sets minimum frequency that can be measured	0.5 Hz
APF	Auto power off	1–99 m	Sets timer for auto power off	10 m
		OFF	Disables auto power off	
PErnt	Percentage scale	0–20 mA, 4–20 mA	Sets % scale readout	4–20 mA
bEEP	Frequency of beep sound of meter	2400 Hz, 1200 Hz, 600 Hz, 300 Hz	Sets frequency of beep sound of meter	2400 Hz
		OFF	Disables beep sound of meter	
b-Lit	Backlit display	1–99 s	Sets timer for auto turn-off for backlit display	30 s
		OFF	Disables auto turn-off for backlit display	
bAUd	Baud rate	2400 Hz, 4800 Hz, 9600 Hz, 19200 Hz	Sets baud rate for remote communication (remote control with PC)	9600 Hz
PArY	Parity check	En, Odd, nOnE	Sets even, odd or no parity check for remote communication (remote control with PC)	nOnE
dAtAb	Data bits	7-bit, 8-bit	Sets data bit length for remote communication (remote control with PC)	8-bit
ECHO	Echo	ON, OFF	Enables return of characters to PC when set to ON	OFF

4 Changing The Default Setting

Print	Print	ON, OFF	Enables auto send of data to PC continuously when set to ON	OFF
Menu item		Available setting options		Default factory setting
Display	Description	Display	Description	
rESet	Reset	dEFAU	Enables reset of factory settings by pushing and holding  for more than 1 second	dEFAU
tEMP	Temperature ⁽⁴⁾	d-CF	Sets temperature measurement to °C but pushing  swaps display to °F	d-CF
		d-F	Sets temperature measurement to °F	
		d-FC	Sets temperature measurement to °F but pushing  swaps display to °C	
		d-C	Sets temperature measurement to °C	

NOTE

1. This is the first display once meter enters Setup mode.
2. For d-LoG and rEF menu items, push  to select the digit to be adjusted.
3. J-type thermocouple applies to U1252A.
4. To view tEMP menu item, push  for more than 1 second.

Setting Data Hold/Refresh Hold Mode

1. Set OFF to enable Data Hold mode (manual trigger by key or bus via remote control).
2. Set variation count within 100~1000 range to enable Refresh Hold mode (automatic trigger). When the variation of measuring value exceeds the setting of variation count, the Refresh Hold will be ready to trigger.

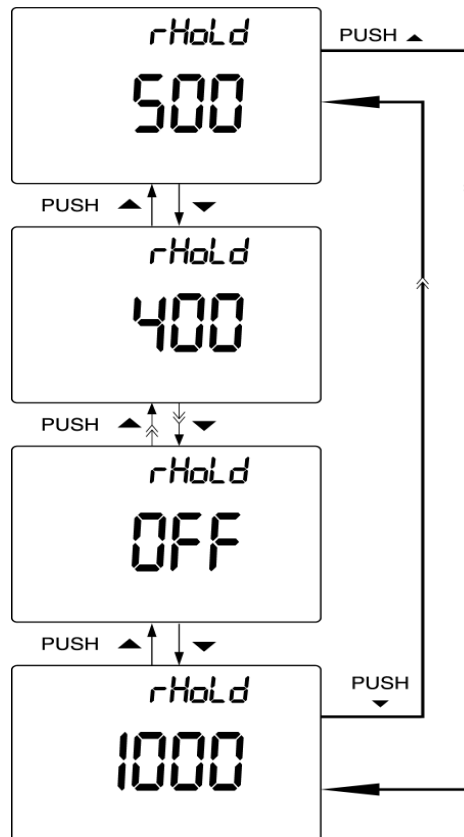

Figure 31 Data hold/Refresh hold setup

Setting Data Logging Mode

1. Set “Hand” to enable hand (manual) data logging mode.
2. Set interval within 0001~9999 seconds to enable interval (automatic) data logging mode.
3. Push ◀ or ▶ to switch between manual and interval data logging setup.

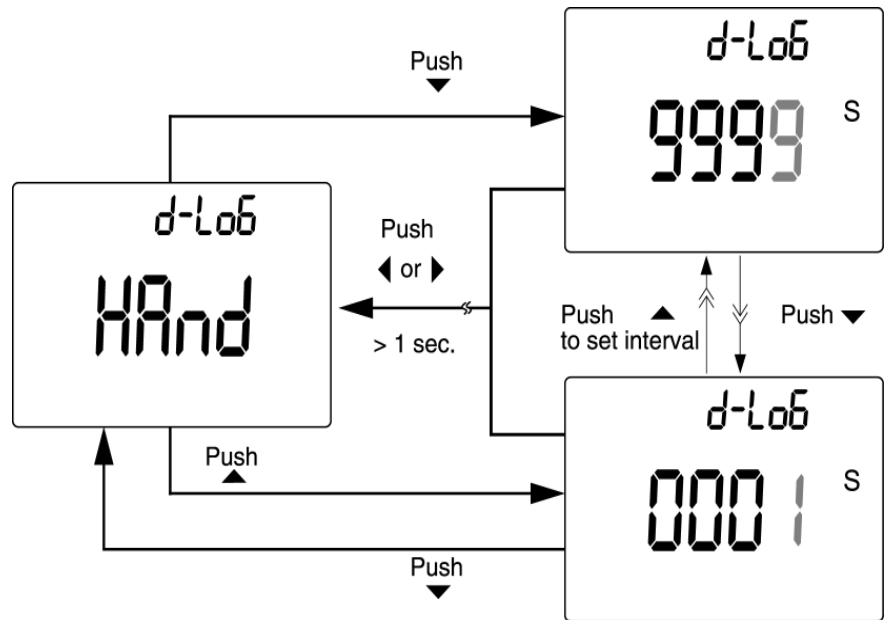

Figure 32 Data logging setup

Setting Thermocouple Types (for U1252A)

The types of thermocouple sensor that can be selected are J and K types. Default type is K type. Push ▲ or ▼ to switch between J and K type.

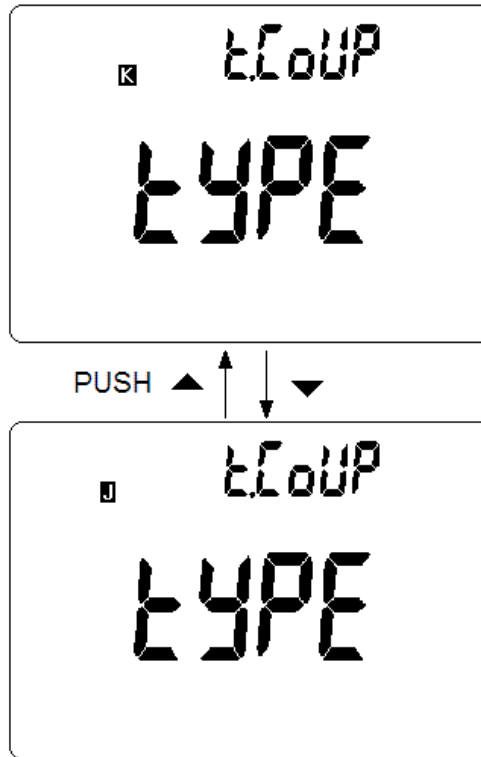

Figure 33 Thermocouple type setup

Setting Reference Impedance for dBm Measurement

The reference impedance can be set from 1 to 9999 Ω . The default value is 50 Ω .

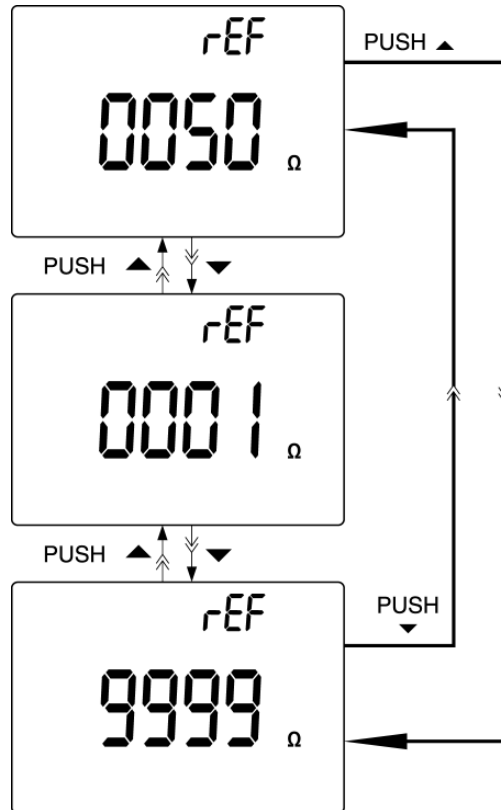

Figure 34 Reference impedance for dBm measurement setup

Setting Minimum Frequency Measurement

The minimum frequency setup influences the measuring rates for frequency, duty cycle, and pulse width. Typical measuring rate defined at the general specification is based on the minimum frequency of 1 Hz.

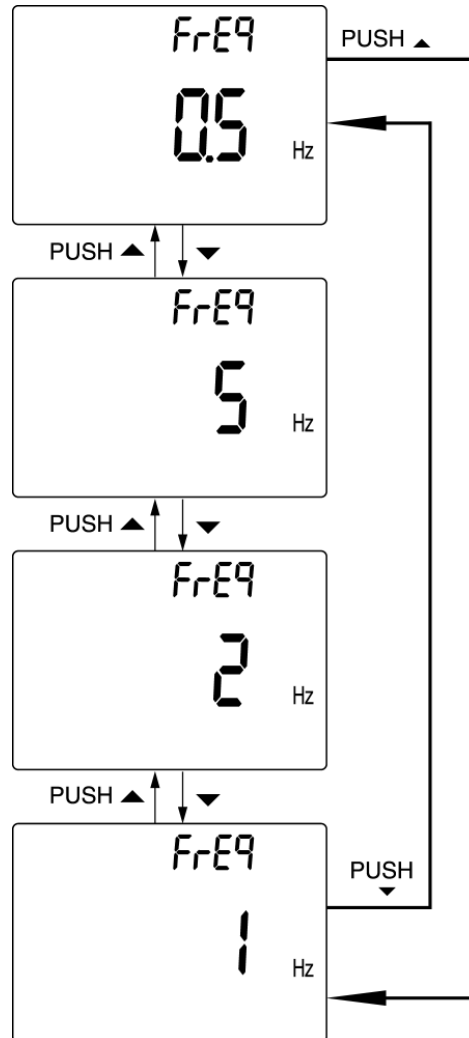



Figure 35 Minimum frequency setup

Setting Temperature Unit

Four combination displays are available:

- Celsius only (°C on primary display) single display setting
- Celsius-Fahrenheit (d-CF) and Fahrenheit-Celsius (d-FC) dual display setting.

NOTE

Primary-Secondary Display can be swapped by pushing 

- Fahrenheit only (°F on primary display) single display setting.

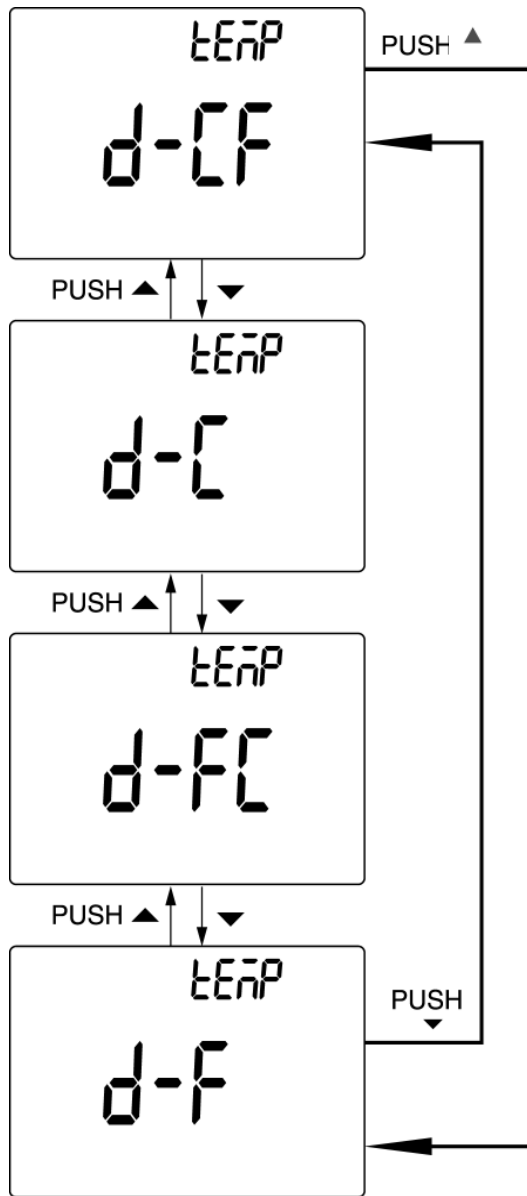

Figure 36 Temperature unit setup

Setting Auto Power Saving Mode

- The timer for APF (Auto Power OFF) can be set for the range of 1~99 minutes. To activate the meter after it has auto power off, turn the rotary switch to the OFF position, then turn it back on again.
- “OFF” means disables APF. **Auto OFF** is indicated on the display during subsequent measurements.

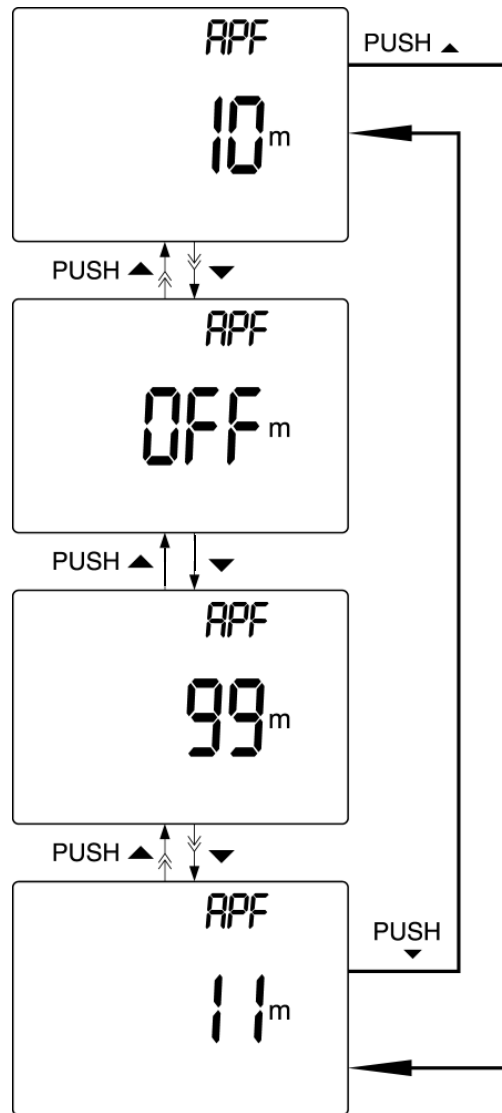

Figure 37 Auto power saving setup

Setting % Scale Readout

This setting converts the DC current measuring display to % scale readout – 4-20 mA or 0-20 mA as proportional to 0~100%. The 25% scale readout represents DC 8 mA at 4-20 mA and DC 5 mA at 0-20 mA.

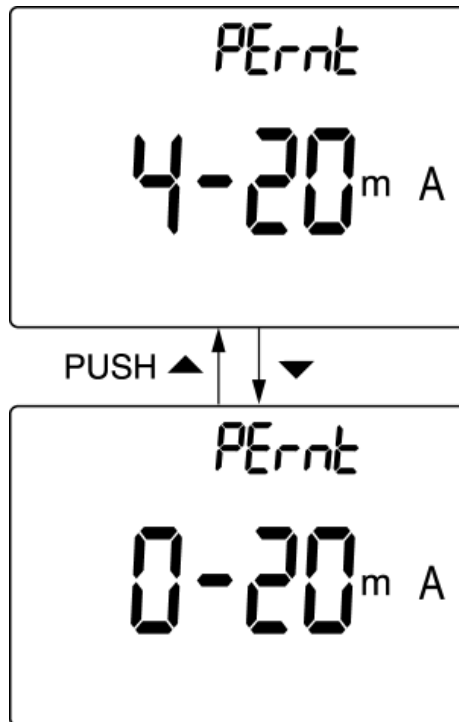

Figure 38 % scale readout setup

Setting Beep Frequency

- The driving frequency can be set to 2400, 1200, 600 or 300 Hz. "OFF" disables beep.

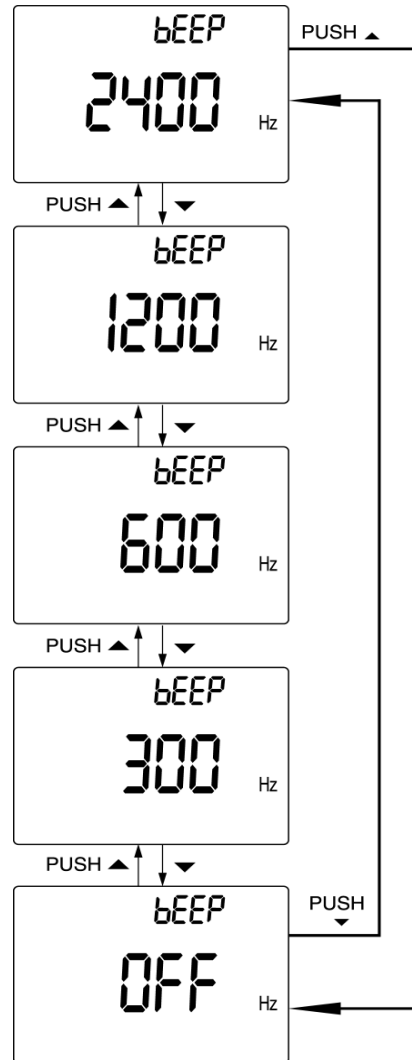

Figure 39 Beep frequency setup

Setting Backlit Timer

- Timer can be set to 1~99 seconds. Backlit turns off automatically after the set period.
- “OFF” disables turning off backlit automatically.

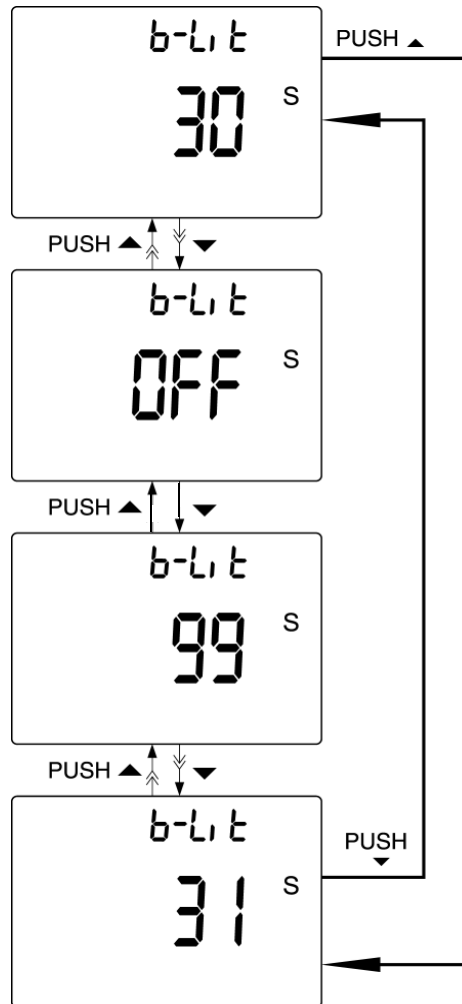

Figure 40 Backlit timer setup

Setting Baud Rate

The baud rate is selected for remote control. The available settings are 2400, 4800, 9600 and 19200 Hz.

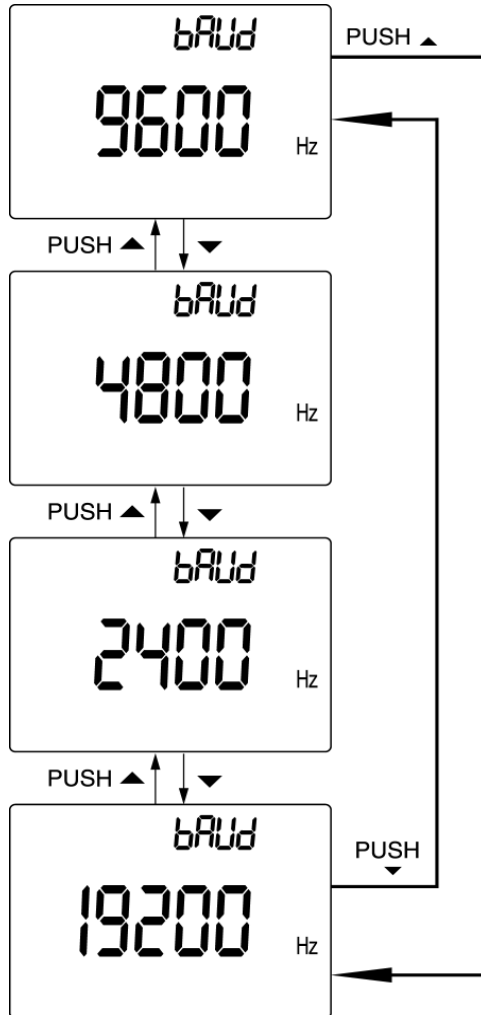

Figure 41 Baud rate setup remote control

Setting Parity Check

The parity check is selected for remote control. It can be set to either none, even or odd bit.

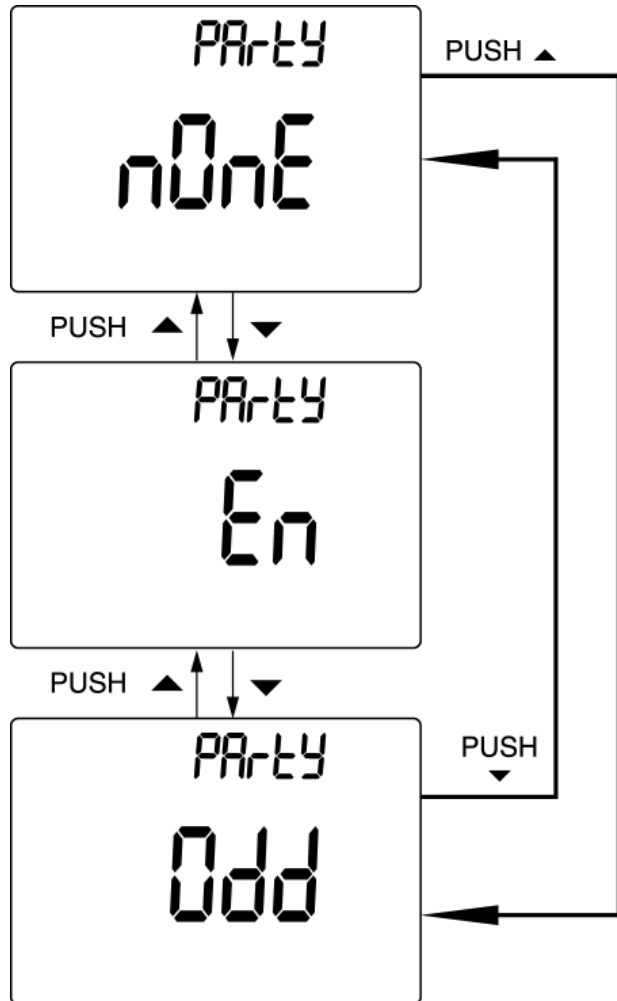

Figure 42 Parity check setup

Setting Data Bit

Data bit is selected for remote control. It can be set to either 8 or 7 bits.

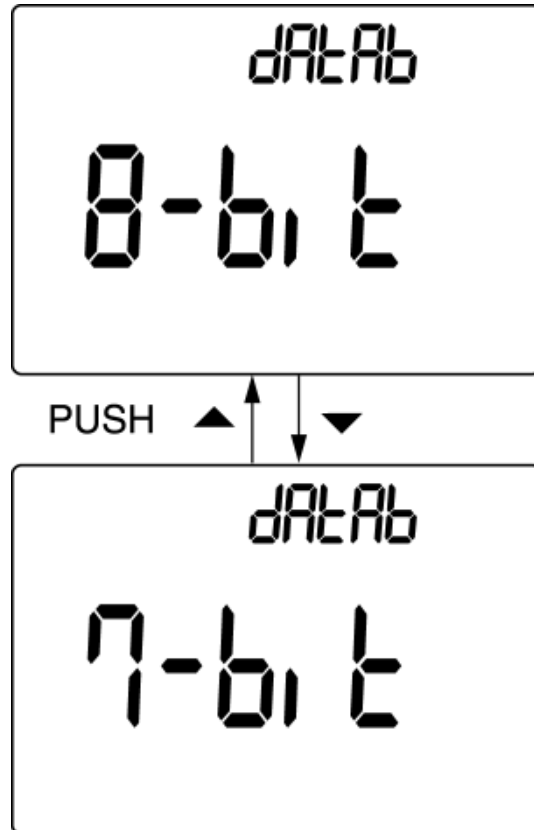

Figure 43 Data bit setup for remote control

Setting Echo Mode

- Echo ON enables return of characters to PC in remote communication.
- Echo OFF disables Echo mode.

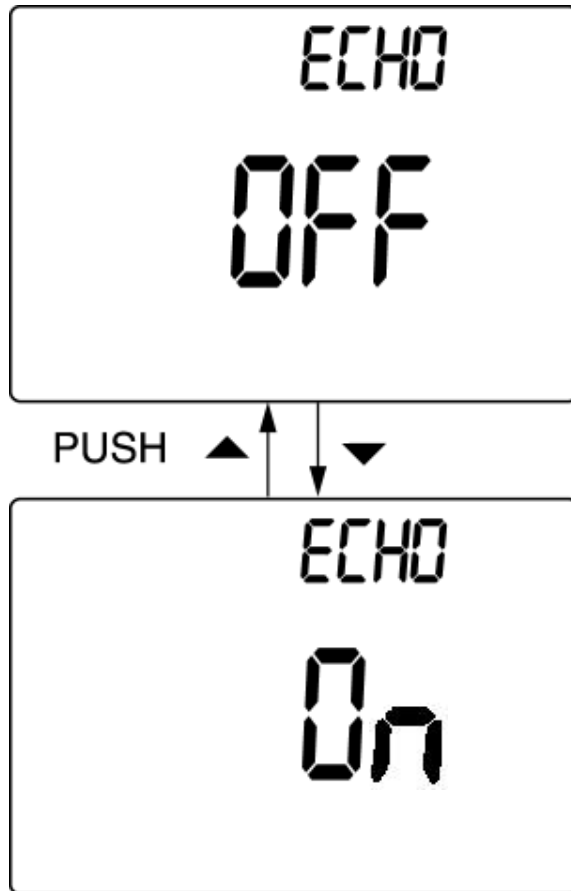

Figure 44 Echo mode setup for remote control

Setting Print Mode

Print ON enables print out of measured data to PC when measuring cycle is completed. In this mode, the meter automatically sends the newest data to the host continuously but does not accept any commands from the host.

Remote flashes during Print operation.

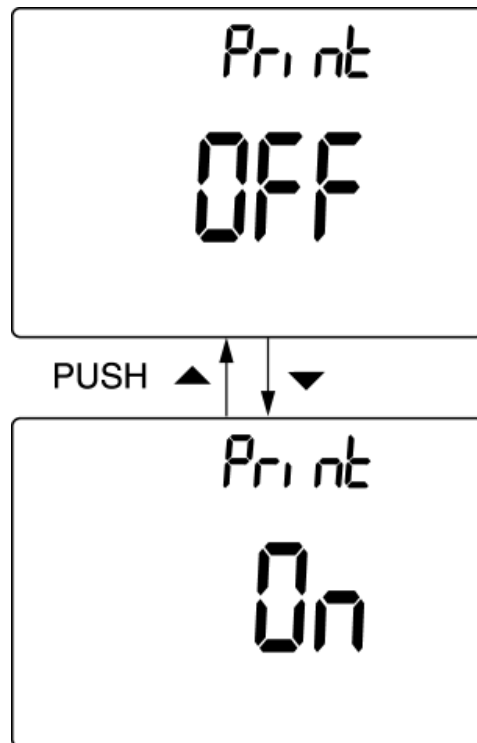



Figure 45 Print mode setup for remote control

Returning to Default Factory Settings

- Push  for more than 1 second to reset to default factory settings except the Temperature setting.
- The Reset menu item automatically reverts to Refresh Hold menu item after reset has taken place.

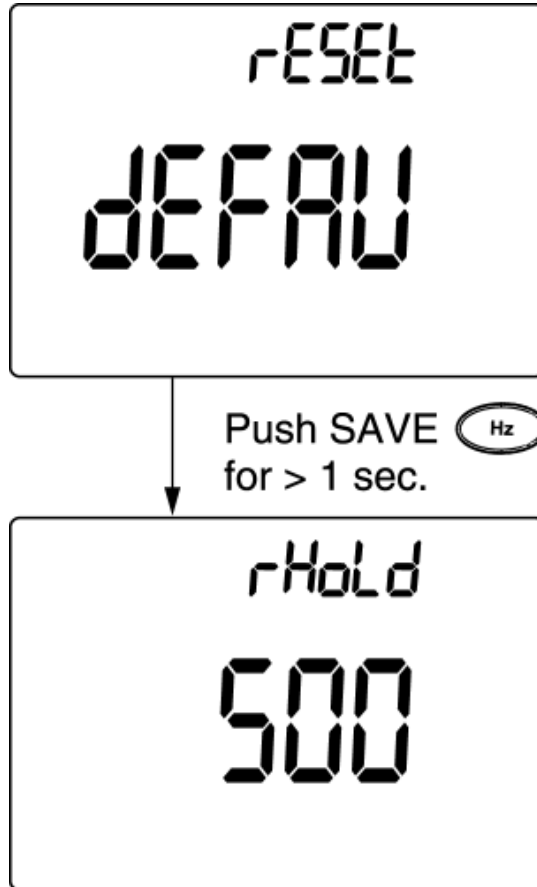
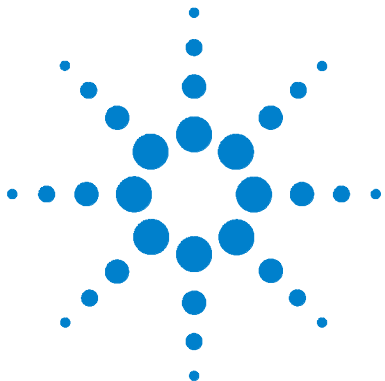

Figure 46 Reset setup



5 Maintenance

Introduction	104
General Maintenance	104
Battery Replacement	105
Charging Battery	106
Fuse Replacement	113
Troubleshooting	115

This chapter will help you troubleshoot a failing handheld digital multimeter.



Introduction

Repair or service which are not covered in this manual should only be performed by qualified personnel.

General Maintenance

WARNING

Ensure that terminal connections are correct for that particular measurement before any measurement. To avoid damaging the device, do not exceed the input limit.

Besides the above hazard, dirt or moisture in the terminals can distort readings. Cleaning steps are as follows:

- 1 Turn the meter off and remove the test leads.
- 2 Turn the meter over and shake out any dirt that may have accumulated in the terminals.
- 3 Wipe the case with a damp cloth and mild detergent – do not use abrasives or solvents. Wipe the contacts in each terminal with a clean swab dipped in alcohol.

Battery Replacement

WARNING

Never discharge the battery by shorting it or reverse polarity in any subjects. Make sure the battery is rechargeable before charging it. Never rotate the rotary switch under charging as DC 24V has been applied to charging terminals.

The meter is powered by 7.2 V battery, and use only specified battery. To ensure the specification specified, it is suggested to replace battery immediately when the sign of low battery is displayed and flashing. If your meter has specified rechargeable battery inside, please go to “Charging The Battery”. Below is the procedures for battery replacement:

- 1 At the rear panel, turn the screw on the battery cover from LOCK to OPEN position (counterclockwise).

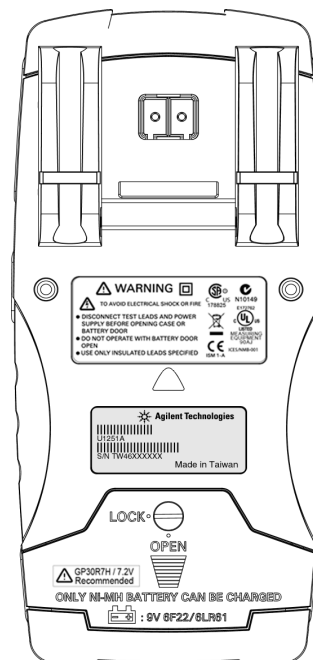

- 2 Slide down and the battery cover.
- 3 Lift the battery cover up.
- 4 Replace the specified battery.
- 5 Reverse the procedure of opening the cover to close the bottom cover.

Charging Battery



WARNING

Never discharge the battery by shorting it or reverse polarity in any subjects. Make sure the battery is rechargeable before charging it. Never rotate the rotary switch under charging as DC 24V has been applied to charging terminals.

NOTE

For the battery charger, the mains supply voltage fluctuations are not to exceed +/- 10%.

This meter is powered by 7.2V NiMH rechargeable battery. It is suggested to use specified accessory of 24V DC adaptor to charge the rechargeable battery. Please keep in mind never rotate the rotary switch as the DC 24V has been applied to the charging terminals. Follow the following procedures to charge the battery:

- 1 Remove and disconnect the test leads from meter.
- 2 Turn the rotary switch to the position of  . Plug power cord to DC adapter.
- 3 Plug the Red (+)/ Black (-) banana terminals of DC adapter to  CHG and "COM" terminals, respectively. The DC adaptor can be replaced with a DC power supply, in order to set a DC24V output and the over current limitation to <0.5A. Ensure the polarity of the connection is correct.

- 4 The primary display will indicate “bAt” and the ‘SBY’ is flashing on the second display and short tone sounds to remind you whether to charge battery or not. Press **SHIFT** button to start charging the battery, or the meter will automatically start the self-test after 24V supply is applied. It is recommended not to charge the battery if the battery capacity is over 90%.

Condition	Battery Voltage	Proportional Percentage
Trickle (SBY)	6.0 V ~ 8.2 V	0% ~ 100%
Under charging	7.2 V ~ 10.0 V	0% ~ 100%

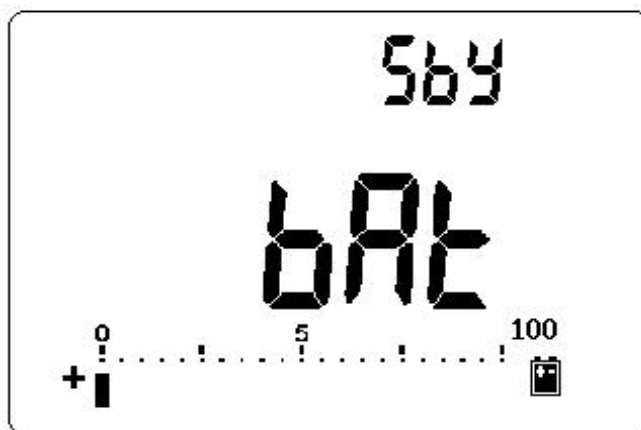

Figure 47 Battery capacity display as trickle

- 5 After pushing the SHIFT button or self-start, the meter will do a self-test to check if the battery inside the meter is a rechargeable battery or not. The self-test will take about 2-3 minutes. Avoid from operating any push buttons during the self-test. An error message is displayed shown below.

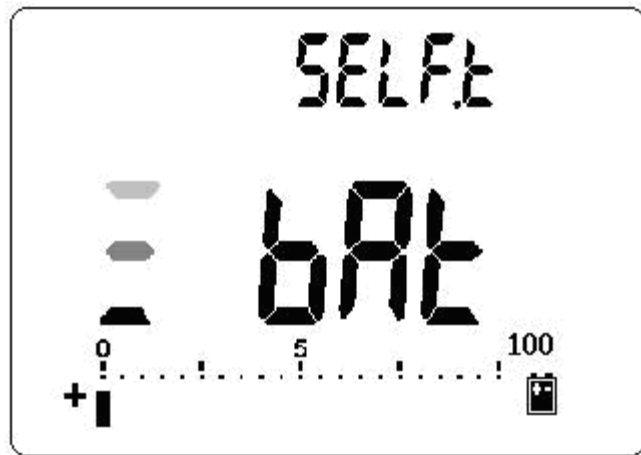

Figure 48 Self test

Error Condition	Secondary Display
<p>OL</p> <ul style="list-style-type: none"> • No battery in the meter • Battery failing • Battery is full 	 <p>The secondary display shows the error code 'OL' at the top. Below it, the word 'BAT' is displayed in large characters. At the bottom, there is a battery level indicator consisting of a horizontal bar with 10 segments, all of which are filled. The bar is labeled with '0' at the left end, '5' at the midpoint, and '100' at the right end. A small battery icon is shown to the right of the bar.</p>
<p>C-Err</p> <ul style="list-style-type: none"> • No rechargeable battery inside • Battery failing 	 <p>The secondary display shows the error code 'C-Err' at the top. Below it, the word 'BAT' is displayed in large characters. At the bottom, there is a battery level indicator consisting of a horizontal bar with 10 segments, only the first 4 of which are filled. The bar is labeled with '0' at the left end, '5' at the midpoint, and '100' at the right end. A small battery icon is shown to the right of the bar.</p>

Figure 49 Error messages

NOTE

- If **OL** message occurs while the battery is inside, please do not charge the battery.
- If **C-Err** message occurs, check if the battery is the specified type. We specified the correct battery in this guide. Please make sure that the battery is the specified rechargeable battery before charging it again. After replacing with the specified rechargeable battery, press **SHIFT** button to redo the self-test. Replace with a new battery if the C-Err condition is displayed.

The smart charging mode will be started if passed self-test. The charging time is limited to within 220 minutes. That means the battery will not be charged over 220 minutes. The secondary display will count down the charging time. During the charging in progress, no pushbuttons can be operated. The error message maybe indicated during charging to prevent overcharging on the battery.

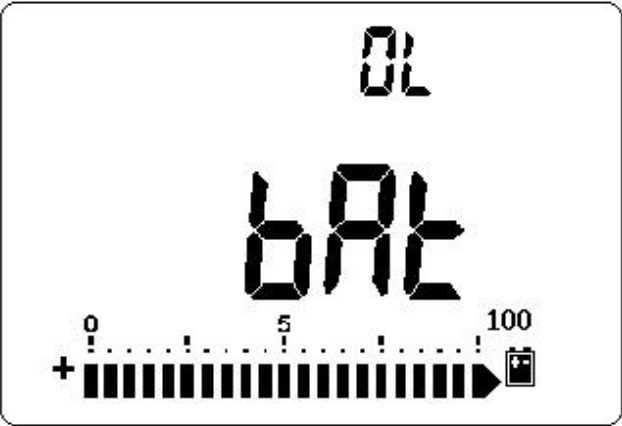
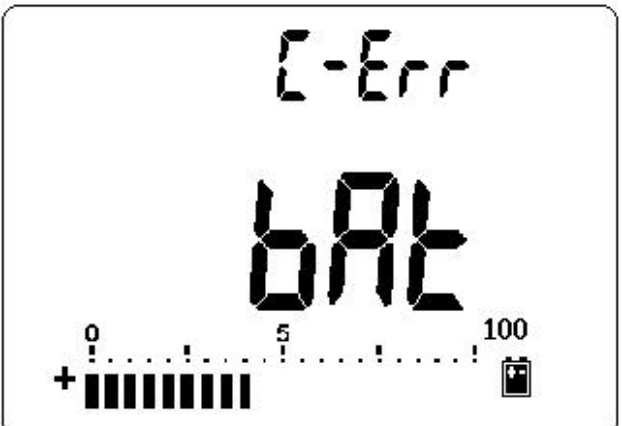
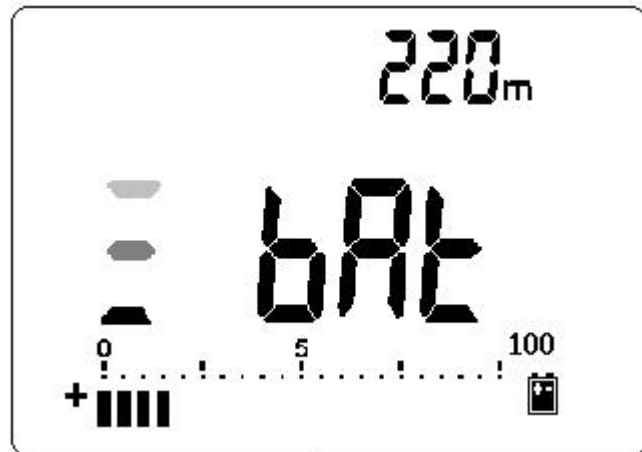



Figure 50 Charging mode

7. The charge end message (C-End) will be displayed on the secondary display once charging is completed. The trickle charging current will be provided to maintain the battery capacity. The flashing signs of  and  will be displayed to show the trickle state.
8. Remove the DC adapter when the C-End is displayed on the secondary display. Do not turn the rotary switch before removing the adapter from the terminals.

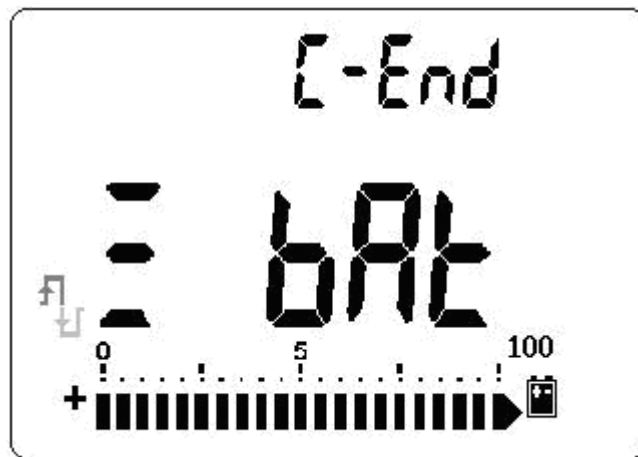

Figure 51 Charge end and trickle state

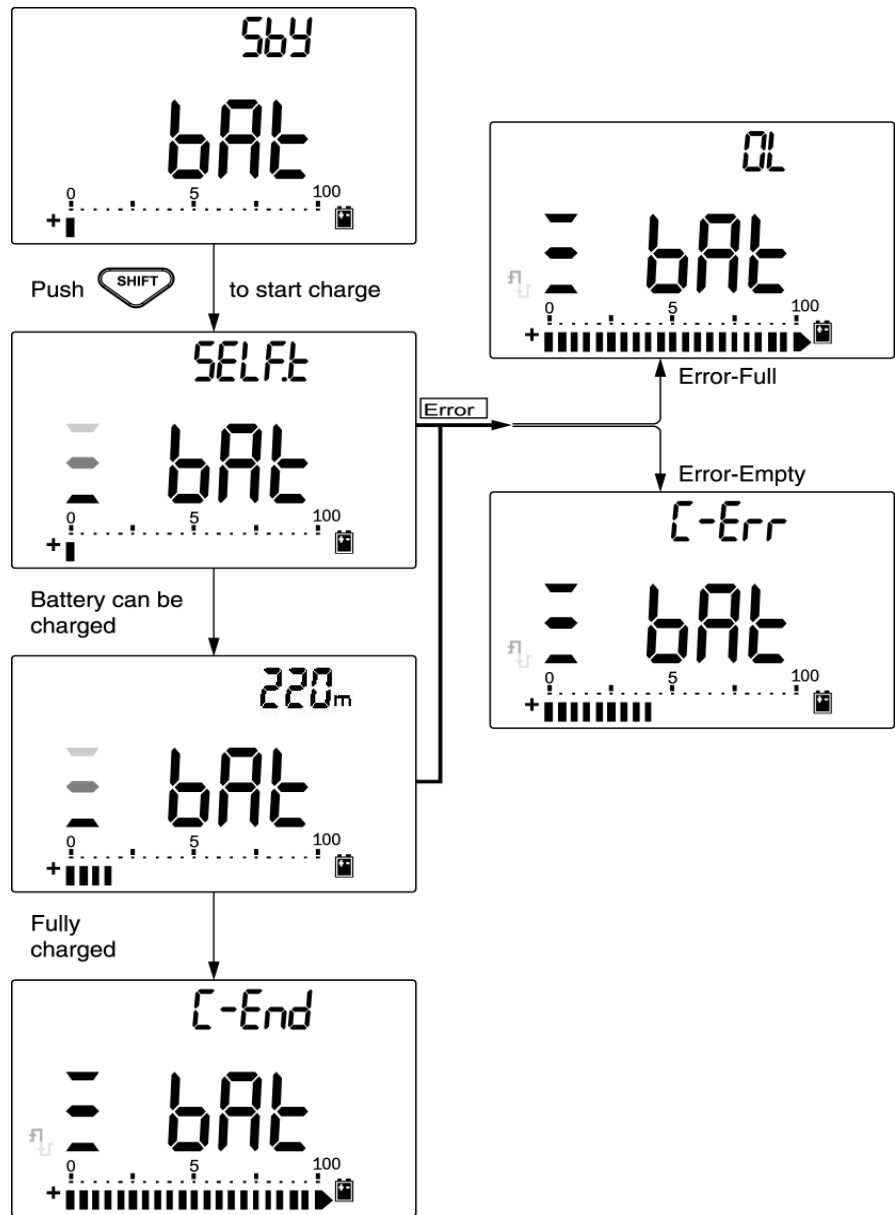

Figure 52 Battery charging procedures

Fuse Replacement

NOTE

This manual provides only the fuse replacement procedures, but not the fuse replacement markings.

The following procedures will assist you to replace the fuse of the meter.

- 1** Turn the meter off and disconnect the test leads from external equipment. Make sure the adaptor is removed.
- 2** Use clean/dry gloves on your hands and do not touch any components except the fuse and plastic parts. The current calibration is considered shunt only, so it's not recommended to recalibrate the meter after replacing the fuse.
- 3** Remove the battery cover compartment to replace the fuse.
- 4** Loosen 2 screws on bottom case and remove the cover.
- 5** Loosen two screws on top corners to lift the circuit board.
- 6** Gently remove the defective fuse by prying one end of the fuse loose and removing it out of the fuse bracket.
- 7** Replace a new fuse of the same size and rating. Make sure the new fuse is centered in the fuse holder.
- 8** Ensure that the rotary switch on the top case and circuit board switch stay on the OFF position.
- 9** Then re-fasten the circuit board and the bottom cover respectively.
- 10** Refer to the table below for the part number, rate and size of the fuses.

Fuse	Agilent Part Number	Rating	Size	Type
1	2110-1400	440mA/1000V	10 mm x 35 mm	Fast blow Fuse
2	2110-1402	11A/1000V	10 mm x 38 mm	

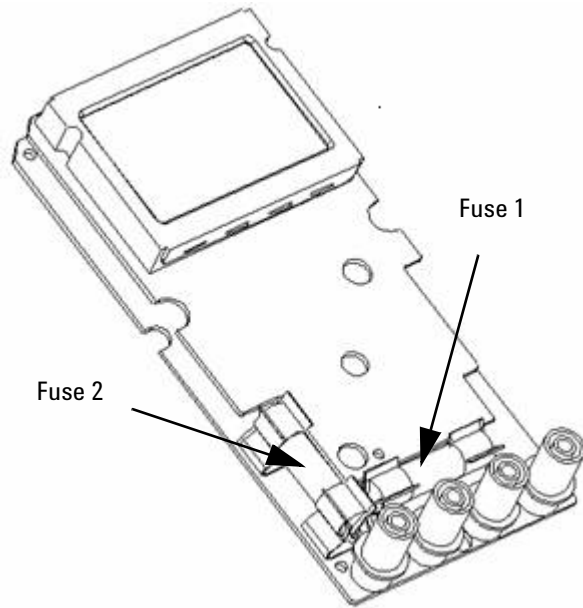

Figure 53 Fuse replacement

Troubleshooting

WARNING

To avoid electrical shock, do not perform any service unless you are qualified to do so.

If the instrument fails to operate, check the battery and test leads. Replace them if necessary. And if the instrument still doesn't function, check the operating procedure in this instruction manual. When servicing, Use specified replacement parts only. The table below will assist you to identify some basic problems.

Malfunction	Identification
No LCD display after power ON	<ul style="list-style-type: none"> • Check battery. Charge or replace battery.
No beeper tone	<ul style="list-style-type: none"> • Check setup mode and verify if the beeper is set to OFF. Then select the desired driving frequency.
Failed on current measurement	<ul style="list-style-type: none"> • Check the fuse.
No charging indication	<ul style="list-style-type: none"> • Check external adaptor whether the output is DC 24V and plug into the charging terminals completely. • Line power voltage (100V~240V AC 50Hz/ 60Hz)
Failed on Remote control	<ul style="list-style-type: none"> • The optical side of cable connected to meter, the text side of cover should be up. • Check the baud rate, parity, Data bit, Stop bit (default is 9600, n, 8, 1) • Driver install for USB- RS232.

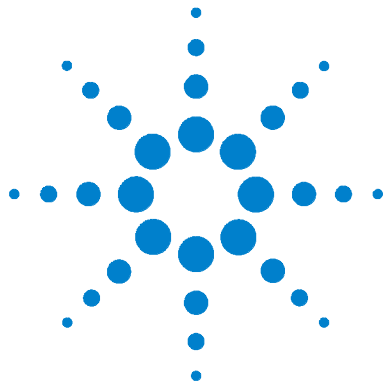

6 Accessories

Checking the Shipping Contents 118

List of Accessories 119

This chapter contains information on the standard and optional accessories. It includes the shipping contents along with this instrument.



Checking the Shipping Contents

Verify that you have received the following items with your multimeter:

- Soft carrying case
- 9 V alkaline battery
- Rechargeable 7.2 V battery (for U1252A only)
- Power cord & AC adapter (for U1252A only)
- Standard Test Lead Kit
- Quick Start Guide
- CD containing the User's Guide, application software and instrument drivers
- Certificate of Calibration

If anything is missing, contact your nearest Agilent Sales Office.

List of Accessories

Type	Model ID	Description	U1251A	U1252A
		Soft Carrying Case	x	x
		Rechargeable 7.2 V Battery		x
Standard	U1160A	Test Probe Leads	x	x
		Alligator Clips	x	x
		SMT Grabber	x	x
		Fine Tips Test Probes	x	x
		Mini Grabber (black only)	x	x
Optional	U1180A	T/C Adapter, non-compensation transfer adapter	x	x
		T/C bead, K type	x	x
		T/C bead, J type		x
	U1161A	Medium Jaw Alligator Clips	x	x
		Extension Lead set	x	x
		Extension Test Probe	x	x
		Banana Plug	x	x
	U1173A	IR-USB Cable	x	x



7 Performance Tests and Calibration

Calibration Overview	122
Recommended Test Equipment	124
Basic Operating Test	125
Test Considerations	128
Performance Verification Tests	130
Calibration Security	138
Calibration Process	142
Adjustments Consideration	144

This chapter contains performance test procedures and adjustment procedures. The performance tests procedures allow you to verify that the handheld digital multimeter is operating within its published specifications.



Calibration Overview

This manual contains procedures for verification of the instrument's performance and adjustment (calibration).

NOTE

Make sure you have read “[Test Considerations](#)” on page 128 before calibrating the instrument.

Closed - case Electronic Calibration

The instruments features closed-case electronic calibration. No internal mechanical adjustments are required. The instrument calculates correction factors based upon the input reference value you set. The new correction factors are stored in non-volatile memory until the next calibration adjustment is performed. Non - volatile EEPROM calibration memory does not change when power has been off.

Agilent Technologies Calibration Services

When your instrument is due for calibration, contact your local Agilent Service Center for a low-cost recalibration. This product is supported on automated calibration systems, which allow Agilent to provide this service at competitive prices.

Calibration Interval

A 1-year interval is adequate for most applications. Accuracy specifications are warranted only if adjustment is made at regular calibration intervals. Accuracy specifications are not

warranted beyond the 1-year calibration interval. Agilent does not recommend extending calibration intervals beyond 2 years for any application.

Adjustment is Recommended

Specifications are only guaranteed within the period stated from the last adjustment. Whatever calibration interval you select, Agilent recommends that complete re-adjustment should always be performed at the calibration interval. This will assure that the U1251A/U1252A will remain within specification for the next calibration interval. This criteria for re-adjustment provides the best long-term stability.

Performance data is measured during Performance Verification Tests and this does not guarantee the instrument will remain within these limits unless the adjustments are performed.

Refer to the [“To Read the Calibration Count”](#) on page 153 and verify that all adjustments have been performed.

Recommended Test Equipment

The test equipment recommended for the performance verification and adjustment procedures is listed below. If the exact instrument is not available, substitute calibration standards of equivalent accuracy.

A suggested alternative method would be to use the Agilent 3458A 8½ -Digit Digital Multimeter to measure less accurate yet stable sources. The output value measured from the source can be entered into the instrument as the target calibration value.

Table 4 Recommended Test Equipment

Application	Recommended Equipment	Recommended Accuracy Requirements
DC Voltage	Fluke 5520A	<1/5 instrument 1 year spec
DC Current	Fluke 5520A	<1/5 instrument 1 year spec
Resistance	Fluke 5520A	<1/5 instrument 1 year spec
AC Voltage	Fluke 5520A	<1/5 instrument 1 year spec
AC Current	Fluke 5520A	<1/5 instrument 1 year spec
Frequency	Agilent 33250A	<1/5 instrument 1 year spec
Capacitance	Fluke 5520A	<1/5 instrument 1 year spec
Duty Cycle	Fluke 5520A	<1/5 instrument 1 year spec
Nanosiemens	Fluke 5520A	<1/5 instrument 1 year spec
Diode	Fluke 5520A	<1/5 instrument 1 year spec
Frequency Counter	Agilent 33250A	<1/5 instrument 1 year spec
Temperature	Fluke 5520A	<1/5 instrument 1 year spec
Square Wave	Agilent 53131A and Agilent 34401A	<1/5 instrument 1 year spec
Short	Shorting Plug - Dual banana plug with copper wire short between 2 terminal	<1/5 instrument 1 year spec

Basic Operating Test

Basic Operating Test is to test the basic operability of the instrument. Repair is required if the instrument fails the Basic Operating Test.

Backlit Test

Press the BAT button to test the backlight. It will momentarily toggle backlit ON and OFF.

Testing the Display

Press the **Hold** button and turn on the Meter to view all segments of the display. Compare the display with the example in Figure 1.

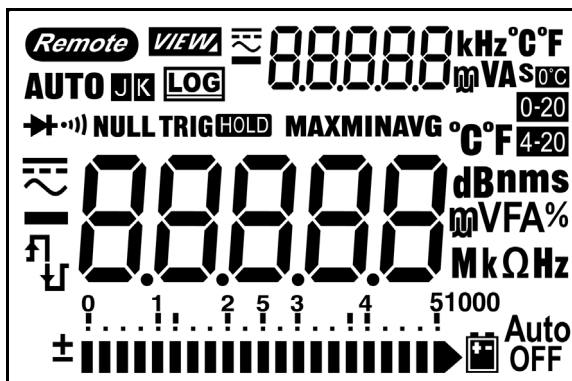

Figure 54 LCD display

Current Terminal Test

This test determines if the input warning of the current terminal test is functioning properly.

The meter sounds an alert beep when the test lead is inserted to A terminal but rotary switch is not set to mA.A function. The primary display will indicate “A-Err”. It is shown in Figure 55. The primary display will keep flashing unless the test lead is removed from “A” terminal.

NOTE

Before conducting this test, make sure the beep function is not disabled in setup.

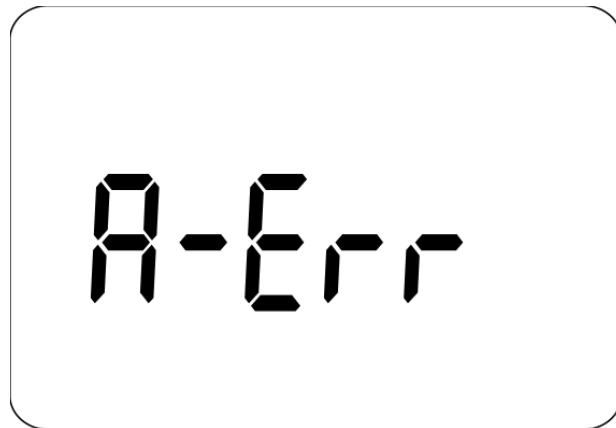

Figure 55 Input warning

Charge Terminal Alert Test

This test determines if the charge terminal alert is operating properly.



The meter sounds an alert when the CHG terminal detects a voltage level of more than 5V but rotary switch is not set to ^{OFF}CHG position. The meter sounds an alert beep and primary display indicates and flashes “Ch.Err” until the lead is removed from CHG terminal.



Figure 56 Charge terminal alert

NOTE

Before conducting this test, make sure the beep function is not disabled in setup.

Test Considerations

Long test leads can also act as an antenna causing pick-up of AC signals.

For optimum performance, all procedures should comply with the following recommendations:

- Assure that the calibration ambient temperature is stable and between 18 °C and 28 °C. Ideally the calibration should be performed at 23 °C ± 1 °C.
- Assure ambient relative humidity is less than 80%.
- Allow a 5 minutes warm-up period with a Shorting Plug connected to the V and COM input terminals.
- Use shielded twisted pair Teflon-insulated cables to reduce settling and noise errors. Keep the input cables as short as possible.
- Connect the input cable shields to earth ground. Except where noted in the procedures, connect the calibrator LO source to earth ground at the calibrator. It is important that the LO to earth ground connection be made at only one place in the circuit to avoid ground loops.

Because the instrument is capable of making very accurate measurements, you must take special care to ensure that the calibration standards and test procedures used do not introduce additional errors. Ideally, the standards used to verify and adjust the instrument should be an order of magnitude more accurate than each instrument range full-scale error specification.

For the DC voltage, DC current, and resistance gain verification measurements, you should ensure the calibrator's "0" output is correct. You will need to set the offset for each range of the measuring function being verified.

Input Connections

Test connections to the instrument are best accomplished using the dual banana plug with copper wire short between two terminals for low-thermal offset measurement. Shielded, twisted-pair, Teflon interconnect cables of minimum length are recommended between the calibrator and the multimeter. Cable shields should be earth ground referenced. This configuration is recommended for optimal noises and settling time performance during calibration.

Performance Verification Tests

Use the Performance Verification Tests to verify the measurement performance of the instrument. The performance verification tests use the instrument's specifications listed in the U1251A/U1252A Data Sheet.

The performance verification tests are recommended as acceptance tests when you first receive the instrument. The acceptance test results should be compared against the 1 year test limits. After acceptance, you should repeat the performance verification tests at every calibration interval.



If the instrument fails performance verification, adjustment or repair is required. Adjustment is recommended at every calibration interval. If adjustment is not made, you must establish a 'guard band', using not more than 80% of the specifications, as the verification limits.

NOTE





Make sure you have read ["Test Considerations"](#) on page 128 before doing the performance verification tests.



Perform the verification test steps in the following Table 5:

Table 5 Verification Test







Step	Test Function	Range	5520A Output	Error from nominal 1 year	
				U1251A	U1252A
1	Turn the rotary switch to the  V position ^[1]	5 V	5 V, 1 kHz	± 32.5 mV	± 22.5 mV
			5 V, 10 kHz	± 52.5 mV	± 22.5 mV
			5 V, 20 kHz	N/A	± 41.5 mV
			5 V, 30 kHz	± 84 mV	N/A
			5 V, 100 kHz	N/A	± 187mV
		50 V	50 V, 1 kHz	± 325 mV	± 225 mV
			50 V, 10 kHz	± 525 mV	± 225 mV
			50 V, 20 kHz	N/A	± 415 mV
			50 V, 30 kHz	± 840 mV	N/A
			50 V, 100 kHz	N/A	± 1.87 V
		500 V	500 V, 1 kHz	± 3.25 V	± 2.25 V
			500 V, 10 kHz	± 5.25 V	± 2.25V
		1000 V	1000 V, 1 kHz	± 10 V	± 8.0 V
		2	Press  button to go to frequency mode	9.9999kHz	0.48 V, 1 kHz
3	Press  button to go to Duty Cycle mode	0.01% – 99.99%	5.0 Vpp @ 50%, Square Wave, 50 Hz	± 0.315%	± 0.315%







7 Performance Tests and Calibration

Step	Test Function	Range	5520A Output	Error from nominal 1 year	
				U1251A	U1252A
4	Turn the rotary switch to  V position (for model U1252A), to  V position (for model U1251A)	5 V	5 V	± 2 mV	±1.75 mV
		50 V	50 V	± 20 mV	± 17.5 mV
		500 V	500 V	± 200 mV	± 200 mV
		1000 V	1000 V	± 800 mV	± 800 mV
5	Press  button to go to the  V mode ^[1]	5 V	5 V, 1 kHz	N/A	± 22.5 mV
			5 V, 10 kHz	N/A	± 22.5 mV
			5 V, 20 kHz	N/A	± 41.5 mV
			5 V, 100 kHz	N/A	± 187 mV
		50 V	50 V, 1 kHz	N/A	± 225 mV
			50 V, 10 kHz	N/A	± 225 mV
			50 V, 20 kHz	N/A	± 415 mV
			50 V, 100 kHz	N/A	± 1.87 V
		500 V	500 V, 1 kHz	N/A	± 2.25 V
			500 V, 10 kHz	N/A	± 2.25 V
		1000 V	1000 V, 1 kHz	N/A	± 8.0 V





Step	Test Function	Range	5520A Output	Error from nominal 1 year	
				U1251A	U1252A
6	Turn the rotary switch to the  mV position	50 mV	50 mV	$\pm 75 \mu\text{V}^{[2]}$	$\pm 75 \mu\text{V}^{[2]}$
		500 mV	500 mV	$\pm 0.2 \text{ mV}$	$\pm 0.175 \text{ mV}$
			-500 mV	$\pm 0.2 \text{ mV}$	$\pm 0.175 \text{ mV}$
		1000 mV	1000 mV	$\pm 0.8 \text{ mV}$	$\pm 0.75 \text{ mV}$
			-1000 mV	$\pm 0.8 \text{ mV}$	$\pm 0.75 \text{ mV}$
		7	Press  button to go to the  mV mode ^[1]	50 mV	50 mV, 1 kHz
50 mV, 10 kHz	$\pm 0.54 \text{ mV}$				$\pm 0.39 \text{ mV}$
50 mV, 20 kHz	N/A				$\pm 0.415 \text{ mV}$
50 mV, 30 kHz	$\pm 0.86 \text{ mV}$				N/A
50 mV, 100 kHz	N/A				$\pm 1.87 \text{ mV}$
500 mV	500 mV, 45 Hz				$\pm 5.6 \text{ mV}$
	500 mV, 1 kHz			$\pm 3.25 \text{ mV}$	$\pm 2.25 \text{ mV}$
	500 mV, 10 kHz			$\pm 5.4 \text{ mV}$	$\pm 2.25 \text{ mV}$
	500 mV, 20 kHz			N/A	$\pm 4.15 \text{ mV}$
	500 mV, 30 kHz			$\pm 8.6 \text{ mV}$	N/A
	500 mV, 100 kHz			N/A	$\pm 18.7 \text{ mV}$
1000 mV	1000 mV, 1 kHz			$\pm 8.5 \text{ mV}$	$\pm 6.5 \text{ mV}$
	1000 mV, 10 kHz			$\pm 12.5 \text{ mV}$	$\pm 6.5 \text{ mV}$
	1000 mV, 20 kHz			N/A	$\pm 11.5 \text{ mV}$
	1000 mV, 30 kHz			$\pm 20.0 \text{ mV}$	N/A
	1000 mV, 100 kHz			N/A	$\pm 47.0 \text{ mV}$

7 Performance Tests and Calibration

Step	Test Function	Range	5520A Output	Error from nominal 1 year	
				U1251A	U1252A
8	Turn the rotary switch to the Ω position	500 Ω	500 Ω	$\pm 500 \text{ m}\Omega$ ^[3]	$\pm 350 \text{ m}\Omega$ ^[3]
		5 k Ω	5 k Ω	$\pm 4.5 \text{ }\Omega$ ^[3]	$\pm 3 \text{ }\Omega$ ^[3]
		50 k Ω	50 k Ω	$\pm 45 \text{ }\Omega$	$\pm 30 \text{ }\Omega$
		500 k Ω	500 k Ω	$\pm 450 \text{ }\Omega$	$\pm 300 \text{ }\Omega$
		5 M Ω	5 M Ω	$\pm 10.5 \text{ k}\Omega$	$\pm 8 \text{ k}\Omega$
		50 M Ω ^[4]	50 M Ω	$\pm 0.510 \text{ M}\Omega$	$\pm 0.505 \text{ M}\Omega$
		500 M Ω	500 M Ω	N/A	$\pm 40.1 \text{ M}\Omega$
9	Press  button to go to ns mode	500 nS ^[5]	50 nS	$\pm 0.7 \text{ nS}$	$\pm 0.6 \text{ nS}$
10	Turn the rotary switch to the Hz/  position (for model U1252A), to  position (for model U1251A)	Diode	1 V	$\pm 1 \text{ mV}$	$\pm 1 \text{ mV}$
			33250A Output		
11	Press  button to go to frequency counter mode ^[6]	999.99 kHz	200 mVrms, 100 kHz	N/A	$\pm 52 \text{ Hz}$
12	Press  button to go to frequency counter mode divide by 100	99.999 MHz	600 mVrms, 10 MHz	N/A	$\pm 5.2 \text{ kHz}$
			5520A Output		
13	Turn the rotary switch to the TEMP/  position ^[7]	10.000 nF	10.000 nF	$\pm 0.108 \text{ nF}$	$\pm 0.108 \text{ nF}$
		100.00 nF	100.00 nF	$\pm 1.05 \text{ nF}$	$\pm 1.05 \text{ nF}$
		1000.0 nF	1000.0 nF	$\pm 10.5 \text{ nF}$	$\pm 10.5 \text{ nF}$
		10.000 μF	10.000 μF	$\pm 0.105 \text{ }\mu\text{F}$	$\pm 0.105 \text{ }\mu\text{F}$

Step	Test Function	Range	5520A Output	Error from nominal 1 year	
				U1251A	U1252A
		100.00 μ F	100.00 μ F	$\pm 1.05 \mu$ F	$\pm 1.05 \mu$ F
		1000.0 μ F	1000.0 μ F	$\pm 10.5 \mu$ F	$\pm 10.5 \mu$ F
		10.00 mF	10.00 mF	± 0.105 mF	± 0.105 mF
		100.00 mF	10.00 mF	± 0.4 mF	± 0.4 mF
14	Press  button to go to TEMP mode ^[8]	-200 °C until 1372 °C	0 °C	± 3 °C	± 3 °C
			100 °C	± 3.3 °C	± 3.3 °C
15	Turn the rotary switch to the  μ A position	500 μ A	500 μ A	$\pm 0.55 \mu$ A ^[9]	$\pm 0.3 \mu$ A ^[9]
		5000 μ A	5000 μ A	$\pm 5.5 \mu$ A ^[9]	$\pm 3 \mu$ A ^[9]
16	Press  button to go to  μ A mode ^[1]	500 μ A	500 μ A, 1 kHz	$\pm 4.2 \mu$ A	$\pm 3.7 \mu$ A
			500 μ A, 20 kHz	$\pm 15.8 \mu$ A	$\pm 3.95 \mu$ A
		5000 μ A	5000 μ A, 1 kHz	$\pm 42 \mu$ A	$\pm 37.0 \mu$ A
			5000 μ A, 20 kHz	± 0.156 mA	$\pm 39.5 \mu$ A
17	Turn the rotary switch to the  mA.A position	50 mA	50 mA	± 0.105 mA ^[9]	$\pm 80 \mu$ A ^[9]
		440 mA	400 mA	± 0.93 mA ^[9]	± 0.71 mA ^[9]
18	Press  button to go to  mA mode ^[1]	50 mA	50 mA, 1 kHz	± 0.42 mA	± 0.37 mA
			50 mA, 20 kHz	± 1.56 mA	± 0.395 mA
		440 mA	400 mA, 45 Hz	± 6.4 mA	± 4.2 mA
			400 mA, 1 kHz	± 3.4 mA	± 3.0 mA
Caution: Connect calibrator to handheld multimeter's A and COM terminal before applying 5A and 10A					
		5 A	5 A	± 16 mA	± 16 mA
		10 A ^[10]	10 A	± 40 mA	± 35 mA

7 Performance Tests and Calibration

Step	Test Function	Range	5520A Output	Error from nominal 1 year	
				U1251A	U1252A
19	Press  button to go to  A mode	5 A	5 A, 1 kHz	± 42 mA	± 37 mA
		3A	3 A, 5 kHz	± 96 mA	± 96 mA
		10 A ^[11]	10 A, 1 kHz	± 100 mA	± 90 mA
		Square Wave Output	Use 53131A		
20	Turn the rotary switch to the  position OUT	120 Hz @ 50%		N/A	± 26 mHz
		4800 Hz @ 50%		N/A	± 260 mHz
	 Duty Cycle OUT	100 Hz @ 50%		N/A	± 0.398% ^[12]
		100 Hz @ 25%		N/A	± 0.398% ^[12]
		100 Hz @ 75%		N/A	± 0.398% ^[12]
			Use 34410A		
	 Amplitude OUT	4800 Hz @ 99.609%		N/A	± 0.2V

- [1] The additional error to be added as frequency > 20 kHz and signal input < 10% of range: 300 counts of LSD per kHz.
- [2] The accuracy could be 0.05% + 10, always use relative function to zero thermal effect (short test leads) before measuring the signal.
- [3] The accuracy of 500 Ω and 5k Ω is specified after NULL function.
- [4] For range of 50 M Ω , the RH is specified for < 60%.
- [5] The accuracy is specified for < 50nS and after NULL function as open test lead.
- [6] All frequency counters are susceptible to error when measuring low voltage, low-frequency signals. Shielding inputs from external noise pickup is critical for minimizing measurement errors.
- [7] Use NULL mode to zero residual
- [8] The accuracy does not include the tolerance of thermocouple probe.
The thermal sensor plugged into the meter should be placed in the operating environment for at least an hour.
Use Null function to reduce the thermal effect.
- [9] Always use relative function to zero thermal effect with open test lead before measuring the signal.
If you do not use Relation function, add 20 digits for accuracy purposes.
- [10] 10A continuous, and additional 0.5% to specified accuracy when measuring a signal greater than 10 A~20 A for 30 seconds maximum.
After measured current for > 10 A, to cool down the meter for twice the measuring time you applied before low current measurement.
- [11] The current can be measuring from 2.5A to 10A continuous, and the additional of 0.5% to specified accuracy as measure the signal greater than 10A~20A for 30 seconds maximum.
After measured current for > 10A, to cool down the meter for 2 times of measuring time you applied before low current measurement
- [12] For signal frequency greater than 1 kHz, additional 0.1% per kHz to be added to accuracy

Calibration Security

The calibration security code prevents accidental or unauthorized adjustments to the instrument. When you first receive your instrument, it is secured. Before you can adjust the instrument, you must unsecure it by entering the correct security code (see [“Unsecuring the Instrument for Calibration”](#) on page 139).

The security code is set to 1234 when the instrument is shipped from the factory. The security code is stored in non-volatile memory, and does not change when power is turned off .

NOTE

You can unsecure the instrument from the front panel. The security code can only be changed from the front panel and remote interface after the instrument has been unsecured.

The security code may contain up to 4 numeric characters.



NOTE

See [“To Unsecure the Instrument Without the Security Code”](#) on page 141 if you forget your security code.

Unsecuring the Instrument for Calibration

Before you can adjust the instrument, you must unsecure it by entering the correct security code. The security code is set to 1234 when the instrument is shipped from the factory. The security code is stored in non-volatile memory, and does not change when power has been off.

To Unsecure the Instrument from the Front Panel

- 1 Turn the rotary switch to $\sim V$.
- 2 Press  and  button simultaneously to enter the Calibration Security Code entry mode.
- 3 The primary display shows 5555 and the secondary display show SECUR.

- 4 Use the editing keys  and  to step each character in the code.



Use the  and  to select each character.

- 5 Press  (Save) when done.
- 6 If the correct security code is entered, the secondary display will show PASS.

To Change the Instrument Calibration Security Code from the Front Panel

- 1 When the instrument in the unsecured mode, press  button for more than 1 second to enter Calibration Security Code setting mode.
- 2 The factory default calibration security code 1234 will be displayed on primary display.

- 3 Use the editing keys  and  to step each character in the code.

- 4 Use the  and  to change each character in the code.

- 5 Press  (Save) button, to store new calibration security code.









- 6 If the new calibration security code has been successfully store, the secondary display will show PASS.

To Unsecure the Instrument Without the Security Code

To unsecure the instrument without the correct security code, follow the steps below.

NOTE

If you do not have a record of the security code, first try 1234 (the factory default code) through front panel or remote interface.

- 1 Record the last 4 digit serial numbers of the instrument.
2. Turn the rotary switch to $\sim V$.
3. Press  and  button simultaneously to enter the Calibration Security Code entry mode.
4. The primary display shows 5555 and the secondary display shows SECUR.
5. Press  button for more than 1 second to enter Set Default Security Code mode. The secondary display shows SEr.no and primary display shows 5555.
6. Use the editing keys  and  to step each character in the code.
Use the  and  to select each character.
7. Set the code, same as last 4 digit serial number of the instrument.
8. Press  (Save) button, to confirm the entry.
9. If the correct 4 digit serial number was entered, the secondary display briefly show PASS.

Now you can use 1234 as the security code. If want to enter a new security code, see [“To Change the Instrument Calibration Security Code from the Front Panel”](#) on page 140. Make sure you record the new security code.

Calibration Process

The following general procedure is the recommended method to complete a full instrument calibration.

- 1 Read [“Test Considerations”](#) on page 128.
- 2 Perform the verification tests to characterize the instrument (incoming data).
- 3 Unsecure the instrument for calibration (see [“Calibration Security”](#) on page 138).
- 4 Perform the adjustment procedures (see [“Adjustments Consideration”](#) on page 144).
- 5 Secure the instrument against calibration.
- 6 Note the new security code and calibration count in the instrument's maintenance records.

NOTE

Make sure to quit the Adjustment Mode then turn off the instrument.

Using the Front Panel for Adjustments





This section describes the process used to perform adjustments from the front panel.

Selecting the Adjustment Mode

Unsecure the instrument see [“Unsecuring the Instrument for Calibration”](#) on page 139 or [“To Unsecure the Instrument Without the Security Code”](#) on page 141. Once unsecured, the reference value will be indicated on the primary display.

Entering Adjustment Values

In the Handheld DMM adjustment procedures, to enter an input calibration value from the front panel:

- 1 Use the edit keys  and  to select each digit in the primary display.
- 2 Use the  and  arrow keys to advance through the digits 0 through 9.
- 3 Press  when done to start calibration.

Adjustments Consideration

You will need a test input cable and connectors set, and a Shorting Plug to adjust the instrument (see “[Input Connections](#)” on page 129).

NOTE

After each adjustment, the secondary display briefly shows PASS. If the calibration fails, the handheld multimeter sounds a beep, and an error number is shown in the secondary display. Calibration error messages are described on page 154. In the event of a calibration failure, correct the problem and repeat the procedure.

Adjustments for each function should be performed only in the order shown below.

- 1 Allow the instrument to warm up and stabilize for 5 minutes before performing the adjustments.
- 2 Assure that during the adjustment, the low battery indicator does not appear. Replace the batteries as soon as possible to avoid false reading.
- 3 Consider the thermal effects as you are connecting test leads to the calibrator and handheld multimeter. It is recommended to wait for one minute before you begin the calibration after connecting the test leads.
- 4 During ambient temperature adjustment, be sure the instrument has been turn on for at least 1 hour with K-type thermocouple connected between instrument and calibration source.

CAUTION

Never turn off the instrument during an adjustment. This may delete the calibration memory for the present function.

Valid Adjustment Input Values

Adjustment can be accomplished using the following input values below.

Table 6 Valid adjustment input values

Function	Range	Valid Amplitude Input Values
$\sim V$	5V, 50 V, 500 V, 1000 V	0.9 to 1.1 x Full Scale
$\equiv V$ (for U1251A)	5 V, 50 V, 500 V, 1000 V	0.9 to 1.1 x Full Scale
$\approx V$ (for U1252A)	5 V, 50 V, 500 V, 1000 V	0.9 to 1.1 x Full Scale
$\sim mV$	50 mV, 500 mV, 1000 mV	0.9 to 1.1 x Full Scale
$\mu A \sim$	500 μA , 5000 μA	0.9 to 1.1 x Full Scale
$mA \cdot A \sim$	50 mA, 440 mA, 5 A, 10 A	0.9 to 1.1 x Full Scale
Ω	500 Ω , 5k Ω , 50 k Ω , 500 k Ω , 5M Ω , 50 M Ω	0.9 to 1.1 x Full Scale
$\rightarrow \uparrow$ / TEMP	10 nF, 100 nF, 1000 nF, 10 μF , 100 μF , 1000 μF , 10 mF / 0 °C	Make sure to provide 0 °C with ambient compensation

Adjustment Procedure



Review the “[Test Considerations](#)” on page 128 and “[Adjustments Consideration](#)” on page 144 sections before beginning this procedure.

- 1 Turn the rotary switch to “Test Function” position, shown in the adjustment table.
- 2 After unsecuring the instrument, the instrument goes into the adjustment mode. (See “[Unsecuring the Instrument for Calibration](#)” on page 139)

NOTE

The instrument will be in the adjustment mode, unless Press SHIFT and  button simultaneously to exit the adjustment mode.

- 3 The primary display will show the reference value of the Cal Item.
- 4 Configure each Cal Item.

5 Use the  and  arrow keys to select the Cal Range.

6 Apply the input signal shown in the Input column of the table. The bar graph will display the Input reading. There is no bar graph display for temperature adjustment.

NOTE

Always complete tests in the same order as shown in the appropriate table.

- 7 Enter the actual applied input (see “[Entering Adjustment Values](#)” on page 143).
- 8 Press  to start the adjustment. The CAL flashes in the secondary display to indicate the calibration is in progress.



Successful completion of each adjustment value, the secondary display briefly showing PASS. An adjustment failure is sounded by a long beep and calibration error number appears in the secondary display. The primary display remains at the current Cal Item. Check the input value, range, function, and entered adjustment value to fix the problem and repeat the adjustment steps.



- 9 Repeat steps 1 through 8 for each adjustment point.
- 10 Verify the adjustments using the “[Performance Verification Tests](#)” on page 130.

7 Performance Tests and Calibration



Verify the adjustment with the following Table 6:



Table 6 Adjustment table

Step	Test Function	Cal Range	Input	Cal Item	
				U1251A	U1252A
1	Turn the rotary switch to the  V position	5V	0.3 V, 1 kHz	0.3000 V	0.3000 V
			3 V, 1 kHz	3.0000 V	3.0000 V
			3 V, 50 kHz	N/A	3.0000 V
		50V	3 V, 1 kHz	03.000 V	03.000 V
			30 V, 1 kHz	30.000 V	30.000 V
			30 V, 50 kHz	N/A	30.000 V
		500V	30 V, 1 kHz	030.00 V	030.00 V
			300 V, 1 kHz	300.00 V	300.00 V
			300 V, 50 kHz	N/A	300.00 V
		1000V	30 V, 1 kHz	0030.0 V	0030.0 V
			300 V, 1 kHz	0300.0 V	0300.0 V
			300 V, 50 kHz	N/A	0300.0 V
2	Turn the rotary switch to  V position (for model U1252A), to  V position (for model U1251A)	Short	Dual Banana Plug with copper wire short between 2 terminals	SHort	SHort
		5V	3 V	3.0000 V	3.0000 V
		50V	30 V	30.000 V	30.000 V
		500V	300 V	300.00 V	300.00 V
		1000V	1000 V	1000.0 V	1000.0 V







Step	Test Function	Cal Range	Input	Cal Item	
				U1251A	U1252A
3	Press  button to go to the  V mode	5 V	0.3 V, 1 kHz	N/A	0.3000 V
			3 V, 1 kHz	N/A	3.0000 V
			3 V, 50 kHz	N/A	3.0000 V
		50 V	3 V, 1 kHz	N/A	03.000 V
			30 V, 1 kHz	N/A	30.000 V
			30 V, 50 kHz	N/A	30.000 V
		500 V	30 V, 1 kHz	N/A	030.00 V
			300 V, 1 kHz	N/A	300.00 V
			300 V, 50 kHz	N/A	300.00 V
		1000 V	30 V, 1 kHz	N/A	0030.0 V
			300 V, 1 kHz	N/A	0300.0 V
			300 V, 50 kHz	N/A	0300.0 V
4	Turn the rotary switch to the  mV position	Short	Dual Banana Plug with copper wire short between 2 terminals	SHort	SHort
		50 mV	30 mV	30.000 mV	30.000 mV
		500 mV	300 mV	300.00 mV	300.00 mV
		1000 mV	1000 mV	1000.0 mV	1000.0 mV

7 Performance Tests and Calibration



Step	Test Function	Cal Range	Input	Cal Item	
				U1251A	U1252A
5	Press  button to go to the  mV mode	50mV	3 mV, 1 kHz	03.000 mV	03.000 mV
			30 mV, 1 kHz	30.000 mV	30.000 mV
			30 mV, 50 kHz	N/A	30.000 mV
		500mV	30 mV, 1 kHz	030.00 mV	030.00 mV
			300 mV, 1 kHz	300.00 mV	300.00 mV
			300 mV, 50 kHz	N/A	300.00 mV
		1000mV	30 mV, 1 kHz	0030.0 mV	0030.0 mV
			1000 mV, 1 kHz	1000.0 mV	1000.0 mV
			1000 mV, 50 kHz	N/A	1000.0 mV
6	Turn the rotary switch to the Ω position	Short	Dual Banana Plug with copper wire short between 2 terminals	SHort	SHort
		50 M Ω	Input terminal open (Remove any test leads and Short Plugs from the input terminal)	oPEn	oPEn
			10 M Ω	10.000 M Ω	10.000 M Ω
		5 M Ω	3 M Ω	3.0000 M Ω	3.0000 M Ω
		500 k Ω	300 k Ω	300.00 k Ω	300.00 k Ω
		50 k Ω	30 k Ω	30.000 k Ω	30.000 k Ω
		5 k Ω	3k Ω	3.0000 k Ω	3.0000 k Ω
		500 Ω	300 Ω	300.00 Ω	300.00 Ω

Step	Test Function	Cal Range	Input	Cal Item	
				U1251A	U1252A
7	Turn the rotary switch to the TEMP/  position	Open	Input terminal open (Remove any test leads and Short Plugs from the input terminal)	oPEn	oPEn
		10 nF	3 nF	03.000 nF	03.000 nF
			10 nF	10.000 nF	10.000 nF
		100 nF	10 nF	010.00 nF	010.00 nF
			100 nF	100.00 nF	100.00 nF
		1000 nF	100 nF	0100.0 nF	0100.0 nF
			1000 nF	1000.0 nF	1000.0 nF
		10 μ F	10 μ F	10.000 μ F	10.000 μ F
100 μ F	100 μ F	100.00 μ F	100.00 μ F		
1000 μ F	1000 μ F	1000.0 μ F	1000.0 μ F		
10 mF	10 mF	10.000 mF	10.000 mF		
8	Press  button to go to TEMP mode	N/A	0 °C	0000.0 °C	0000.0 °C
9	Turn the rotary switch to the  μ A position	OPEN	Input terminal open (Remove any test leads and Short Plugs from the input terminal)	oPEn	oPEn
		500 μ A	300 μ A	300.00 μ A	300.00 μ A
		5000 μ A	3000 μ A	3000.0 μ A	3000.0 μ A

7 Performance Tests and Calibration

10	Press  button to go to  μ A mode	500 μ A	30 μ A, 1 kHz 300 μ A, 1 kHz	030.00 μ A 300.00 μ A	030.00 μ A 300.00 μ A
		5000 μ A	300 μ A, 1 kHz 3000 μ A, 1 kHz	0300.0 μ A 3000.0 μ A	0300.0 μ A 3000.0 μ A
		Open	Input terminal open (Remove any test leads and Short Plugs from the input terminal)	oPEn	oPEn
		50 mA 440 mA	30 mA 300 mA	30.000 mA 300.00 mA	30.000 mA 300.00 mA
Move the test lead from μA.mA and COM terminal to A and COM terminal					
Caution: Connect calibrator to handheld multimeter's A and COM terminal before applying 3A and 10A					
		5 A	3 A	3.0000 A	3.0000 A
		10 A	10 A	10.000 A	10.000 A
Move the test lead from A and COM terminal to μA.mA and COM terminal					
12	Press  button to go to  mA mode	50 mA	3 mA, 1 kHz 30 mA, 1 kHz	03.000 mA 30.000 mA	03.000 mA 30.000 mA
		440 mA	30 mA, 1 kHz 300 mA, 1 kHz	030.00 mA 300.00 mA	030.00 mA 300.00 mA
		Open	Input terminal open (Remove any test leads and Short Plugs from the input terminal)	oPEn	oPEn
		5 A 10 A	3 A 10 A	3.0000 A 10.000 A	3.0000 A 10.000 A
Move the test lead from μA.mA and COM terminal to A and COM terminal					
Caution: Connect calibrator to handheld multimeter's A and COM terminal before applying 3A and 10A					
13	Press  button to go to  A mode	5 A	0.3 A, 1 kHz 3 A, 1 kHz	0.3000 A 3.0000 A	0.3000 A 3.0000 A
		10 A	3 A, 1 kHz 10 A, 1 kHz	3.0000 A 10.000 A	3.0000 A 10.000 A
		Open	Input terminal open (Remove any test leads and Short Plugs from the input terminal)	oPEn	oPEn
		5 A 10 A	3 A 10 A	3.0000 A 10.000 A	3.0000 A 10.000 A

Finishing the Adjustment

- 1 Remove all shorting plugs and connectors from the instrument.
- 2 Record the new Calibration Count.
- 3 Press  and  button simultaneously to exit the Adjustment Mode. Power off and on again. The instrument will then be secure.

To Read the Calibration Count



You can query the instrument to determine how many calibrations have been performed.

NOTE

Your instrument was calibrated before it left the factory.

When you receive your instrument, read the count to determine its initial value.

The count value increases by one for each calibration point, and a complete calibration will increase the value by many counts. The calibration count increments up to a maximum of 65535 after which it rolls over to 0. The calibration count can be read from the front panel after the instrument has been unsecured. Use the following procedures to read the calibration count from the front panel.

- 1 Press  Adjustment Mode. The primary display shows the calibration count.
- 2 Take note of the count.
- 3 Press  again to exit the calibration count mode.

Calibration Errors

The following errors indicate failures that may occur during a calibration.

Number	Recommended Accuracy Requirements
200	Calibration error: calibration mode is secured
002	Calibration error: secure code invalid
003	Calibration error: serial number code invalid
004	Calibration error: calibration aborted
005	Calibration error: value out of range
006	Calibration error: signal measurement out of range
007	Calibration error: frequency out of range
008	EEPROM write failure

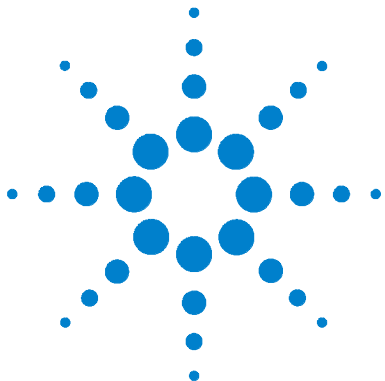

8 Specifications

DC Specifications	158
U1251A AC Specifications	160
U1252A AC Specifications	161
U1252A AC+DC Specifications	162
Temperature and Capacitance Specifications	163
U1251A & U1252A Frequency Specifications(1)	164
Operating Specifications	167
General Specifications	168

This chapter describes the handheld digital multimeter's specifications.



These specifications apply when using the U1251A and U1252A handheld digital multimeter in an environment that is *free* of electromagnetic interference and electrostatic charge.

When using the multimeter in an environment where electromagnetic interference or significant electrostatic charge *is* present, measurement accuracy may be reduced.

DC Specifications

Table 5 DC Accuracy \pm (% of reading + No. of Least Significant Digit)

Function	Range	Resolution	Test Current/ Burden Voltage	Accuracy	
				U1251A	U1252A
Voltage ⁽¹⁾	50.000 mV	0.001 mV	-	0.05+50 ⁽²⁾	0.05+50 ⁽²⁾
	500.00 mV	0.01 mV	-	0.03+5	0.025+5
	1000.0 mV	0.1 mV	-		
	5.0000 V	0.0001 V	-		
	50.000 V	0.001 V	-		
	500.00 V	0.01 V	-		0.03+5
	1000.0 V	0.1 V	-		
Resistance	500.00 Ω ⁽³⁾	0.01 Ω	1.04 mA	0.08+10	0.05+10
	5.0000 k Ω ⁽³⁾	0.0001 k Ω	416 μ A	0.08+5	0.05+5
	50.000 k Ω	0.001 k Ω	41.2 μ A		
	500.00 k Ω	0.01 k Ω	4.12 μ A		
	5.0000 M Ω	0.0001 M Ω	375 nA		
	50.000 M Ω ⁽⁴⁾	0.001 M Ω	187 nA	1+10	1+5
	500.00 M Ω ⁽⁴⁾	0.01 M Ω	187 nA	-	3+10<200M Ω / 8+10>200M Ω
	500.00 nS ⁽⁵⁾	0.01 nS	187 nA	1+20	1+10
Current	500.00 μ A	0.01 μ A	0.06 V (100 Ω)	0.1+5 ⁽⁶⁾	0.05+5 ⁽⁶⁾
	5000.0 μ A	0.1 μ A	0.6 V (100 Ω)	0.1+5 ⁽⁶⁾	0.05+5 ⁽⁶⁾
	50.000 mA	0.001 mA	0.09 V (1 Ω)	0.2+5 ⁽⁶⁾	0.15+5 ⁽⁶⁾
	440.00 mA	0.01 mA	0.9 V (1 Ω)	0.2+5 ⁽⁶⁾	0.15+5 ⁽⁶⁾
	5.0000 A	0.0001 A	0.2 V (0.01 Ω)	0.3+10	0.3+10
	10.000 A ⁽⁷⁾	0.001 A	0.4 V (0.01 Ω)	0.3+10	0.3+5
Diode Test	-	0.1 mV	1.04 mA	0.05 + 5	

- [1] Input impedance: $>1\text{G}\Omega$ for 50 mV to 1000 mV ranges. For U1251A, input impedance is $10\text{M}\Omega$ (nominal) for 5 V to 1000 V ranges. For U1252A, input impedance is $10\text{M}\Omega$ (nominal) in parallel with $1.1\text{M}\Omega$ at dual display.
- [2] The accuracy could be $0.05\%+10$ for U1251A and $0.05\%+5$ for U1252A. Always use NULL function to zero out the thermal effect before measuring the signal.
- [3] The accuracy of $500\ \Omega$ and $5\text{k}\Omega$ is specified after NULL function, which is used to subtract the test lead resistance and the thermal effect
- [4] For the range of $50/500\text{M}\Omega$, the R.H. is specified for $<60\%$.
- [5] The accuracy is specified for $<50\text{nS}$ and after NULL function with open test lead.
- [6] Always use NULL function to zero out thermal effect with open test lead before measuring the signal. If NULL function is not used, an additional 20 counts needs to be added to the DC current accuracy. Thermal effect could occur due to the following:
 - Wrong operation to measure the high voltage of 50 V to 1000 V for resistance, diode, and mV measurements.
 - After battery-charging has completed.
 - After measuring a current greater than 440 mA, it is suggested that the meter be left to cool down for twice the measuring time used.
- [7] Current can be measured up to 10 A continuously. An additional 0.5% needs to be added to the specified accuracy if the signal measured is in the range of 10 A to 20 A for 30 seconds maximum. After measuring a current of $>10\text{A}$, leave the meter to cool down for twice the measuring time used before application of low current measurement.

U1251A AC Specifications

Table 6 U1251A AC Accuracy \pm (% of reading + No. of Least Significant Digit)

Function	Range	Resolution	Frequency			
			30 Hz to 45 Hz	45 Hz to 1 kHz	1 kHz to 10 kHz	10 kHz to 30 kHz
True RMS AC Voltage ⁽¹⁾	50.000 mV	0.001 mV	1+60	0.6+40	1.0+40	1.6+60
	500.00 mV	0.01 mV	1+60	0.6+25	1.0+40	1.6+60
	1000.0 mV	0.1 mV	1+60	0.6+25	1.0+25	1.6+40
	5.0000 V	0.0001 V	1+60	0.6+25	1.0+25	1.6+40
	50.000 V	0.001 V	1+60	0.6+25	1.0+25	1.6+40
	500.00 V	0.01 V	1+60	0.6+25	1.0+25	1.6+40 ⁽²⁾
	1000.0 V	0.1 V	1+60	0.6+40	1.0+40	N/A

Function	Range	Resolution	Frequency		
			30 Hz to 45 Hz	45 Hz to 2 kHz	2 kHz to 20 kHz
AC Current	500.00 μ A ⁽³⁾	0.01 μ A	1.5+50	0.8+20	3+80
	5000.0 μ A	0.1 μ A	1.5+40	0.8+20	3+60
	50.000 mA	0.001 mA	1.5+40	0.8+20	3+60
	440.00 mA	0.01 mA	1.5+40	0.8+20	3+60
	5.0000 A	0.0001 A	2+40 ⁽⁵⁾	0.8+20	3+60
	10.000 A ⁽⁴⁾	0.001 A	2+40 ⁽⁵⁾	0.8+20	<3 A/5 kHz

[1] Input impedance: > 1GHz for 50 mV to 1000 mV. Input impedance is 1.1 M Ω (nominal) with <100 pF for 5 V to 1000 V ranges.

[2] The input signal is lower than the product of 20,000,000 V-Hz (product of voltage and frequency).

[3] Input current >35 μ Arms.

[4] Current can be measured from 2.5 A up to 10 A continuously. An additional 0.5% needs to be added to the specified accuracy if the signal measured is in the range of 10 A to 20 A for 30 seconds maximum. After measuring a current of >10 A, leave the meter to cool down for twice the measuring time used before application of low current measurement.

[5] Input current < 3 Arms.

U1252A AC Specifications

Table 7 U1252A AC Accuracy \pm (% of reading + No. of Least Significant Digit)

Function	Range	Resolution	Frequency				
			20 Hz – 45 Hz	45 Hz – 1 kHz	1 kHz – 10 kHz	10 kHz – 20 kHz	20 kHz – 100 kHz ⁽¹⁾
True RMS AC Voltage ⁽²⁾	50.000 mV	0.001 mV	1.5+60	0.4+40	0.7+40	0.75+40	3.5+120
	500.00 mV	0.01 mV	1.5+60	0.4+25	0.4+25	0.75+40	3.5+120
	1000.0 mV	0.1 mV	1.5+60	0.4+25	0.4+25	0.75+40	3.5+120
	5.0000 V	0.0001 V	1.5+60	0.4+25	0.4+25	0.75+40	3.5+120
	50.000 V	0.001 V	1.5+60	0.4+25	0.4+25	0.75+40	3.5+120
	500.00 V	0.01 V	1.5+60	0.4+25	0.4+25	1.5+40	3.5+120 ⁽³⁾
	1000.0 V	0.1 V	1.5+60	0.4+40	0.4+40	1.5+40 ⁽³⁾	N/A

Function	Range	Resolution	Frequency			
			20 Hz – 45 Hz	45 Hz – 1 kHz	1 kHz – 20 kHz	20 kHz – 100 kHz ⁽¹⁾
AC Current	500.00 μ A ⁽⁴⁾	0.01 μ A	1.0+20	0.7+20	0.75+20	5+80
	5000.0 μ A	0.1 μ A	1.0+20	0.7+20	0.75+20	5+80
	50.000 mA	0.001 mA	1.0+20	0.7+20	0.75+20	5+80
	440.00 mA	0.01 mA	1.0+20	0.7+20	1.5+20	5+80
	5.0000 A	0.0001 A	1.5+20 ⁽⁶⁾	0.7+20	3+60	N/A
	10.000 A ⁽⁵⁾	0.001 A	1.5+20 ⁽⁶⁾	0.7+20	<3 A/5 kHz	

[1] The additional error to be added as frequency >20 kHz and signal input <10 % of range: 3 counts of LSD per kHz.

[2] Input impedance: > 1GHz for 50 mV to 1000 mV. Input impedance is 1.1 M Ω (nominal) with <100 pF for 5 V to 1000 V ranges.

[3] The input signal is lower than the product of 20,000,000 V-Hz (product of voltage and frequency).

[4] Input current >35 μ Arms.

[5] Current can be measured from 2.5 A up to 10 A continuously. An additional 0.5% needs to be added to the specified accuracy if the signal measured is in the range of 10 A to 20 A for 30 seconds maximum. After measuring a current of >10 A, leave the meter to cool down for twice the measuring time used before application of low current measurement.

[6] Input current < 3 Arms.

U1252A AC+DC Specifications

Table 8 U1252A AC Accuracy \pm (% of reading + No. of Least Significant Digit)

Function	Range	Resolution	Frequency				
			30 Hz – 45 Hz	45 Hz – 1 kHz	1 kHz – 10 kHz	10 kHz – 20 kHz	20kHz – 100kHz ⁽¹⁾
Voltage ⁽²⁾	50.000 mV	0.001 mV	1.5+80	0.4+60	0.7+60	0.8+60	3.5+220
	500.00 mV	0.01 mV	1.5+65	0.4+30	0.4+30	0.8+45	3.5+125
	1000.0 mV	0.1 mV	1.5+65	0.4+30	0.4+30	0.8+45	3.5+125
	5.0000 V	0.0001 V	1.5+65	0.4+30	0.4+30	0.8+45	3.5+125
	50.000 V	0.001 V	1.5+65	0.4+30	0.4+30	0.8+45	3.5+125
	500.00 V	0.01 V	1.5+65	0.4+30	0.4+30	1.5+45	3.5+125 ⁽³⁾
	1000.0 V	0.1 V	1.5+65	0.4+45	0.4+45	1.5+45 ⁽³⁾	N/A

Function	Range	Resolution	Frequency		
			30 Hz – 45 Hz	45 Hz – 1 kHz	1 kHz – 20 kHz
Current	500.00 μ A ⁽⁴⁾	0.01 μ A	1.1+25	0.8+25	0.8+25
	5000.0 μ A	0.1 μ A	1.1+25	0.8+25	0.8+25
	50.000 mA	0.001 mA	1.2+25	0.9+25	0.9+25
	440.00 mA	0.01 mA	1.2+25	0.9+25	0.9+25
	5.0000 A	0.0001 A	1.8+30 ⁽⁶⁾	0.9+30	3.3+70 <3 A/5 kHz
	10.000 A ⁽⁵⁾	0.001 A	1.8+30 ⁽⁶⁾	0.9+25	

[1] The additional error to be added as frequency >20 kHz and signal input <10 %of range: 3 counts of LSD per kHz.

[2] Input impedance: > 1GHz for 50 mV to 1000 mV. Input impedance is 1.1 M Ω (nominal) with <100 pF for 5 V to 1000 V ranges.

[3] The input signal is lower than the product of 20,000,000 V-Hz (product of voltage and frequency).

[4] Input current >35 μ Arms.

[5] Current can be measured from 2.5 A up to 10 A continuously. An additional 0.5% needs to be added to the specified accuracy if the signal measured is in the range of 10 A to 20 A for 30 seconds maximum. After measuring a current of >10 A, leave the meter to cool down for twice the measuring time used before application of low current measurement.

[6] Input current < 3 Arms.

Temperature and Capacitance Specifications

Function	Thermocouple Type	Range	Resolution	Accuracy ± (% of reading + No. of Least Significant Digit)
Temperature ⁽¹⁾	K	-200 – 1372 °C/ -328 – 2502 °F	0.1 °C/ 0.1 °F	0.3 % +3 °C/ 0.3 % +6 °F
	J ⁽²⁾	-210 – 1200 °C/ -346 – 2192 °F	0.1 °C/ 0.1 °F	0.3 % +3 °C/ 0.3 % +6 °F

Function	Range	Resolution	Accuracy ± (% of reading + Offset Error)	Measuring Rate At Full Scale	Max. Display
Capacitance	10.000 nF	0.001 nF	1 % +8	4 times/sec.	11000 counts
	100.00 nF	0.01 nF	1 % +5		
	1000.0 nF	0.1 nF			
	10.000 µF	0.001 µF			
	100.00 µF	0.01 µF		3 % +10	
	1000.0 µF	0.1 µF	0.1 times/sec.		
	10.000 mF	0.001 mF	0.01 times/sec.		
	100.00 mF	0.01 mF			

[1] The accuracy is specified as following condition:

- The accuracy does not include the tolerance of thermocouple probe. The thermal sensor plugged into the meter should be placed in the operating environment for at least an hour.
- Use Null function to reduce the thermal effect. Before using NULL function, set meter to no ambient compensation (**nC**) mode and kept thermocouple probe as close to the meter as possible, avoiding contact with any surface that has a different temperature from ambient temperature.
- When measuring temperature with respect to any temperature calibrator, try to set both the calibrator and meter with external reference (without internal ambient compensation). If both calibrator and meter are set with internal reference (with internal ambient compensation), deviation may show between the readings of the calibrator and meter, due to differences in ambient compensation between calibrator and meter.

[2] Only available in U1252A.

U1251A & U1252A Frequency Specifications⁽¹⁾

Range	Resolution	Accuracy ± (% of reading + No. of Least Significant Digit)	Min. Input Frequency
99.999 Hz	0.001 Hz	0.02%+3 <600 kHz	1 Hz
999.99 Hz	0.01 Hz		
9.9999 kHz	0.0001 kHz		
99.999 kHz	0.001 kHz		
999.99 kHz	0.01 kHz		

U1251A Frequency Sensitivity During Voltage Measurement

Input Range (Maximum input for specified accuracy = 10 x Range or 1000 V)	Minimum Sensitivity (R.M.S. Sine-Wave)		Trigger Level For DC Coupling	
	20 Hz – 100 kHz	>100 kHz – 200 kHz	< 100 kHz	>100 kHz – 200 kHz
50.000 mV	10 mV	15 mV	10 mV	15 mV
500.00 mV	25 mV	35 mV	60 mV	70 mV
1000.0 mV	40 mV	50 mV	100 mV	150 mV
5.0000 V	0.25 V	0.5 V	0.5 V / 1.25 V (< 100 Hz)	0.6 V
50.000 V	2.5 V	5 V	5 V	6 V
500.00 V	25 V	N/A	50 V	N/A
1000.0 V	50 V	N/A	300 V	N/A

U1252A Frequency Sensitivity During Voltage Measurement

Input Range (Maximum input for specified accuracy = 10 x Range or 1000 V)	Minimum Sensitivity (R.M.S. Sine-Wave)		Trigger Level For DC Coupling	
	20 Hz – 200 kHz	>200 kHz – 500 kHz	< 100 kHz	>100 kHz – 500 kHz
50.000 mV	10 mV	25 mV	10 mV	25 mV
500.00 mV	70 mV	150 mV	70 mV	150 mV
1000.0 mV	120 mV	300 mV	120 mV	300 mV
5.0000 V	0.3 V	1.2 V	0.6 V	1.5 V
50.000 V	3 V	5 V	6 V	15 V
500.00 V	30 V < 100 kHz	N/A	60 V	N/A
1000.0 V	50 V < 100 kHz	N/A	120 V	N/A

[1] The input signal is lower than the product of 20,000,000 V-Hz.

U1251A & U1252A Frequency Sensitivity During Current Measurement

Input Range	Minimum Sensitivity (R.M.S. Sine-Wave) 20 Hz – 20 kHz
500.00 μ A	100 μ A
5000.0 μ A	250 μ A
50.000 mA	10 mA
440.00 mA	25 mA
5.0000 A	1 A
10.000 A	2.5 A

Duty Cycle⁽¹⁾

MODE	RANGE	ACCURACY AT FULL SCALE
DC Coupling	0.01 % – 99.99 %	0.3 % per kHz + 0.3 %

Pulse Width⁽¹⁾

MODE	RANGE	ACCURACY AT FULL SCALE
500 ms	0.01 ms	0.2 % + 3
2000 ms	0.1 ms	0.2 % + 3

[1] Positive or negative pulse width must be greater than 10 μ s and the range of duty cycle should be considered. The range of pulse width is determined by the frequency of the signal.

U1252A Frequency Counter Specifications

Divide 1 (secondary display “-1-”)

Range	Resolution	Accuracy \pm (% of reading + No. of Least Significant Digit)	Sensitivity	Min. Input Frequency
99.999 Hz	0.001 Hz	0.02%+3 0.002%+5, <2 MHz	100 mV R.M.S.	0.5 Hz
999.99 Hz	0.01 Hz			
9.9999 kHz	0.0001 kHz			
99.999 kHz	0.001 kHz		200 mV R.M.S.	
999.99 kHz	0.01 kHz			
9.9999 MHz	0.0001 MHz			

Divide 100 (secondary display “-100-”)

Range	Resolution	Accuracy ± (% of reading + No. of Least Significant Digit)	Sensitivity	Min. Input Frequency
9.9999 MHz	0.0001 MHz	0.002 % +5, <20 MHz	400 mV R.M.S.	1 MHz
99.99 MHz	0.001 MHz		600 mV R.M.S.	

PEAK HOLD (Capturing changes)

SIGNAL WIDTH	ACCURACY FOR DC mV/VOLTAGE/CURRENT
Single event > 1 ms	2% + 400 for all ranges
Repetitive > 250 μs	2% + 1000 for all ranges

U1252A SQUARE WAVE OUTPUT

OUTPUT ⁽¹⁾	RANGE	RESOLUTION	ACCURACY
FREQUENCY	0.5, 1, 2, 5, 10, 15, 20, 25, 30, 40, 50, 60, 75, 80, 100, 120, 150, 200, 240, 300, 400, 480, 600, 800, 1200, 1600, 2400, 4800 Hz	0.01Hz	0.005% +2
DUTY CYCLE⁽²⁾	0.39% – 99.60%	0.390625%	0.4% of full scale ⁽³⁾
PULSE WIDTH⁽²⁾	1/Frequency	Range/256	0.2 ms + Range/256
AMPLITUDE	Fixed 0 to +2.8 V	0.1 V	0.2 V

[1] Output impedance: 3.5 kΩ maximum.

[2] The positive or negative pulse width must be greater than 50 μs for adjusting the duty cycle or pulse width under different frequency. Else, the accuracy and range will be different from the definition.

[3] For signal frequencies greater than 1 kHz, an addition of 0.1% per kHz is added to the accuracy.

Operating Specifications

Measuring rate

Function	Times/second
ACV	7
ACV + dB	7
DCV	7
ACV	7
AC + DC V	2
Ω/nS	14
Diode	14
Capacitance	4 (< 100 μF)
DCI	7
ACI	7
AC + DC I	2
Temperature	6
Frequency	2 (>10 Hz)
Duty cycle	1 (>10 Hz)
Pulse width	1 (>10 Hz)

General Specifications

<p>Display</p> <ul style="list-style-type: none"> Both primary and secondary displays are 5-digit liquid crystal display (LCD) with maximum reading of 50,000 counts. Automatic polarity indication.
<p>Power Consumption</p> <ul style="list-style-type: none"> 105 mVA / 420 mVA (with backlit) maximum (U1251A) 165 mVA / 480 mVA (with backlit) maximum (U1252A)
<p>Operating Environment</p> <ul style="list-style-type: none"> Full accuracy at -20 °C to 55 °C Full accuracy to 80 % RH for temperature up to 35 °C, decreasing linearly to 50 % RH at 55 °C <p>Altitude:</p> <ul style="list-style-type: none"> 0 - 2000 meters per IEC 61010-1 2nd Edition CAT III, 1000 V 2000 - 3000 meters per IEC 61010-1 2nd Edition CAT III, 600 V
<p>Storage Compliance</p> <ul style="list-style-type: none"> -40 °C to 70 °C
<p>Safety Compliance</p> <ul style="list-style-type: none"> EN/IEC 61010-1:2001, UL 61010-1 Second Edition and CAN/CSA 22.2 61010-1 Second Edition
<p>Measurement Category</p> <ul style="list-style-type: none"> CAT III 1000 V Overvoltage Protection up to 2000m, Pollution degree 2
<p>EMC Compliance</p> <ul style="list-style-type: none"> Certified to IEC/EN 61326: 2002, CISPR 11, and equivalents for Group 1, Class A
<p>Common Mode Rejection Ratio (CMRR)</p> <ul style="list-style-type: none"> > 90 dB at DC, 50/60 Hz + 0.1 % (1 kΩ unbalanced)
<p>Normal Mode Rejection Ratio (NMRR)</p> <ul style="list-style-type: none"> > 60 dB at DC, 50/60 Hz + 0.1 %
<p>Temperature Coefficient</p> <ul style="list-style-type: none"> 0.15 * (specified accuracy)/ °C (from -20 °C to 18 °C or 28 °C to 55 °C)
<p>Shock and Vibration</p> <ul style="list-style-type: none"> Tested to IEC/EN 60068-2
<p>Dimension (HxWxD)</p> <ul style="list-style-type: none"> 203.5 mm x 94.4 mm x 59.0 mm
<p>Weight</p> <ul style="list-style-type: none"> 504±5 grams with battery (U1251A) 527±5 grams with battery (U1252A)
<p>Charging Time (only U1252)</p> <ul style="list-style-type: none"> < 220 minutes approx. at the environment of 10 °C to 30 °C.
<p>Warranty</p> <ul style="list-style-type: none"> 3 years